

Multi-Functional Display

Version: 3.00.340

ECDIS User Manual

Date of Issue: February 2016

TRANSAS

Copyright: © Transas MIP Ltd 1991–2016. All rights reserved.

The information contained herein is proprietary to Transas MIP Ltd and shall not be duplicated in whole or in part. The technical details contained in this manual are accurate at the date of issue but are subject to change without notice.

Transas MIP Ltd pursues a policy of continuous development. This may mean that the product delivered has additional enhancements not yet covered by the latest version of this manual.

The names of actual companies and products mentioned herein may be the trademarks of their respective owners.

Table of Contents

Table of Contents	3
Printing House Conventions	10
List of Documents	10
Preamble	11
Annotation	12
Definitions and Abbreviations	12
Definitions	12
Abbreviations	15
Purpose of ECDIS Task	18
Chapter 1. ECDIS User Interface	19
ECDIS User Interface Structure	21
Main and Dual Chart Panels	22
Chart Areas	23
Toolbars	23
User Interface Components	25
Panels	25
Pages	27
Control Panel Windows	27
List Box Menu	28
Text Boxes	28
Buttons	28
Radio Buttons	29
Indicators	29
Progress Bars	29
ECDIS Task Control Panel	30
COG/SOG/HDG/STW Window	31
Alerts Window	32
Application Window	32
Position Dropped Window	32
Sensors Window	33
Vectors Window	33
Network Window	33
Indications Window	34
Time Window	34
Primary Window	34

Secondary Window	35
Charts Area Window	36
Display Panel Window	36
Operational Window	37
EBL/VRM/CHL Window	37
Information Window	38
Abbreviations Used in the User Interface	38
Use of Uniform Measurement Units	39
Keyboard	40
Virtual Keyboard	43
Chapter 2. ECDIS Task Turning On/Off	45
Turning the ECDIS Task On	46
Turning the ECDIS Task Off	47
Chapter 3. ECDIS Task Control	49
Transfer of Rights	50
Turning On/Off Control and Conning Panels Display on the ECDIS Task Screen	50
Setting Control Panel Windows Display	52
Setting of Measurement Units	53
ECDIS Task Screen Configuration	54
Setting of Screen Colour Palette	54
Setting of Screen Graphic Presentation	55
Switching the Graphic Cursor Type	56
Setting of Screen Boundaries Re-Draw as the Ship Symbol Approaches Them	56
Chart Panel Settings	56
Setting of Main and Dual Panel Displays	56
Setting of Ship Symbol on the Chart Panel by the Cursor Position	58
Setting Chart Panel Orientation	59
Setting Ship Symbol Motion Modes	59
Setting Ship Display and Its Motion Parameters on the ECDIS Task Screen	60
Setting of the Lengths of the Own Ship and Targets Vectors	61
Setting Time Zone	61
Setting Current Time Zone	62
Setting Time Zone Change	62
Use of ECDIS Task Tools	63
Return of Own Ship Symbol Display to the ECDIS Task Screen	63
Viewing Charts	63
ERBL	64
Zoom	65
Using Touchscreen Functions	66
EBL/VRM	70
Index Lines	70
Quick Distance Tool	72
Manual Entry in the Ship Log	73
Chapter 4. Navigation Tasks	75
Setting Position Sources	77

Setting Electronic Position Fixing System (EPFS)	77
Setting ER Mode	81
Setting EP Mode	86
Setting DR Mode	87
Display of Non-Primary Positioning System Symbol on ECDIS Task Screen	89
Use of Manually Fix Position for Determining Ship Position	90
Setting Heading Source	97
Setting Speed Sources	98
Setting Speed Source Through the Water	99
Setting Speed Source Over the Ground	100
Setting Depth Source	101
Obtaining Current Information about Navigational Data	102
Loading of Route and Schedule in the Navigation Mode	104
Setting Lead Distance (F-dist)	104
Loading Route	105
Selection of Safety Parameters when Loading Monitored Route	109
Loading Schedule	112
Obtaining Current Information about Monitoring Route and Schedule	114
Route Data	114
Schedule Information	115
Unloading Route and Schedule	117
Handling Charts and Chart Information	118
Prompt Search and Load Charts	118
Loading and Scaling Charts under Own Ship Position	119
Chart Loading	121
Selecting Loading Priority of Various Format Charts	122
Chart Scaling	123
Switching Chart Information Layers	125
Handling ENC Format Charts	129
Handling AIO Chart	131
Handling TODO Charts	135
Using Auto Zoom Function	137
Using the Mooring Mode	138
Search and Rescue Operations	139
Using Man Overboard (MOB) Mode	139
Creating SAR Routes	142
Expanding Square Route	143
Parallel Tracks Route	144
Sector Search Route	145
Track Line Search Route	146
Creeping Line Search Route	147
Using Special Purpose Objects	149
SPO Creating	150
SPO Deleting	152
Other Functions	152

Saving and Loading SPO Configuration	153
Chapter 5. Setting of Safety Parameters	155
Monitoring of Sailing along the Route and by the Schedule	156
Monitoring of Safety Alerts	158
Setting of Safety Parameters for the Detection of Dangerous Objects	158
Setting of Safety Parameters in the Sailing in the Vicinity of Dangerous Objects	161
Monitoring of Crossing of Area Limits in IMO and Additional Groups	162
Safety Tools	163
Clearing Bearing	163
Creating Clearing Bearing	164
Clearing Bearing Editing	167
Fast Clearing Bearing Search	169
Deleting Clearing Bearing	170
Saving and Loading Configuration	170
Monitoring of Navigational Alerts	172
Monitoring of Time	174
Setting of End-of-Watch Alerts	175
Setting of the Timer	175
Chapter 6. Using Logging Functions	177
Using Ship Logbook	178
User Accounts Creation	179
Search for Events in Ship LogBook	181
Events Filtering	182
Custom Events Creation	183
Event Entering and Editing	185
The Ship Logbook Editing	191
Separating Voyages	192
Work with Archive	194
Ship Logbook Printout	196
Using Electronic System Logbook	200
Own Ship Track in the ECDIS Task	204
Setting Track Display Elements	204
Viewing Archive Tracks	207
Chapter 7. Manual Updating	209
Turning On/Off the Display of Updating Objects and Their Attributes	210
Creating and Plotting Updating Objects	211
Plotting Point Type Objects	212
Plotting Circles and Circumferences	214
Plotting Lines and Areas	216
Plotting Text Object	218
Plotting Depth Object	220
Assigning "Attached File" Attribute	222
Editing Updating Objects	224
Editing Updating Objects Attributes	224
Editing Object Coordinates	226

Deleting Updating Object	228
Restore the Deleted Object	229
Search for Updating Objects	231
Chapter 8. Handling of Maps	235
Creating and Saving Maps	236
Creating and Plotting Map Objects	238
Plotting Symbol Type Objects	238
Plotting Lines	241
Plotting Text Object	243
Plotting Depth Object	244
Plotting Shapes	246
Assigning “Attached File” Attribute	253
Saving Map	255
Turning On/Off Display of Map Objects and Their Attributes	255
Map Loading and Unloading for Editing	256
Map Loading and Unloading for Monitoring	260
Editing Map Objects	263
Editing Map Object Attributes	263
Editing Map Object Coordinates	265
Deleting Map Object	267
Restoring Deleted Map Object	268
Merging Maps	269
Deleting Maps	272
Search for Map Objects	273
Map Handling in Network Configuration	274
Chapter 9. Handling of Routes	277
Work with Route	278
Default Route Settings	278
Creating a Route	279
Selecting Cursor Form	279
Plotting Route	281
Entering Additional Data	283
Route Loading and Unloading	286
Fast Route Search	287
Anchoring Operations	288
Anchorage Planning in Route Plotting	288
Anchoring in Route Monitoring Mode	292
Editing the Route	295
Graphic Route Editing Method	295
Tabular Route Editing Method	299
Shifting a Route	301
Creating Reversed Route	303
Merging Routes	303
Deleting a Route	303
Checking and Editing the Route Taking into Account Dangers to Navigation	304

Route Approval and Protection	308
Protecting Route from Editing	308
Route Approval	310
Routes Exchange with SPOS	311
Work with Schedule	313
Drawing a Schedule	313
Editing a Schedule	316
Deleting a Schedule	317
Voyage Plan Creation	317
Data Collection	317
Obtaining Information on Sun/Moon on the Route	319
Voyage Plan Data Edition	320
Setting and Changing Reference Points	320
Deleting Reference Points	323
Search for Reference Point	324
Voyage Plan Print Preview and Printing	324
Exporting Voyage Plan	326
Chapter 10. Handling Radar Information and Target Designation Units	327
Radar Overlay	328
Work with Radar Overlay	328
Distance and Bearing Offset	331
Introduction	331
Distance and Bearing Offset Setting	331
ARPA	333
Target Display	333
Turning On/Off External ARPA Tools	335
ARPA Settings	336
To Acquire Targets for Tracking	336
To Cancel Tracked Targets	337
To Turn on Ring Shaped Guard Zones	338
To Set Guard Zone Limits	339
To Turn Off Guard Zones	341
AIS	342
Handling AIS Targets	342
AIS Target Display	342
Display of AIS Target Identifiers	343
Display of Target Tracks	344
Prompt Target Search	345
Setting of Voyage Data	345
Transmission of Messages in AIS System	348
Reception of Messages in AIS System	351
Using AIS Safety Messages Database	354
Handling Targets	355
Setting of Safety Parameters in the Tracking of Targets	355
Handling Target Table	356

Prompt Target Search	357
Turning On Mode of Associating AIS and ARPA Targets	359
Turning On DR Mode for AIS Targets	360
Filtering Lost Targets	362
Filtering AIS Targets	363
Obtaining Information on Target	365
Chapter 11. Obtaining of Information in the ECDIS Task	367
Obtaining Information on Vector Chart Objects	369
Obtaining Information on Point Type Objects	369
Obtaining Information on Line and Area Type Objects	370
Obtaining Information on Vector Charts	371
Obtaining Information on Updating Objects	372
Obtaining Information on Map Objects	373
Obtaining Information on Tides and Currents	374
Obtaining Information on the Change of Tidal Heights	374
Information Displayed Graphically	376
Information Displayed in a Tabular Form	377
Display of Tidal Heights on the Chart Panel	379
Obtaining Information on Tidal Currents	380
Obtaining Information on Surface Currents	381
Use of Animation	382
Obtaining Information on Sun/Moon	384
Obtaining Current System Information	387
Obtaining Information on Ports	389
Obtaining Information by Port Name	389
Obtaining Information by the Region Name	390
Obtaining Information by the Country Name	391
Obtaining Information by the Cursor Position on the Chart Panel	392
Quick Search for Selected Port	393
Obtaining NAVTEX Information	394
Work with NAVTEX Message Database	394
Work with Messages	398
Setting NAVTEX Message Status and Attributes	398
Editing Coordinates in NAVTEX Message	399
Fast Search for NAVTEX Message Symbol on the Chart Panel	401
Obtaining Information on Own Ship AIS Data	401
Obtaining Information on Currently License	402
Obtaining Information on Input/Output Messages	403
Display of Data Flow Between the MFD and Different External Devices	404
COM Trace Record	405

Printing House Conventions

Sample of notation	Usage comments
Setup.exe	Messages, commands, files, folders and other Windows OS info
<Enter>	Keyboard key names
Button	Buttons
Interface	Names of windows, pages, panels
Menu	Menu items
Ahead	User interface elements and the ECDIS task objects
<i>Multi-Functional Display (v. 3.00.340). ECDIS User Manual</i>	Names and sections of documents
Note, Warning, Caution	Note, Warning, Caution
Auxiliary text	Auxiliary text
<i>Cross reference</i>	Cross reference
http://www.amver.com	URL

Table 1. Printing House Conventions

List of Documents

- Multi-Functional Display (v. 3.00.340). ECDIS User Manual.
- Multi-Functional Display (v. 3.00.340). RADAR User Manual .
- Multi-Functional Display (v. 3.00.340). Functional Description.
- Multi-Functional Display (v. 3.00.340). Additional Functions.
- Multi-Functional Display (v. 3.00.340). ECDIS Quick Reference.
- Multi-Functional Display (v. 3.00.340). RADAR Quick Reference.
- Multi-Functional Display (v. 3.00.340). Installation Guide Part I.
- Multi-Functional Display (v. 3.00.340). Installation Guide Part II.
- Multi-Functional Display (v. 3.00.340). Utilities.
- Navi-Sailor 4100 ECDIS (v. 2.00.348). Special Functions.
- Navi-Planner 4000 (v. 3.00.346). User Manual.

Preamble

Preamble provides general information on the work with document.

<u>Annotation</u>	12
<u>Definitions and Abbreviations</u>	12
Definitions	12
Abbreviations	15
<u>Purpose of ECDIS Task</u>	18

Annotation

The aim of this book is to provide the user with guidelines in the solution of various tasks, which may arise during the voyage, and to give the user some ideas of the operating principles and capabilities of ECDIS task.

The description is divided into 11 parts:

- Chapter 1. ECDIS User Interface.
- Chapter 2. ECDIS Task Turning On/Off.
- Chapter 3. ECDIS Task Control.
- Chapter 4. Navigation Tasks.
- Chapter 5. Setting of Safety Parameters.
- Chapter 6. Using Logging Functions.
- Chapter 7. Manual Updating.
- Chapter 8. Handling of Maps.
- Chapter 9. Handling of Routes.
- Chapter 10. Handling Radar Information and Target Designation Units.
- Chapter 11. Obtaining of Information in the ECDIS Task.

Definitions and Abbreviations

Definitions

Activated AIS target

Target activated for the display of additional graphically presented information.

Appropriate portfolio of up to date paper charts (APC)

A suite of paper charts of a scale to show sufficient detail of topography, depths, navigational hazards, aids to navigation, charted routes, and routeing measures to provide the mariner with information on the overall navigational environment.

CIE Colour Calibration

Colour calibration at the monitor performed to transform the CIE-specified colours for ECDIS into the colour coordinate system of the screen

Common Reference System

Means provided to assure that when navigational information from sensors and other information sources is displayed together with charted information, it is referenced to a consistent common reference point (CCRP).

Compilation Scale

The scale at which the data was compiled.

Corrupted Data

ENC data produced according to the IHO S-57 ENC product specification, but altered or modified during production, transmission, or retrieval.

Dangerous Target

Tracked radar or reported AIS target with a predicted CPA and TCPA that violates values preset by the user. The respective target is marked by a “dangerous target” symbol.

Dead-Reckoned Position (DR)

Position extrapolated from the last accepted position update, based on present course and speed, and updated on a time interval selected by the operator.

Degrade

Reduce the quantity or quality of information content.

Display Base

The chart content as listed in Annex A and which cannot be removed from the display. It is not intended to be sufficient for safe navigation.

Display Redraw Time

Interval from when the display starts to change until the new display is complete.

Display Regeneration Time

Interval from operator action until the consequent redraw is complete.

Display Scale

Ratio between a distance on the display and a distance on the ground, normalized and expressed as, for example, 1:10 000.

Electronic Chart Display and Information System (ECDIS)

Navigation information system which with adequate backup arrangements can be accepted as complying with the up-to-date chart required by regulation V/19 and V/27 of the 1974 SOLAS Convention, as amended, by displaying selected information from a system electronic navigational chart (SENC) with positional information from navigation sensors to assist the mariner in route planning and route monitoring, and if required display additional navigation related information.

Electronic Navigational Chart (ENC)

The database, standardized as to content, structure and format, issued for use with ECDIS by or on the authority of a Government authorized Hydrographic Office or other relevant government institution, and conform to IHO standards.

ENC Cell

The basic unit of ENC data covering a defined geographical area bounded by two meridians and two parallels

ENC Data

Data conforming Electronic Navigational Chart (ENC)

ENC Test Data Set

Standardized data set and testing instructions available as IHO S-64.

Estimated position (EP)

Position extrapolated from the last accepted position update, based on present course and speed (STW), including effects of wind, tide, current, and updated on a time interval selected by the operator.

Fix

Position of own ship determined, without reference to any former position, by the common intersection of two or more LOPs.

Important Indication

Indication that is displayed visually and continuously, which needs special attention and cannot be removed from the display other than by eliminating the cause of the indication.

Indication

Display of regular information and conditions, not part of alert management.

Line of Position (LOP)

Plotted line on which own ship is located determined by observation or measurement of the range or bearing to an aid to navigation or other charted element.

Lost Target

Tracked radar or reported AIS target for which the system is no longer receiving valid position data.

Non-ENC Data

Data not conforming to ENC data.

Official

By, or on authority of a government, authorized Hydrographic Office or other relevant government institution.

Overscale

Display of the chart information at a display scale larger than the compilation scale.

Readily Available Indication

Indication that can be, at any moment, immediately displayed by a single operator action.

Presentation Library

Implementation of the display specifications in IHO S-52, Annex A, by de-coding and symbolizing the SENC.

Raster Chart Display System (RCDS)

A navigation information system displaying RNCs with positional information from navigation sensors to assist the mariner in route planning and route monitoring and, if required, display additional navigation-related information.3.1.31

Raster Navigational Chart (RNC)

A facsimile of a paper chart originated by, or distributed on the authority of, a government-authorized Hydrographic Office.

RTS

Reported Target Simulator as defined in Annex F of IEC.

Route

Series of waypoints connected by one or more legs including both straight and curved segments.

RNC Data

Data Conforming to Raster Chart Display System (RCDS).

RNC Test Data Set

Standardized data set and testing instructions available as IHO S-64.

Single Operator Action

Procedure achieved by no more than one hard-key or soft-key action, excluding any necessary cursor movements, or voice actuation using programmed codes.

Safety Contour

Borderline between safe and unsafe water based on depth defined by the mariner.

Safety Depth

Depth defined by the mariner, e.g. the ships draught plus under keel clearance, to be used by ECDIS to emphasise sounding on the display equal to or less than this value.

Selected Target

Target selected manually or automatically for the display of detailed alphanumeric data, information and text in a separate user dialogue area. The target is represented by a “selected target” symbol.

Sleeping AIS Target

AIS target indicating the presence of a vessel equipped with AIS in a certain location. The target is represented by a “sleeping target” symbol indicating the vessel’s orientation. No additional information is presented until the AIS target is activated.

Standard Display

The display mode intended to be used as a minimum during route planning and route monitoring.

System Electronic Navigational Chart (SENC)

A database in the manufacturer’s internal ECDIS format, resulting from the lossless transformation of the entire ENC contents and updates.

System Raster Navigational Chart (SRNC)

A database resulting from the transformation of the RNC by the RCDS to include updates to the RNC by appropriate means.

Abbreviations

- AIS – Automatic Identification System;
- ARCS – Admiralty Raster Chart System;
- ARPA – Automatic Radar Plotting Aid;
- BAM – Bridge Alert Management;
- BNWAS – Bridge Navigational Watch Alarm System;
- BWOL – Bearing to Wheel Over Line;
- BWW - Bearing Waypoint to Waypoint;
- CCRP – Consistent Common Reference Point;
- CIE – International Commission on Illumination;
- CMG – Course Made Good;
- COG – Course Over Ground;
- CPA – Closest Point of Approach;
- DGPS – Differential Global Positioning System;

- DR – Dead Reckoning;
- DWOL – Distance to Wheel Over Line;
- EBL – Electronic bearing line;
- ECDIS – Electronic Chart Display and Information System;
- EML – Expected Motion Line;
- ENC – Electronic Navigational Chart;
- EP – Estimated Position;
- EPFS – Electronic Position-Fixing System;
- ER – Echo Reference;
- ERBL – Electronic Range and Bearing Line;
- ETA – Estimated Time of Arrival;
- ETD – Estimated Time of Departure;
- GC – Great Circle;
- GMT – Greenwich Mean Time;
- GPS – Global Positioning System;
- GZ – Guard Zone;
- HCRF – Hydrographic Chart Raster Format
- HDG – Heading;
- HO – Hydrographic Office;
- IEC – International Electrotechnical Commission;
- IHO – International Hydrographic Organization;
- IMO – International Maritime Organisation;
- INFO – Information;
- m – metre;
- min – minute;
- MMSI – Maritime Mobile Service Identities;
- MSI – Maritime Safety Information;
- MOB – Man Overboard;
- NAVTEX – Navigational Telex;
- NM – Nautical Mile;
- NMEA – National Marine Electronics Association;
- NS – Navi-Sailor;
- PS – Positioning System;
- PTA – Planning Time of Arrival;
- RCDS – Raster Chart Display System;

-
- RIB – Radar Integrated Board;
 - RL – Rhumb Line;
 - RMS – Route Mean Square (error);
 - RNC – Raster Navigational Chart;
 - ROT – Rate Of Turn;
 - RPM – Revolution Per Minute;
 - SENC – System Electronic Navigational Chart;
 - SOLAS – Safety of Life at Sea;
 - SAR – Search And Rescue;
 - sec – second;
 - SMG – Speed Made Good;
 - SOG – Speed Over Ground;
 - STG – Speed To Go;
 - TCPA – Time to Closest Point of Approach;
 - TTG – Time To Go;
 - UTC – Universal Time Coordinated;
 - VDR – Voyage Data Recorder;
 - VRM – Variable Range Marker;
 - WGS-84 – World Geodetic Datum;
 - WOL – Wheel Over Line;
 - WPT – Way Point;
 - WS – Work Station;
 - XTD – Cross Track Distance.

Purpose of ECDIS Task

The main purpose of the ECDIS task is to:

- display on the electronic charts;
- display the ship position on the electronic chart;
- monitoring of approach to the dangers to navigation plotted on electronic vector charts or on map created by navigator;
- route planning and drawing up the schedule of proceeding along this route;
- solution of various kinds of navigational tasks (Navtex database, Tide & Currents database, SAR routes).

The ECDIS task is compliant with the IHO Standards, which are specified on the Transas website <http://www.transas.com/products/navigation/ecdis/ECDIS#compliance>.

Chapter 1.

ECDIS User Interface

This chapter describes principles of building the ECDIS user Interface

<u>ECDIS User Interface Structure</u>	21
Main and Dual Chart Panels	22
<u>User Interface Components</u>	25
Panels	25
Pages	27
Control Panel Windows	27
List Box Menu	28
Text Boxes	28
Buttons	28
Radio Buttons	29
Indicators	29
Progress Bars	29
<u>ECDIS Task Control Panel</u>	30
COG/SOG/HDG/STW Window	31
Alerts Window	32
Application Window	32
Position Dropped Window	32
Sensors Window	33
Vectors Window	33
Network Window	33
Indications Window	34
Time Window	34
Primary Window	34
Secondary Window	35
Charts Area Window	36
Display Panel Window	36
Operational Window	37
EBL/VRM/CHL Window	37
Information Window	38

<u>Abbreviations Used in the User Interface</u>	38
<u>Use of Uniform Measurement Units</u>	39
<u>Keyboard</u>	40
<u>Virtual Keyboard</u>	43

ECDIS User Interface Structure

In the ECDIS task, to enable the display of electronic charts and associated information, **Main** and **Dual** panels are used. The essential and other data and control tools are arranged on the Control panel. The rest of information and functionality for the control of the ECDIS environment is contained on functional panels. The panel layout can be presented diagrammatically as shown below:

- For monitors 19, 23 inches:

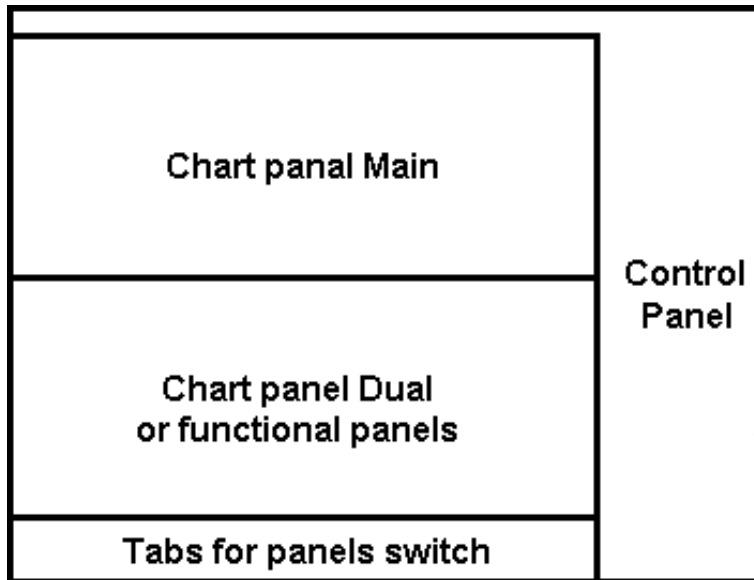

- For monitors 24, 26 and 27 inches:

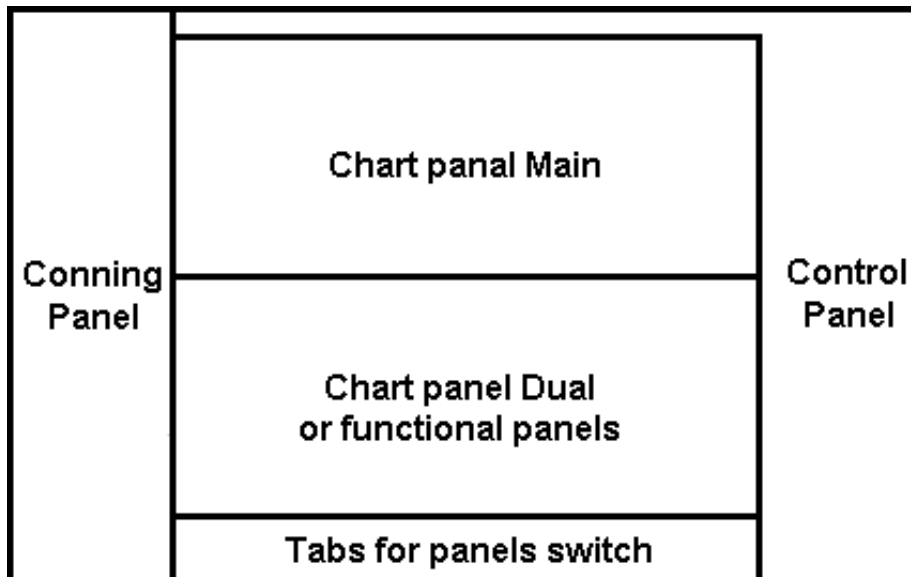

For Conning Panel windows description, see document *Multi-Functional Display (v. 3.00.340). Additional Functions, Chapter 3*.

Main and Dual Chart Panels

The **Main** panel is always displayed on the ECDIS task screen. The **Dual** panel or only one functional panel can be displayed simultaneously with the **Main** panel.

You can change vertical dimensions of functional panels and of **Dual** chart panel by using the cursor. As the cursor is positioned on the bottom boundary of the **Main** panel, it will change its form, then get hold of the boundary and set it at the desired height. If the two Chart panels are arranged vertically, this functionality is retained for altering horizontal dimensions (this arrangement is possible for Chart panels only).

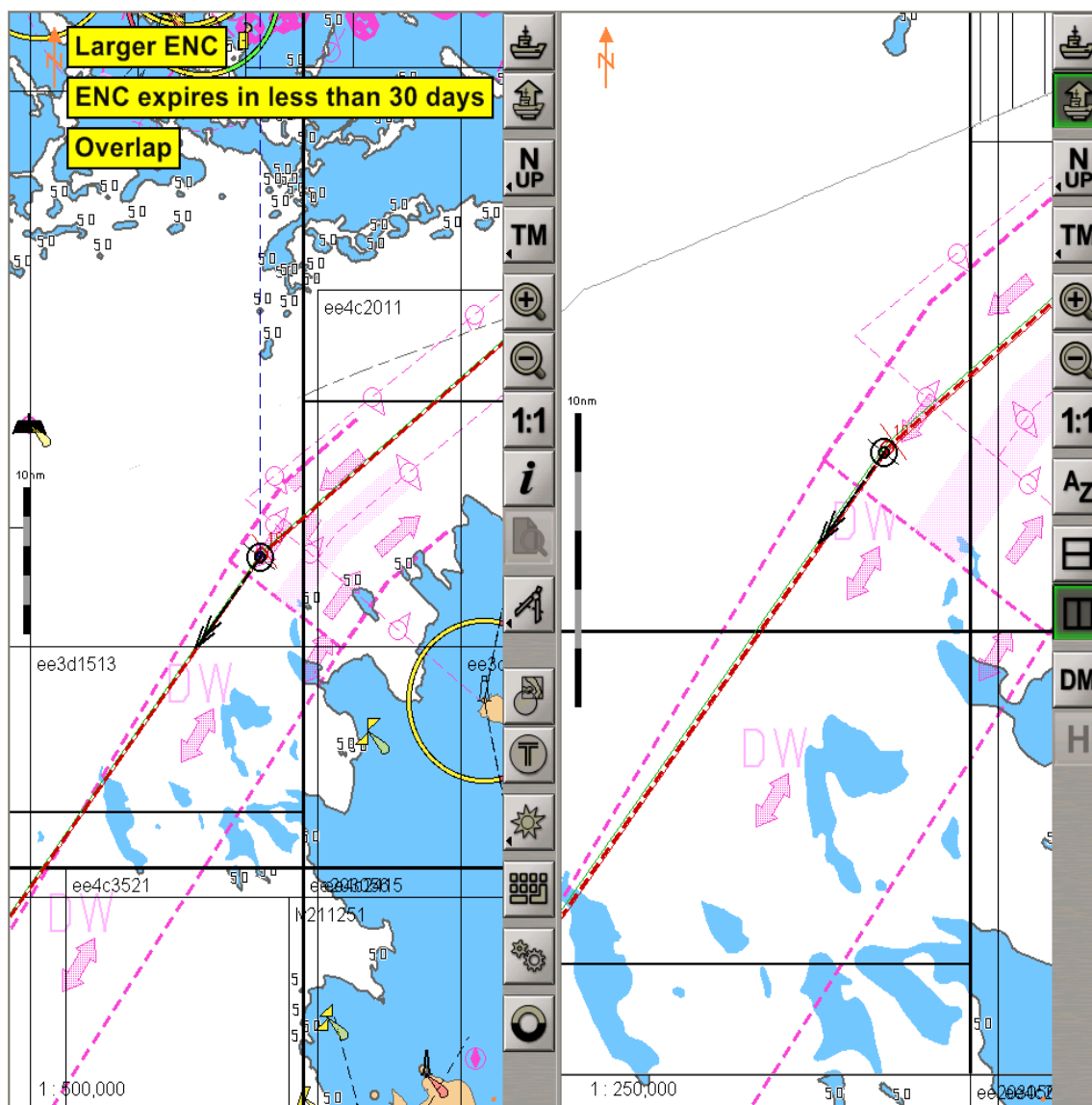

The **Main** panel is the principal Chart panel.

The **Dual** panel is an additional Chart panel where the ship symbol is permanently displayed. The panel is not displayed if any of functional panels are turned on (activated), and vice versa: when it is displayed, no functional panels can be seen.

The panels consists of two areas:

- Chart Area;
- Toolbar.

Chart Areas

The Chart Area of the each panels (**Main** and **Dual**) is designed for the following purposes:

- to display electronic charts showing classes of chart information (determined on **Charts** panel);
- to display the ownship symbol with motion vectors;
- to display the route loaded for proceeding by in the Navigation Mode;
- to display the AIS objects (only **Main** panel).

Displayed in the top left corner of the Chart Area is the panel orientation symbol  : an arrow showing direction to the north.

The bottom right corner of the electronic chart displays an angle shaped indicator .

The line is a graphic presentation of the maximum possible error of plotting objects on the chart. When a chart is displayed on the scale of the original, the linear size of the error is taken to be 2 mm. As the scale is growing, the linear dimensions of the indicator increase showing to which extent the chart information can be relied on.

Toolbars

The toolbar of **Main** chart panel contains the following control buttons:



- to return to the display of the ownship symbol;



- to set the ship symbol in the position of the cursor which appears when this mode is turned on;



- to select chart display orientation (North Up/Head Up/Course Up);



- to select ship symbol motion mode (True/Relative);



- to increase the chart display scale by the fixed scale value;



- to decrease the chart display scale by the fixed scale value;



- to display the chart on the original scale;



- to call Info cursor for obtaining information;



- to display HCRF format chart viewing panel;

 - to turn on/off Quick Distance Tool and select the mode of distance measurement;

 - to turn on the display of the chart over the radar picture;

 - to open **Transas Integrator** toolbar;

 - to select the screen colour palette to suit the outside illumination;

 - to turn on/off virtual keyboard.

 - to load (create/edit) User Configurations;

 - to turn on/off MOB mode.

The toolbar of **Dual** chart panel contains the following control buttons:

 - to return to the display of the ownship symbol;

 - to set the ship symbol in the position of the cursor which appears when this mode is turned on;

 - to select chart display orientation (North Up/Head Up/Course Up);

 - to select ship symbol motion mode (True/Relative);

 - to increase the chart display scale by the fixed scale value;

 - to decrease the chart display scale by the fixed scale value;

 - to display the chart on the original scale;

 - to turn on Auto Zoom function;

 - to arrange Chart panels horizontally;

 - to arrange Chart panels vertically;

 - to turn on the Docking Mode;

 - to turn on the history of the Docking Mode.

User Interface Components

Panels

There is direct access to panels from the task. For ECDIS task, this is primarily the Control panel, which shows operational information and contains the most important task controls.

In ECDIS task, apart from the Control panel there are 14 functional panels, each designed for its special purpose within the ECDIS task:

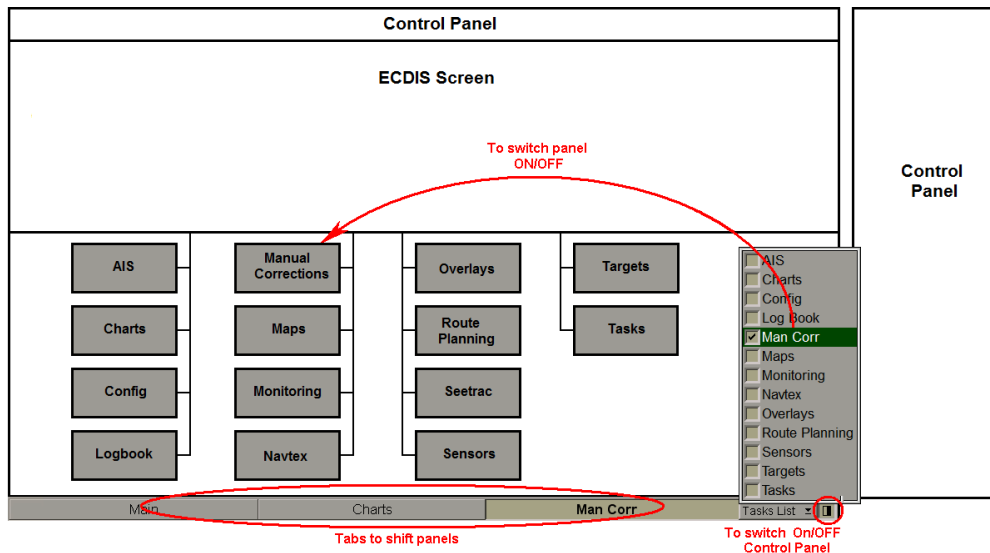

Panels (except the Control panel) are switched with tabs in the bottom part of the screen.

For the operator's convenience, the system implements a function for saving the current condition of **Main** chart panel when the functional panels are switched. This function's operation can be shown in a table:

Panel name	To open panel	To switch the open panel with the tab
Main	A	S
Dual	S	H
AIS	A	H
Charts	P	K
Config	P	P
Log Book	P	K
Man Corr	L	K
Maps	L	K
Monitoring	P	P

Panel name	To open panel	To switch the open panel with the tab
Navtex	L	K
Overlays	P	K
Route Planning	L*	K
Seetrac	L	H
Sensors	L	K
Targets	A	H
Tasks	L	K

where:

- A – the vessel is displayed on the ECDIS task screen, **Ahead**, **Autoload** and **Autoscale** functions performed automatically; orientation setting is North, motion setting is True;
- H – the display (chart boundaries) of the Chart panel is saved, along with the last orientation (North/Head/Course) and motion (True/Relative) settings which were made on this panel before;
- K – the display (chart boundaries) of the Chart panel which was set on this panel before it is saved; orientation setting is North, motion setting is True;
- L – the display (chart boundaries) of the Chart panel which was set in the previous active functional panel is saved; orientation setting is North, motion setting is True;
- L* – for **Route Planning** panels only: if a route has been selected, the focusing on the edited route is made automatically;
- S – the ship is displayed on the screen, **Ahead** function performed automatically; the last Chart panel orientation (North/Head/Course) and motion (True/Relative) settings are retained;
- P – the display (chart boundaries) of the Chart panel is saved, along with the last orientation (North/Head/Course) and motion (True/Relative) settings which were made on the previous active functional panel.

Pages

If functionality, which the panel is intended for, is rather extensive, for the convenience sake it is divided into pages. The purpose of pages corresponds to the individual tasks within the panel functionality. In the ECDIS task panels are divided into pages. They are switched by using tabs in the top part of the panel, which they belong to. Shown below is **Sensors** panel with pages intended for selection of essential information sensors: **Ship Position, Heading, Speed and Echosounder**:

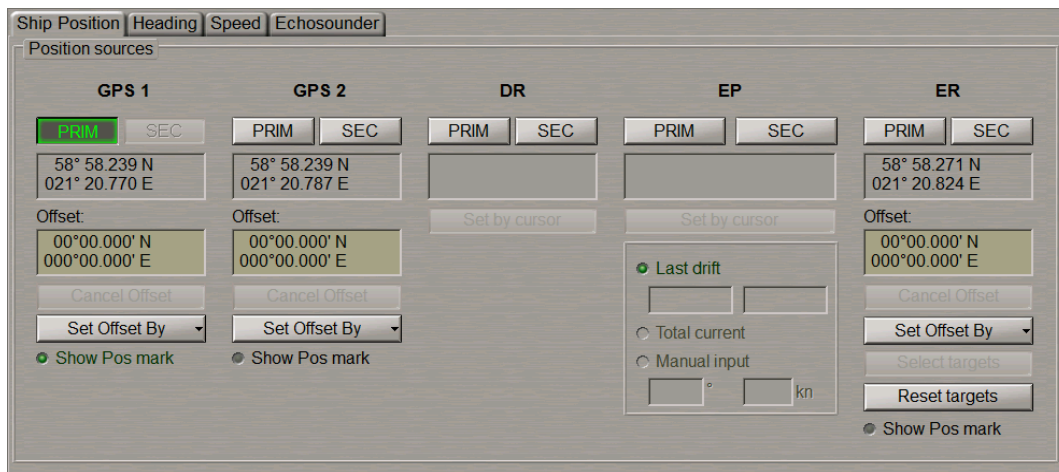

Control Panel Windows

The Control panel consists of windows. Each window serves for the display of some operational information, or contains the most frequently used task controls. Graphically, windows are divided with special lines. The sample below shows some Control panel windows of the main tasks.

HDG GYRO 2	216.5°	STW LOG 1	12.0 kn	COG GPS 1	216.5°	SOG GPS 1	12.0 kn
----------------------	---------------	---------------------	----------------	---------------------	---------------	---------------------	----------------

ECDIS Control panel has the **Multipanel** window, which allows setting different displays serving for accomplishment of operational tasks. Displays are selected from the drop-down list opened by pressing the button with the name of the currently set panel.

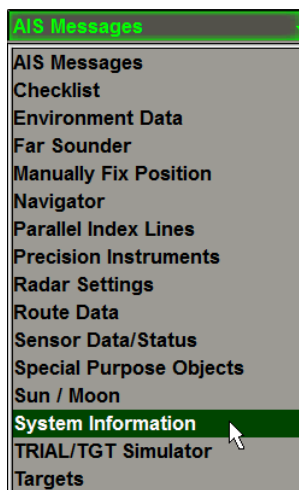

List Box Menu

The list box menus serve for selecting the necessary name or value from the list. The list box menus have a form with a button with an arrow. A press on the button opens up a menu which the selection is made from. The selected name or value is shown on the button after the menu is closed:

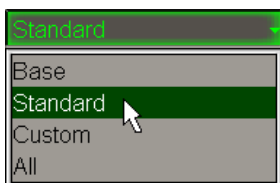

Text Boxes

Text boxes are used for entering values or names:

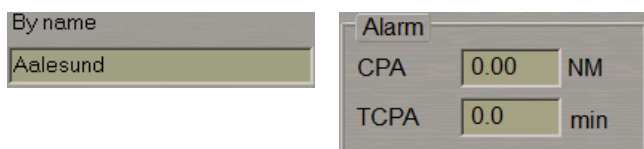

Input of names is made from ES6 keyboard. Values can be entered from the keyboard or by using the trackball. The trackball motion in the vertical direction produces fast change of a value in the text box, whereas the horizontal motion results in much slower change. In some text boxes, all you have to do after the input of the necessary value is press the left trackball button for the program to accept the entered value. In other text boxes, to exit from the input mode it will be necessary to press the right trackball button and confirm the entered value:

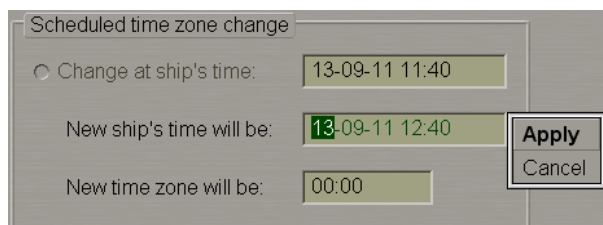

Buttons

Buttons are designed for activating some functions. If a button is greyed, the operation of the corresponding function is not available in the mode in question. Buttons may be of the following types:

	Button pressed	Button released	Button greyed
Push-to-lock buttons	 	 	
Buttons without locking			

If to be turned on, certain functionality needs input of a parameter value, which will be monitored, the button will be greyed until this parameter value is entered.

Parameter value is not entered	Parameter value is entered, the function is not switched on	Function is switched on
<input type="radio"/> Sounder depth <input type="text" value="0"/> m	<input type="radio"/> Sounder depth <input type="text" value="10"/> m	<input checked="" type="radio"/> Sounder depth <input type="text" value="10"/> m

Radio Buttons

These buttons serve for selecting one function only from the offered set:

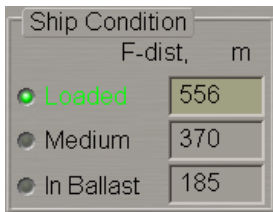

Indicators

Indicators show a level for the value set by using the buttons placed next to them:



Progress Bars

The progress bars show the degree to which the program has completed the operation run by the user:

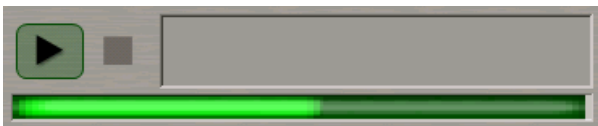

ECDIS Task Control Panel

The ECDIS task Control panel consists of a number of windows. Windows are displayed near the Chart panel. In addition, some the displayed windows can be moved (by dragging them with the cursor or by double clicking the left trackball button in the window area) onto the Chart panel. To return the window to its place, press  button. If the Control panel does not contain any windows, the area is filled with chart information. Control panel contains the **Display Panel** window, which is intended for the display of various data types. The window consists of nineteen displays:

- AIS Messages;
- Checklist;
- Environment Data;
- Ice charts;
- MOB (Man Over Board);
- Manually Fix Position;
- Monitoring and Advisor;
- Navigator;
- Parallel Index Lines;
- Precision Instruments;
- Radar Settings;
- Route Data;
- Sensor Data/Status;
- Special Purpose Objects;
- Sun / Moon;
- System Information;
- TRIAL/TGT Simulator;
- Targets;
- User Configurations (displayed only in the **Multipanel** window).

The displays are selected from the list opened by pressing the button with the name of one of displays in the top part of the window (except **MOB** and the **User Configurations** displays).

Button to the right of the **Display Panel** window  is intended for displaying additional the **Multipanel** window on the ECDIS task Chart panel. The system enables simultaneous independent operation with information displays selected in both windows.

COG/SOG/HDG/STW Window

HDG GYRO 1	270.0°	STW LOG 1	5.0 kn	COG GPS 1	270.0°	SOG GPS 1	5.0 kn
----------------------	---------------	---------------------	---------------	---------------------	---------------	---------------------	---------------

COG/SOG/HDG/STW window is designed for the display of ship motion parameters. The panel displays the following parameters:

- HDG – course from gyrocompass;
- STW – ship speed through the water.

Note: Only longitudinal part if DLOG selected.

- COG – ship course over the ground;
- SOG – ship speed over the ground.

Note: Calculated part (longitudinal and transversal) if DLOG selected.

The data source is specified to the right of the own ship motion parameter name:

- GYRO1 – gyrocompass with a digital input, its number specified;
- GPS1 – GPS (DGPS), its number specified;
- ER – echo reference mode;
- DR – dead reckoning mode;
- MAN – manual input;
- LOG1 – log (Speed Through Water) with a digital output, its number specified;
- DLOG1 – Doppler log, its number specified;
- NONE – no source available.

HDG GYRO 1	270.0°	STW LOG 1	5.0 kn	COG GPS 1	270.0°	SOG GPS 1	5.0 kn
----------------------	---------------	---------------------	---------------	---------------------	---------------	---------------------	---------------

VEGA

As a free cursor is positioned on the source name, the source alias entered in the System Configuration utility is displayed on the pop-up prompt window.

HDG GYRO 1	292.5°	STW DLOG 1	12.0 kn	COG GPS 1	292.2°	SOG GPS 1	12.0 kn
----------------------	---------------	----------------------	----------------	---------------------	---------------	---------------------	----------------

Gyro offset:+0.3°



If there is an offset to the gyro, the window displays corrected coordinates and a special symbol: the yellow triangle. As a free cursor is positioned on this triangle, the correction value is displayed on the pop-up prompt window.

For the data display principles, see document *Multi-Functional Display (v. 3.00.340). Functional Description, Chapter 2, section Navigational Sensors*, paragraph *Display of Navigational (Essential) Information*.

Alerts Window



The **Alerts** window is intended for displaying the alarms, warning and cautions. The window contains the following units:

-  - to open a list of generated alarms;
-  - to open a list of generated warnings;
-  - to open a list of generated cautions.

Below the example for cautions is given:



For more detailed description of the alerts display, see document *Multi-Functional Display (v. 3.00.340). Functional Description, Chapter 4, section Display of Alerts.*

Application Window

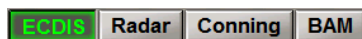

The **Applications** window is intended for loading/switching MFD applications:

- **ECDIS** – to turn on/switch to the ECDIS task;
- **Radar** – to turn on/switch to the RADAR task;
- **Conning** – to turn on/switch to the Conning task;
- **BAM** – to turn on/switch to the BAM Viewer.

Position Dropped Window



The window contains the following controls:

- **Position Dropped** – button with the message meaning that the ship symbol is not displayed on the chart. With a press on the button, the display of the ship symbols is restored. After the restoration of ship symbol display (also with the use of **Ahead** function), Transas logo appears in the place of a message.

Sensors Window



The **Sensors** window is intended for the display of information from different sources. The window contains the following controls:

- **X-1** – to select a scanner which the radar picture is supplied by;
- **Overlay** – to turn on display of radar overlay information on electronic chart in ECDIS;
- **AIS** – to turn on display of AIS targets;
- **ARPA** – to turn on display of information on targets processed by the ARPA and to select ARPA targets sources.

Vectors Window

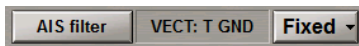

Vectors window is designed for the display the following parameters:

- **AIS filter** - to promptly open the **AIS** page of the **Targets** display on the Control panel. If the sleeping AIS targets filtering is enabled, or the display of some AIS target type it turned off (the filter is on this page), the button name is shown in yellow (see also document *Multi-Functional Display (v. 3.00.340). Functional Description, Chapter 4, section Indications, paragraph Display of Important Indications*);

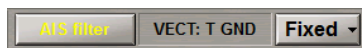

- **VECT: T GND** - indication showing the AIS targets vector mode and stabilization mode (see also document *Multi-Functional Display (v. 3.00.340). Functional Description, Chapter 4, section Indications, paragraph Display of Important Indications*);
- **Vectors** – to call a menu for setting the lengths of the own ship and target motion vectors; **Fixed** option allows a constant vector length to be set (in proportion to the screen size), the rest – by the set time value (in minutes, 1–24 min).

Network Window



The **Network** window is intended for display the station name and status in the network and, in the case of MASTER status, also the transfer of rights to other stations in the network. The window contains the following control:

- **(W01) MASTER** – to display the station name and status in the network.

Indications Window

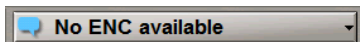

Indications window is designed for the display the indications.

As a new indication appears, the drop-down list button displays the  sign. Press the button for familiarizing yourself with all the indications.



For more detailed description of the indications display, see document *Multi-Functional Display (v. 3.00.340). Functional Description, Chapter 4, section Indications, paragraph Display of Indications.*

Time Window



The **Time** window is intended for the display of the current time. There may be two types of time values in the window: UTC and ship's time. To switch between them, press the button with a picture of the clock face (ship time if the button is pressed, UTC if it is released):

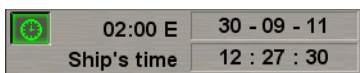

The window contains the following elements:

- **UTC/Ship's** – information on which time is currently displayed;
- **00:00 W/E** – time zone or the difference between the ship time and UTC (not displayed if UTC is selected); the format is hh:mm;
- **01-01-01** – display of the current date according to the selected time type; the format is dd-mm-yy;
- **00:00:00** – display of the current time; the format is hh:mm:ss.

Primary Window

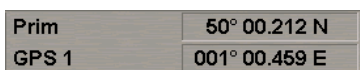

The **Primary** window is intended for the display of the primary positioning system and coordinates obtained from it. For the principles of displaying primary positioning data, see document *Multi-Functional Display (v. 3.00.340). Functional Description, Chapter 2, section Navigational Sensors, paragraph Display of Navigational (Essential) Information.*



The position source is specified in the left bottom part of the window. As a free cursor is positioned on the position source name, the source alias entered in the System Configuration utility is displayed on the pop-up prompt window.

Prim	50° 00.212 N
DGPS 1	001° 00.459 E

In case of GPS work in differential mode, the prefix “D” is added before its name.

Prim	60° 01.595 N
GPS 1	029° 16.496 E

Offset:
00° 00.396 S
000° 00.273 W

If there is an offset to the ship position coordinates, the window displays corrected coordinates and a special symbol: the yellow triangle. As a free cursor is positioned on this triangle, the correction value is displayed on the pop-up prompt window.

If RMC (IEC 61162 ed.4) message is available, MFD process it and display status of RAIM in the **Primary** window. The color of value of coordinates shows the quality of position state:

- Black – safe;
- Orange – caution;
- Orange – unsafe (this event is recorder to the Log Book).

Safe	Caution	Unsafe												
<table border="1"> <tr> <td>Prim</td> <td>27° 22.505 N</td> </tr> <tr> <td>DGPS 1</td> <td>152° 00.045 E</td> </tr> </table> <p>Position state - safe</p>	Prim	27° 22.505 N	DGPS 1	152° 00.045 E	<table border="1"> <tr> <td>Prim</td> <td>27° 22.505 N</td> </tr> <tr> <td>DGPS 1</td> <td>152° 00.045 E</td> </tr> </table> <p>Position state - caution</p>	Prim	27° 22.505 N	DGPS 1	152° 00.045 E	<table border="1"> <tr> <td>Prim</td> <td>27° 22.505 N</td> </tr> <tr> <td>DGPS 1</td> <td>152° 00.045 E</td> </tr> </table> <p>Position state - unsafe</p>	Prim	27° 22.505 N	DGPS 1	152° 00.045 E
Prim	27° 22.505 N													
DGPS 1	152° 00.045 E													
Prim	27° 22.505 N													
DGPS 1	152° 00.045 E													
Prim	27° 22.505 N													
DGPS 1	152° 00.045 E													

Secondary Window

Sec:GPS 2	167.5° - 9 m
-----------	--------------

The **Secondary** window is intended for the display of the secondary positioning system, and of the bearing and range to the position obtained for the Primary positioning system. For the principles of displaying secondary positioning system data, see document *Multi-Functional Display (v. 3.00.340). Functional Description, Chapter 2, section Navigational Sensors, paragraph Display of Navigational (Essential) Information.*

Sec:GPS 2	90.0° - 178 m
-----------	---------------

TRIMBLE

The position source is specified in the left part of the window. As a free cursor is positioned on the position source name, the source alias entered in the System Configuration utility is displayed on the pop-up prompt window.

Sec:DGPS 2	167.5° - 9 m
------------	--------------

In case of GPS work in differential mode, the prefix “D” is added before its name.

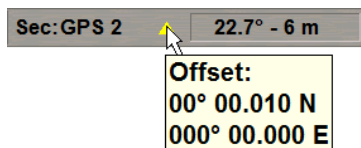

If there is an offset to the ship position coordinates, the window displays corrected coordinates and a special symbol: the yellow triangle. As a free cursor is positioned on this triangle, the correction value is displayed on the pop-up prompt window.

Charts Area Window



The **Charts Area** window is designed for the adjustment of the chart display on the chart panel:

- **Chart number** – to call a menu with a list of charts under the ship position (if the ship symbol is displayed on the chart) or the list of all the charts available in the ship folio; shown on the button is the current chart number;
- **Autoload** – to turn on the function for the automatic loading of charts, there is an indicator to the right of the button:
 - **ON** – the function is turned on (**Autoload** button is greyed);
 - **OFF** – the function is turned off;
 - **FIX** – to fix the current chart.
- **Last upd.** – date of the most recent chart updating in dd-mm-yyyy format;
- **Updated to** – the media, which was used for the latest updating of TX-97 or SENC chart collection.

Display Panel Window

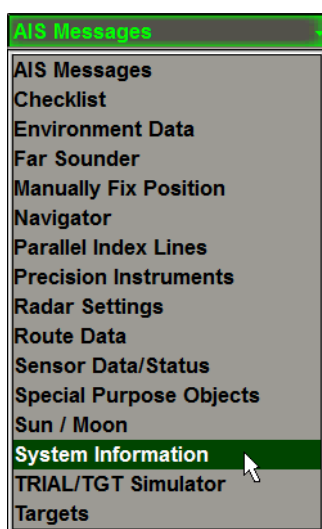

The **Display Panel** window is intended for the display of various data types.

The window consists of displays which are selected from the list opened by pressing the button with the name of one of the displays in the top part of the window.

Button  to the right of the **Display Panel** window is intended for displaying additional the **Multipanel** window on the ECDIS task Chart panel. The system enables simultaneous independent operation with information displays selected in both windows.

Operational Window

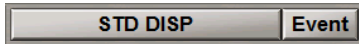

The window contains the following functional buttons:

- **STD DISP** – to turn on the display of objects included in the standard display;
- **Event** – to make a manual entry of data in the electronic ship logbook for the current moment, and to place a special mark on the ownship track.

EBL/VRM/CHL Window



The **EBL-VRM1** and **EBL-VRM2** pages of the window is intended for turning on and adjusting two independent electronic measurement tools. The window contains the following units:

- **EBL 1(2)** – to turn on EBL 1(2) true or relative;
- **VRM 1(2)** – to turn on VRM 1(2);
- **OFF SET** – to turn on the shift of EBL/VRM 1(2) reference point;
- **Fixed** – to fix EBL/VRM 1(2) reference point relative to the ground (operates in the OFFSET mode only).

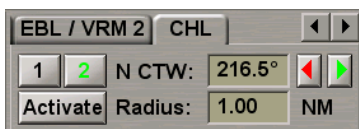

The **CHL** page of the window duplicates functionality from the **CHL** page of the **Precision Instruments** display of **Display Panel** window (see document *Multi-Functional Display (v. 3.00.340). Additional Functions, Chapter 1*, section *Precision Instruments*, paragraph *Using the Curved Heading Line*). All the buttons and fields are synchronised. The page contains the following parameters:

- **1** – to turn on the display of the 1 Curved Heading Line on the ECDIS task screen;
- **2** – to turn on the display of the 2 Curved Heading Line on the ECDIS task screen;
- **Active 1/2** – to switch between the Carry and Drop modes for 1/2 Curved Heading Lines;
- **N CTW** – ship course after the turn and buttons for its setting;
- **Radius** – ship turn radius.

Information Window

Depth in Metres WGS-84

This window includes:

- **Depth in Metres** – information on the depth measurement units used in the ECDIS task;
- **WGS-84** – to warn that the ECDIS uses charts based on WGS-84 datum.

Abbreviations Used in the User Interface

ECDIS task use the following abbreviations:

Abbreviation	Full Name	Abbreviation	Full Name
AIS	Automatic Identification System	HDG	Heading
ARPA	Automatic Radar Plotting Aid	LOG (DLOG)	Log (Doppler Log)
BRG	Bearing	LOP	Line Of Position
BWOL	Bearing to Wheel over Line	N Up	North Up
BWW	Bearing waypoint to waypoin	PS	Positioning System
C Up	Course Up	PTA	Planning Time of Arrival
COG	Course Over Ground	RAD	Radius
CPA	Closest Point of Approach	R	Range LOP's
CRS	Route leg course	RM	Relative Motion
DIST	Distance	RNG	Range
DR	Dead Reckoning	ROT	Rate Of Turn
DWOL	Distance to Wheel over Line	SOG	Speed Over Ground
ENC	Electronic Navigational Chart	Stand	Standard
ETA	Estimated Time of Arrival	STG	Speed To Go
EBL	Electronic Bearing Line	STW	Speed Through the Water
EP	Estimated Position	TCPA	Time to Closest Point of Approach
ER	Echo Reference	TM	True Motion
ECHO	Echosounder	TTG	Time To Go

Abbreviation	Full Name	Abbreviation	Full Name
GLO (DGLO)	Global Orbiting Navigation Satellite System (Differential Global Orbiting Navigation Satellite System)	V	Visual Bearing LOP's
GLONASS (DGLONASS)	Global Orbiting Navigation Satellite System (Differential Global Orbiting Navigation Satellite System)	VR	Visual/Range LOP's
GPS (DGPS)	Global Positioning System (Differential Global Positioning System)	VRM	Variable Range Marker
GYRO	Gyrocompass	WPT	Way Point
GZ	Guard Zone	XTD	Cross Track Distance
H Up	Head Up		

Use of Uniform Measurement Units

In the ECDIS task, measurement units are set by default and can be changed by the operator on **Units** page of **Config** panel (see *Chapter 3*, section *Setting of Measurement Units*). The following units and their shortened names are used:

Physical Value	Measurement Unit	Abbreviation
Ship and target speed	Knot	kn
	Kilometre per hour	km/h
Distances	Nautical mile	NM
	Kilometre	km
	Statute mile	stm
	Hectometre	hm
Precision Distances	Metre	m
	Feet	ft
	Yard	yard
Depth/Height	Metre	m
	Feet	ft
	Fathom	fm

Physical Value	Measurement Unit	Abbreviation
Draught	Metre	m
	Feet	ft
Wind speed	Metre per second	m/s
	Knot	kn
	Kilometre per hour	km/h
Temperature	Degree Celsius	°C
	Degree Fahrenheit	°F

The ECDIS task uses geographic coordinates calculated on the basis of WGS 84 datum only.



























Keyboard









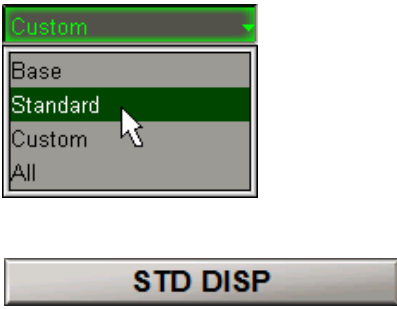

The ECDIS task ES6 keyboard is intended for the information input and task control.

The ECDIS task ES6 keyboard is presented below:



Provided below is a table which specifies the ECDIS tasks and ES6 keyboard corresponding controls.

Function	Keyboard ES6	ECDIS GUI
Ownship motion modes		
Zoom In		
Zoom Out		
Ahead		
Event		
Overlay		
Targets		 
MOB		
Ownship presentation modes		
EBL		
VRM		
Gain		
Sea		

Function	Keyboard ES6	ECDIS GUI
Rain		
Standard Display		
Show All Layers		
Alarm		
Palette		
Opening of Transas Integrator toolbar		

Virtual Keyboard

Where a trackball only is available in the MFD configuration, the use of a virtual keyboard is provided for.



To display the virtual keyboard, press the  button in the Chart panel toolbar.

The button is not shown in the toolbar of the Chart panel unless it was activated in the System Configuration utility during the installation (see document *Multi-Functional Display (v. 3.00.340). Installation Guide Part I, Chapter 2, section MFD Configuration, paragraph Workstation Settings*).



The virtual keyboard is shown in the bottom part of the Control panel and can be moved within it. To do this, position the free cursor on the virtual keyboard as shown below, and press the left trackball button. Holding the left trackball button, move the virtual keyboard to the necessary place so that it does not obscure the necessary input box.

There are two ways to close the virtual keyboard:

- Press the button  in the top right corner of the virtual keyboard;
- Release the button  in the Chart panel toolbar.

Chapter 2.

ECDIS Task Turning On/Off

This chapter describes the procedure used for starting/exiting from the MFD.

<u>Turning the ECDIS Task On</u>	46
<u>Turning the ECDIS Task Off</u>	47

Turning the ECDIS Task On

Each WS is started by pressing **On/Off** button on its console.



The **Transas Integrator** window will be loaded.



Tasks can be equally well switched and started in following ways:

1. From the ES6 keyboard. To turn on the ECDIS task, press <ECDIS> key on ES6 keyboard.
2. From Control panel. All the tasks use identical task-switching user interface implemented as buttons with task names.

<p>ECDIS</p>	<p>RADAR</p>
<p>ECDIS Radar Conning BAM</p>	<p>ECDIS Radar Conning BAM</p>
<p>CONNING</p>	<p>BAM</p>
<p>ECDIS Radar Conning BAM</p>	<p>ECDIS Radar Conning BAM</p>

- From the Transas Integrator. To turn on the ECDIS task from the Transas Integrator utility, press **ECDIS** button  .

The following window will be displayed on WS upon start of ECDIS task loading.

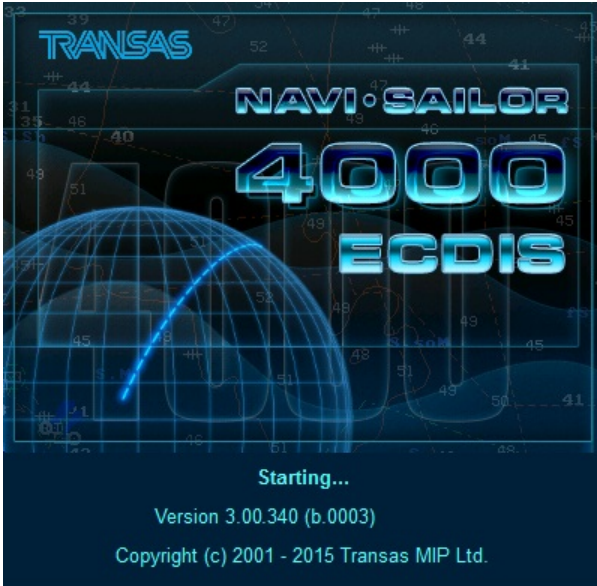

After the program loading, the ECDIS task screen will be displayed.

Turning the ECDIS Task Off

Open **Config** panel by selecting the appropriate line of **Tasks List** menu in the tabs zone of the ECDIS task screen.

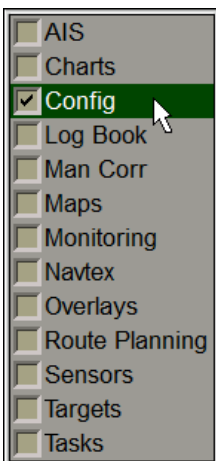

Use the tab in the top part of **Config** panel, which will open up, to switch to **General** page.

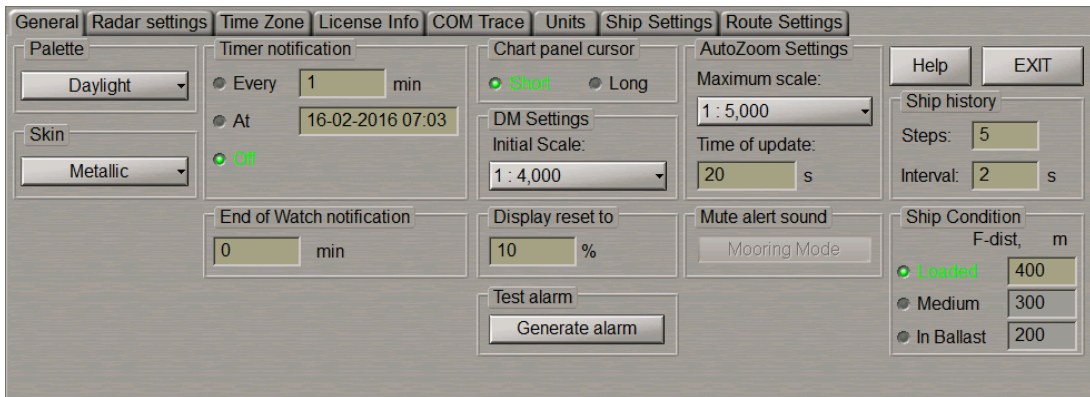

Press **Exit** button in the right-hand part of the panel: confirmation window will appear.

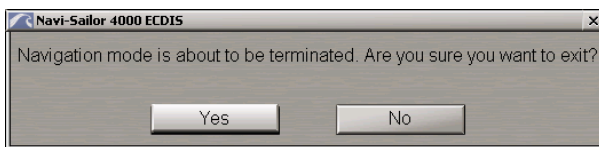

Press **Yes** button to confirm exit from the program.

The program will be closed.

Chapter 3.

ECDIS Task Control

This chapter describes the general procedure used in the operation of the ECDIS task.

<u>Transfer of Rights</u>	50
<u>Turning On/Off Control and Conning Panels Display on the ECDIS Task Screen</u>	50
<u>Setting Control Panel Windows Display</u>	52
<u>Setting of Measurement Units</u>	53
<u>ECDIS Task Screen Configuration</u>	54
Setting of Screen Colour Palette	54
Setting of Screen Graphic Presentation	55
Switching the Graphic Cursor Type	56
Setting of Screen Boundaries Re-Draw as the Ship Symbol Approaches Them	56
<u>Chart Panel Settings</u>	56
Setting of Main and Dual Panel Displays	56
Setting of Ship Symbol on the Chart Panel by the Cursor Position	58
Setting Chart Panel Orientation	59
Setting Ship Symbol Motion Modes	59
Setting Ship Display and Its Motion Parameters on the ECDIS Task Screen	60
Setting of the Lengths of the Own Ship and Targets Vectors	61
<u>Setting Time Zone</u>	61
Setting Current Time Zone	62
Setting Time Zone Change	62
<u>Use of ECDIS Task Tools</u>	63
Return of Own Ship Symbol Display to the ECDIS Task Screen	63
Viewing Charts	63
ERBL	64
Zoom	65
Using Touchscreen Functions	66
EBL/VRM	70
Index Lines	70
Quick Distance Tool	72
Manual Entry in the Ship Log	73

Transfer of Rights

On ECDIS task with MASTER status in the **Network** window of the Control panel, press **MASTER** button and select **Change MASTER** station line from drop-down list.



Press the **Yes** button in the window which will appear to confirm the transfer of rights to another WS.

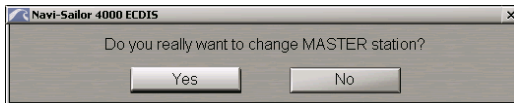

On ECDIS task with SLAVE status, press **Take Over Control** button in the **Network** window of the Control panel.



As this button is pressed on one of WS's, all the rights are transferred to this station. The former station with MASTER status will have SLAVE status. If **Take Over Control** button was not pressed on any of the stations during the transfer of rights, all the rights remain with the station, which the transfer of rights was initiated from (see document *Multi-Functional Display (v. 3.00.340). Functional Description, Chapter 10, section ECDIS Master and Slave*).

Turning On/Off Control and Conning Panels Display on the ECDIS Task Screen

To turn off the Control panel display on the ECDIS task screen, press the button  in the right part of the tabs zone.

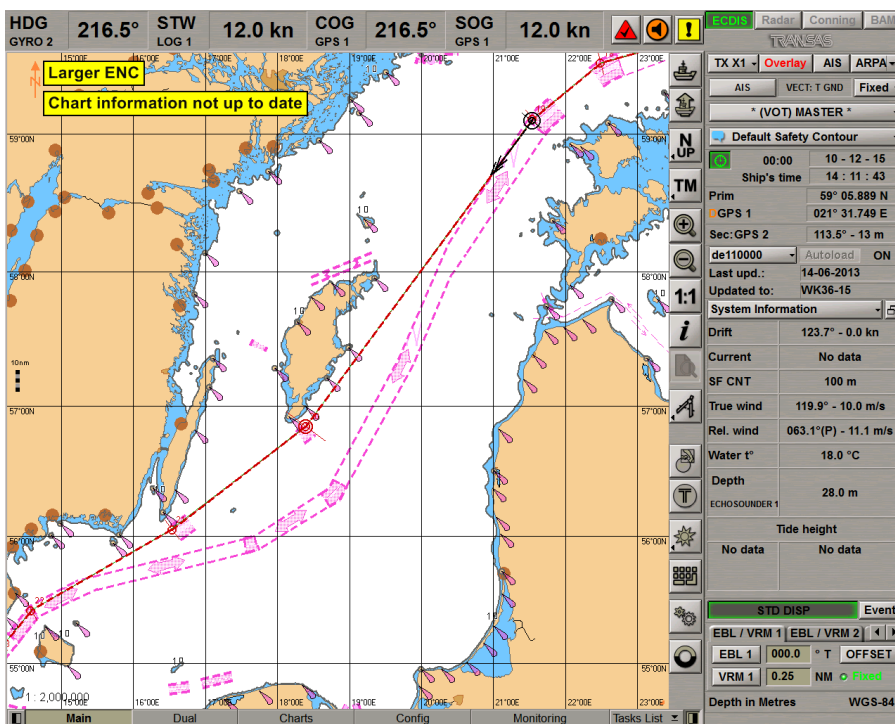

To re-display the Control panel, press the button  in the right part of the tabs zone of the ECDIS task screen.

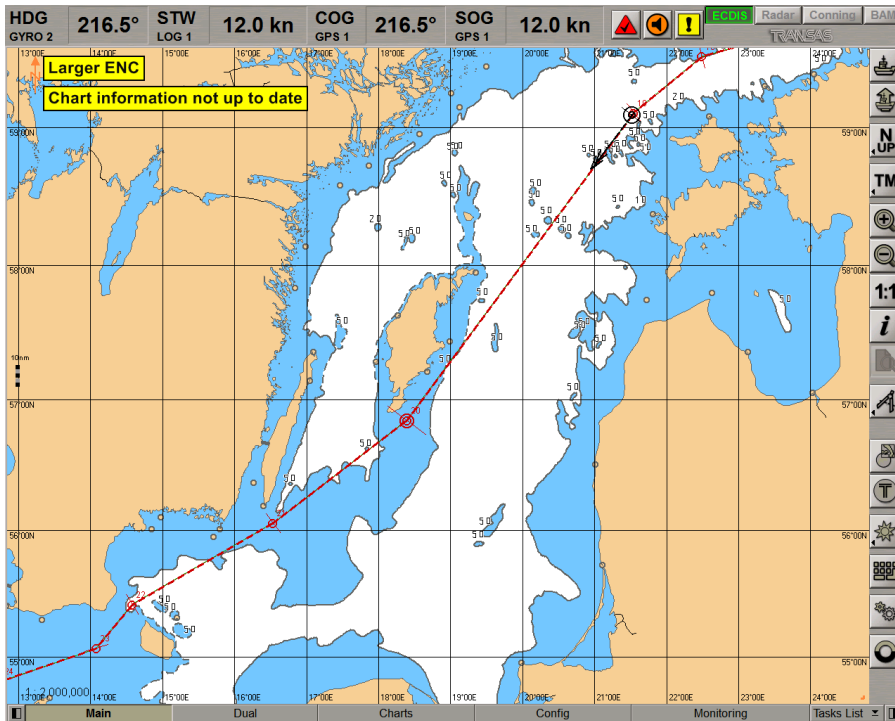

To turn on the Conning panel display on the ECDIS task screen, press the  button in the left part of the tabs zone.

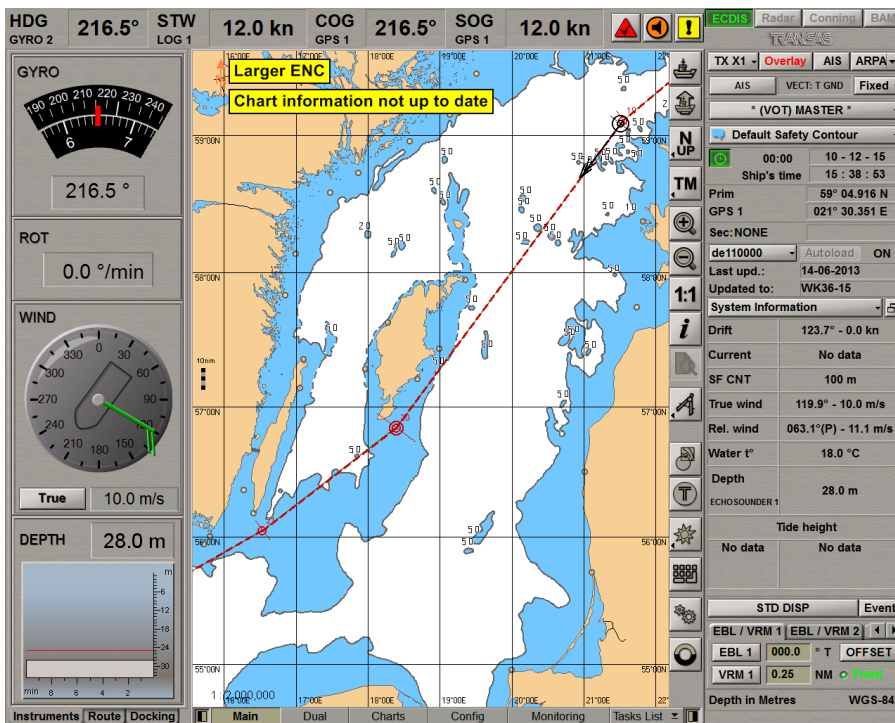

The Conning Panel contains three Screen Views (see also document *Multi-Functional Display (v. 3.00.340). Additional Functions, Chapter 4, , section Conning Task Structure*), which are formed according to their functional purpose from the viewpoint of navigation:

- Instruments;
- Route;
- Docking.

To turn off the Conning panel press the  button in the left part of the tabs zone of the ECDIS task screen.

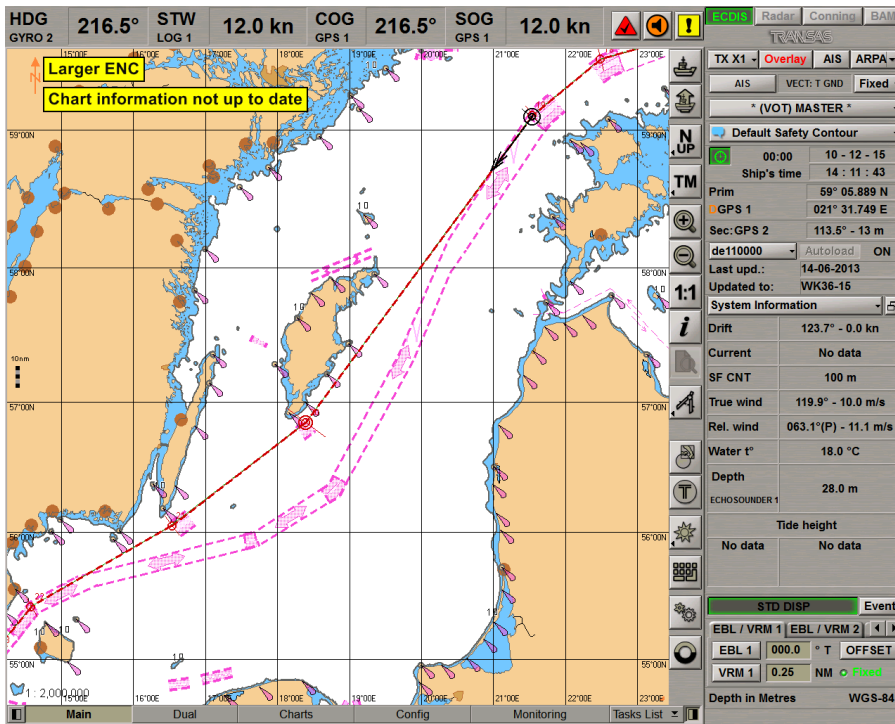

Setting Control Panel Windows Display

Set the order of the panel windows display by “dragging” them as required to the Chart panel.

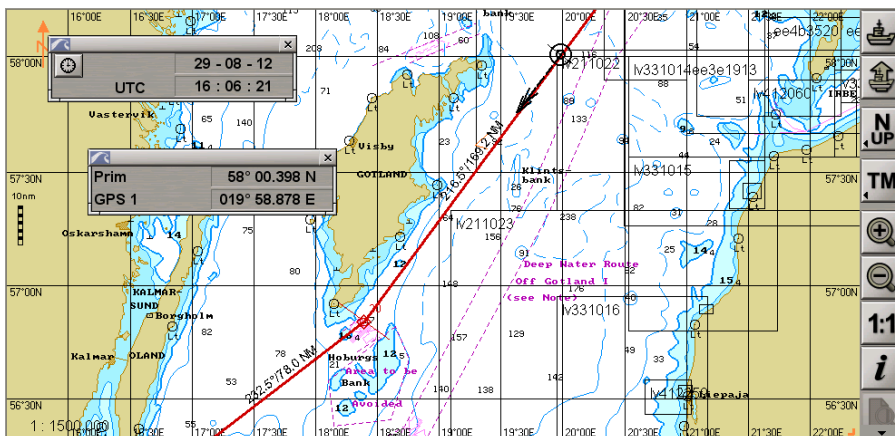

To return windows to the Control panel, press  button in the top right corner of each window.

Setting of Measurement Units

Open **Config** panel by selecting the appropriate line of **Tasks List** menu in the tabs zone of the ECDIS task screen.

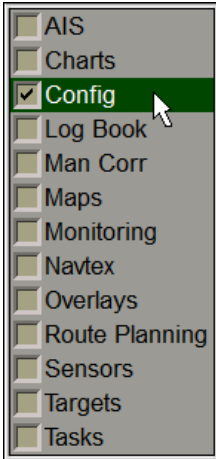

Use the tab in the top part of **Config** panel, which will open up, to switch to **Units** page:

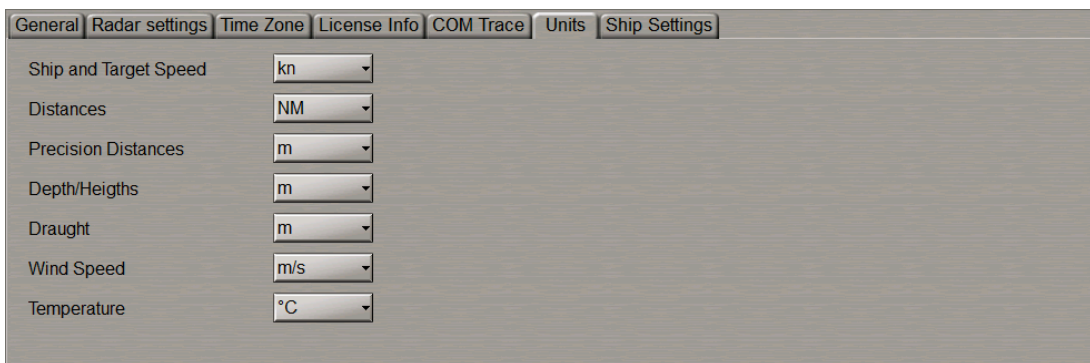

Press the button opposite to the name of physical value.

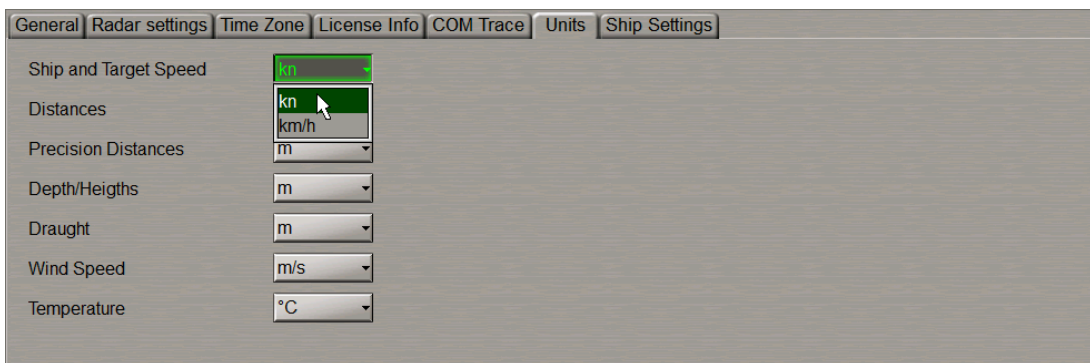

From the drop-down list, select the necessary of measurement units.

Create a necessary configuration for all measurement units (the list of available units see in *Chapter 1*, section *Use of Uniform Measurement Units*).

ECDIS Task Screen Configuration

Open **Config** panel by selecting the appropriate line of **Tasks List** menu in the tabs zone of the ECDIS task screen.

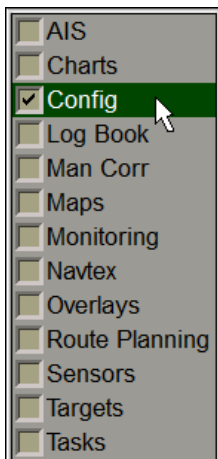

Use the tab in the top part of **Config** panel, which will open up, to switch to **General** page:

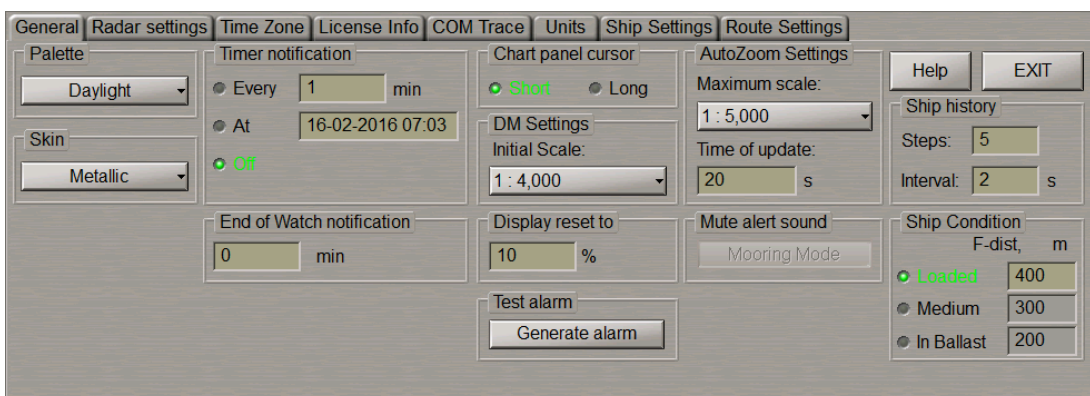

Setting of Screen Colour Palette

Palette group is designed for selecting the screen colour palette to suit the outside illumination:

- Daylight;
- Dusk – night with moon;
- Night – moonless night;
- Night inverted – moonless night (Control panel text inverse colour).

For S-57 format charts, three palettes are used: Daylight (**Daylight**), Dusk (**Dusk**) and Night (**Night** and **Night inverted**).

In **Palette** group, press the button with the name of the set screen colour palette.



In the list, which will open up, select the necessary menu line to set screen colour palette.



Attention! Use of the brightness control may inhibit visibility of information at night.

There is another way to switch the palettes. Press successively the <DAY/NT> on ES6 keyboard. Palettes will be switched in the order of their arrangement in the **Palette** group of **General** page.

Setting of Screen Graphic Presentation

Skin group is designed for selecting the screen graphic presentation:

- No skin;
- Black;
- Carbon;
- Elastic;
- Metallic;
- Plastic.

In **Skin** group, press the button with the name of the set screen graphic presentation.

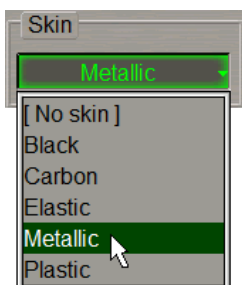

Switching the Graphic Cursor Type

The graphics cursor is used during the operation of some of ECDIS task functions and represents an intersection of lines corresponding to the latitude and longitude of the given point, but the form of the graphics cursor can be changed as required. **Chart panel cursor** group serves for setting the following types of the graphics cursor:

- Short – the cursor is shown in the form of a small cross;
- Long – the cursor is shown in the form of an intersection of two lines across the entire Chart panel.



In **Chart panel cursor** group, check the appropriate checkbox to select the graphic cursor type.

Setting of Screen Boundaries Re-Draw as the Ship Symbol Approaches Them

Display Reset to group is used for setting the calculated screen redraw boundaries – percentage ratio of the screen length and distance from the ship symbol to the screen boundary (10–90 per cent).

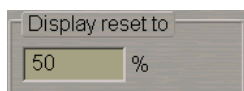

Use the input window in **Display reset to** group to set the ratio (in per cent) between the screen length and distance from the ship symbol to the screen boundary.

As the ship symbol approaches the screen boundary so that the set ratio is fulfilled, the screen will be re-drawn.

Chart Panel Settings

Setting of Main and Dual Panel Displays

To enable the display of electronic charts and associated information, **Main** and **Dual** panels are used.

You can change vertical dimensions of **Main** and **Dual** chart panels by using the cursor. As the cursor is positioned on the bottom boundary of the **Main** panel, it will change its form, then get hold of the boundary and set it at the desired height. If the two Chart panels are arranged vertically, this functionality is retained for altering horizontal dimensions (this arrangement is possible for Chart panels only).

Use the tab in the lower part of ECDIS task screen to switch to **Dual** panel.

This panel is an additional Chart panel where the ship symbol is permanently displayed. The panel is not displayed if any of functional panels are turned on (activated), and vice versa: when it is displayed, no functional panels can be seen.

The Chart Area of **Main** and **Dual** panels is designed for the following purposes:

- to display electronic charts showing classes of chart information (determined on **Charts** panel);
- to display the ownship symbol with motion vectors;
- to display the route loaded for proceeding by in the Navigation mode;
- to display the targets and AIS objects.

Displayed in the top left corner of the Chart area is the panel orientation symbol:  an arrow showing direction to the north.

The bottom right corner of the electronic chart displays an angle shaped indicator .

The line is a graphic presentation of the maximum possible error of plotting objects on the chart. When a chart is displayed on the scale of the original, the linear size of the error is taken to be 2 mm. As the scale is growing, the linear dimensions of the indicator increase showing to which extent the chart information can be relied on.

By default, **Main** and **Dual** panels are displayed vertically, that corresponds to pressed  button in **Dual** panel.

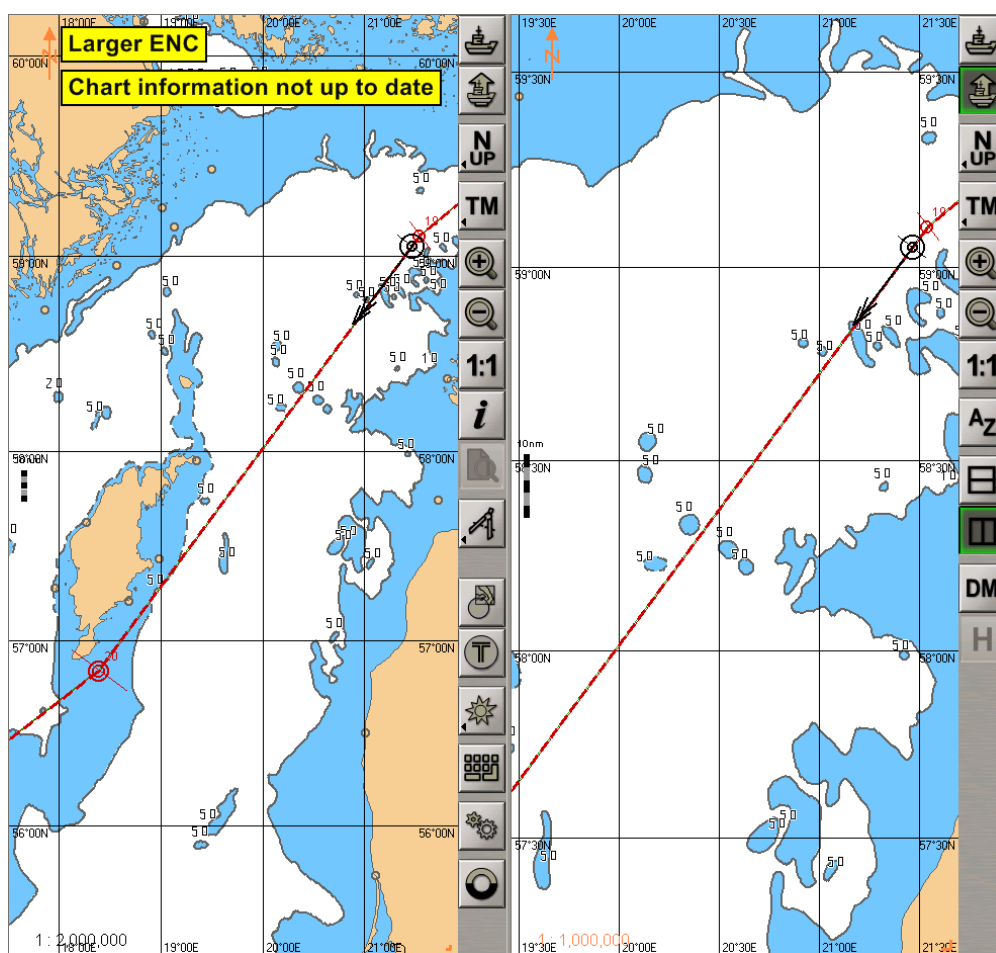

To change the order in which the Chart panels are displayed, press  button in the **Dual** panel.

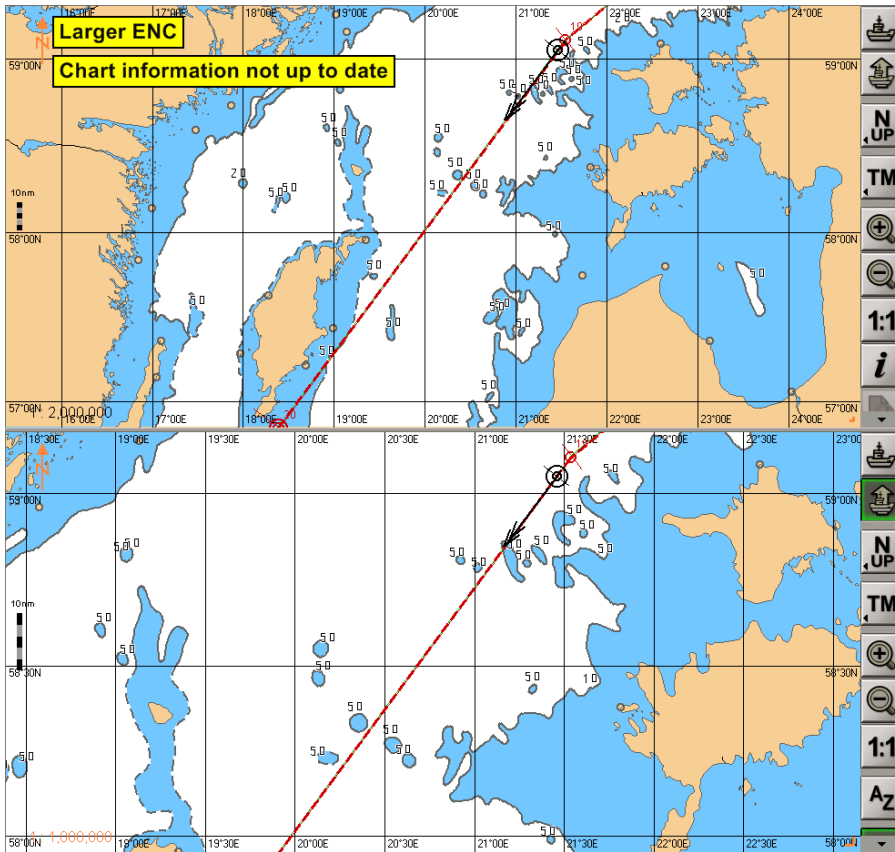

The display of panels will change.

Setting of Ship Symbol on the Chart Panel by the Cursor Position

To set the ship symbol in the relative motion mode in any point of the Chart panel, press  button. Position the graphic cursor, which will appear, in the place within the Chart panel convenient for the ship symbol display.

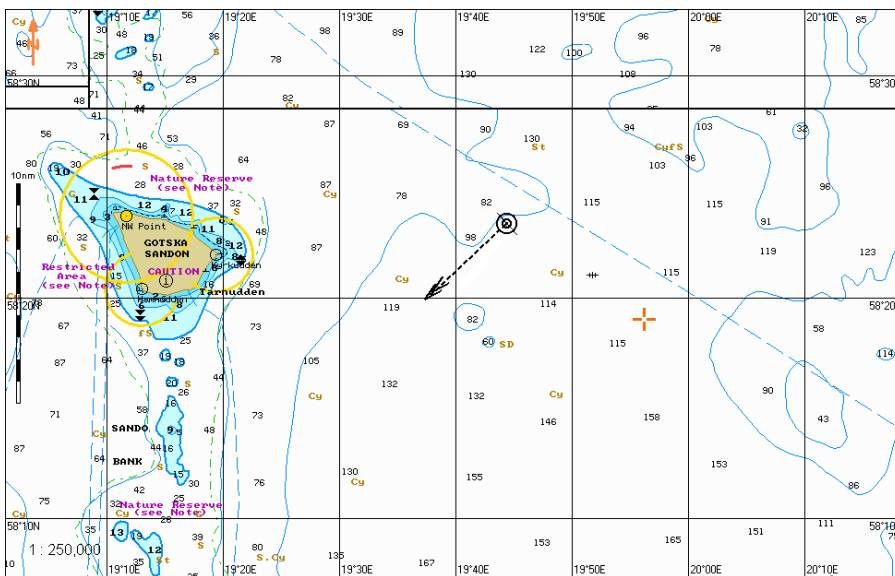

Press the left trackball button. The Chart panel will be re-drawn so that the ship symbol is in the place indicated with the cursor.

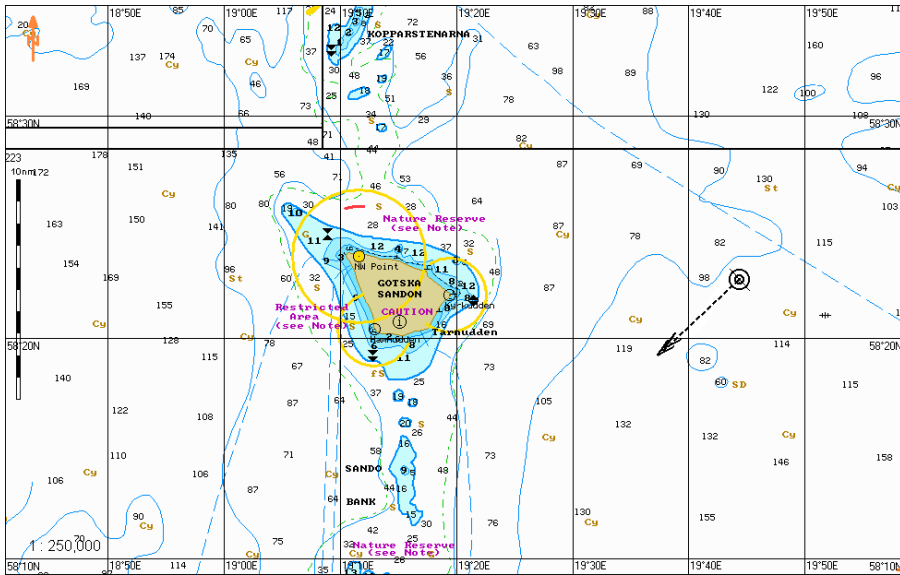

Setting Chart Panel Orientation

Set the Chart panel orientation by pressing the button in Chart panel toolbar :



- for the orientation to the north



- for the orientation by the compass heading;



- for the orientation by the direction of the current leg of the monitored route.

There is another way of setting the Chart panel orientation. Press successively the <N/H/C UP> key on the ES6 keyboard. The Chart panel orientation will be switched in the specified order.

Setting Ship Symbol Motion Modes

To select the ship symbol motion mode, press the button in the toolbar of the Chart panel:



- to select relative motion mode;



- to select true motion mode.

There is another way to select the ship symbol motion mode. Press successively the <TM/RM> key on ES6 keyboard. The ship symbol motion mode will be changed to the reverse.

Setting Ship Display and Its Motion Parameters on the ECDIS Task Screen

Open **Monitoring** panel by selecting the appropriate line of **Tasks List** menu in the tabs zone of the ECDIS task screen.

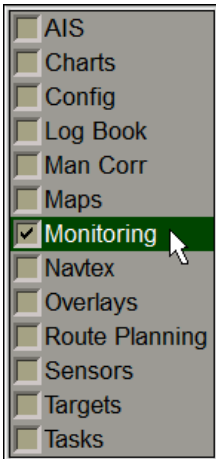

Use the tab in the top part of **Monitoring** panel, which will open up, to switch to **Route Monitoring** page:

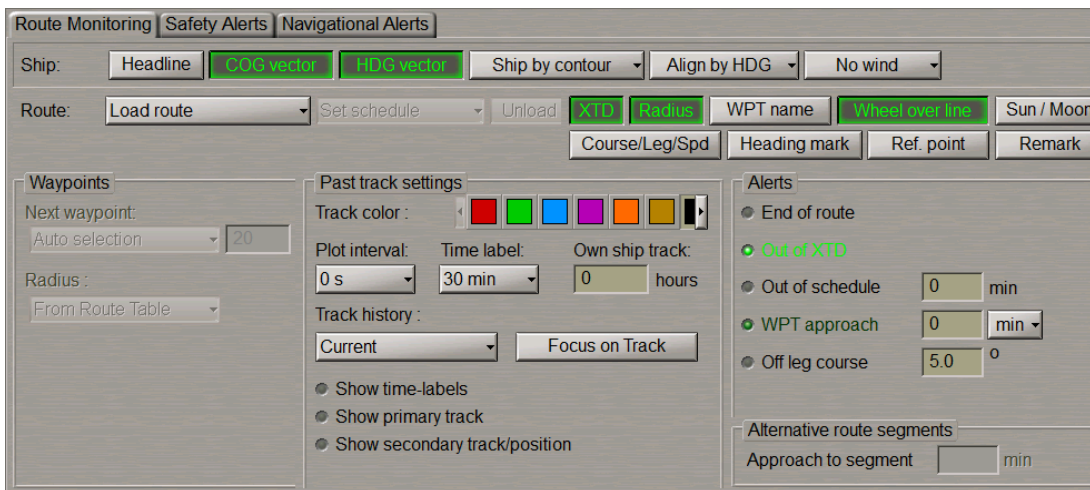

To turn on/off the display of own ship and its motion parameters, press the following buttons in the **Ship** group:

- **Head line** – to display own ship compass course line;
- **COG vector** – to display motion vector (over the ground);
- **HDG vector** – to display vector of motion relative to the water (log speed and compass course).



Select from the drop-down lists the following settings:

- **Ship by ...** – to display of the own ship (see document *Multi-Functional Display (v. 3.00.340). Functional Description, Chapter 3*, section *Ship Motion Data*, paragraph *Ship Symbol on the Electronic Charts*) on the Chart panel as:
 - **symbol** – the ship symbol (regardless of the scale);
 - **contour** – the ship contour (when the current screen scale is commensurate with the ship dimensions).
- **Align by ...** – to switching orientation (see document *Multi-Functional Display (v. 3.00.340). Functional Description, Chapter 3*, section *Ship Motion Data*, paragraph *Own Ship Motion Vectors*) of the own ship symbol display along:
 - **HDG** – the vector of the ship’s motion as per the course detector (gyro) reading;
 - **COG** – the ship’s true motion (COG) vector.
- **Wind vector** – to select true wind vector display mode (see document *Multi-Functional Display (v. 3.00.340). Functional Description, Chapter 2*, section *Other Sensors*, paragraph *Wind Interface*).

Setting of the Lengths of the Own Ship and Targets Vectors

Press vectors button in the **Vectors** window on the Control panel (the button shows current vector length).

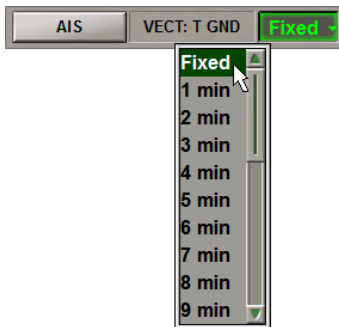

Select the required vector length (see document *Multi-Functional Display (v. 3.00.340). Functional Description, Chapter 3*, section *Own Ship Motion Data*, paragraph *Own Ship Motion Vectors*) from the list, which will open up and press the left trackball button.

Setting Time Zone

Open **Config** panel by selecting the appropriate line of **Tasks List** menu in the tabs zone of the ECDIS task screen.

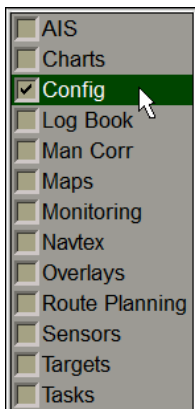

Use the tab in the top part of **Config** panel, which will open up, to switch to **Time Zone** page.

Setting Current Time Zone

Current time zone settings group contains the following elements:

- **UTC time** – line for the display of the current UTC time;
- **Ship's time** – line for the display of the current ship time;
- **Time zone** – line for the display of the time zone (difference between the current ship and UTC time).

Use **Time zone** line to enter the ship's time zone (from 14E to 12W). Press <Enter> key: the time zone value will be set, whereas the ship time value in **Ship's time** line will change to suit the entered time zone.

As the ship time is entered in **Ship's time** line, the time zone will change in **Time zone** line.

Setting Time Zone Change

Schedule time zone change group contains the checkbox for enabling (checkbox checked) the change of time zone function and a line for change settings:

- **Change at ship's time** – line for the input and display of the ship time when the time zone is required to be changed (clock put forward/back);
- **New ship's time will be** – line for the input and display of the new ship time;
- **New time zone will be** – line for the input and display of the new time zone.



Use **New time zone** will be line of **Schedule time zone change** group to set the new time zone value. Press <Enter> key. Use **Change at ship time** line to set the ship time value when the time zone is expected to change.

Press <Enter> key. Check the activated **Change at ship time** checkbox. At the set time, the time zone will be changed to suit the value entered for it.

Use of ECDIS Task Tools

Return of Own Ship Symbol Display to the ECDIS Task Screen

There are three ways to return the own ship symbol display to the ECDIS task screen:

1. Press Ahead  button on the Chart panel toolbar.
2. Press <AHEAD> key on the ES6 keyboard.
3. Press the STD DISP  button in the **Operational** window of the Control panel.

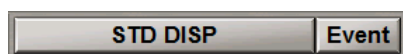



The own ship symbol will appear on the ECDIS task screen: the screen is re-drawn so that the ship symbol moves in the direction opposite to the current course.



Attention! In true motion mode, even if the ship symbol is available on the ECDIS task screen, the screen is re-drawn relative to the ship symbol.

Viewing Charts

Standard View cursor  (see document *Multi-Functional Display (v. 3.00.340). Functional Description, Chapter 3, section ECDIS Task Cursors*, paragraph *Free Cursor*) appears on the Chart panel by pressing the right trackball button.

As the left trackball button is pressed, **Review** function is turned on, whilst the cursor acquires the form of a graphics cursor .

By moving the cursor with the trackball, view the necessary charts beyond the ECDIS task screen boundary. At this stage, *Autoload* function is required to be ON (see document *Multi-Functional Display (v. 3.00.340). Functional Description, Chapter 1, section Chart Control, paragraph Autoload*).

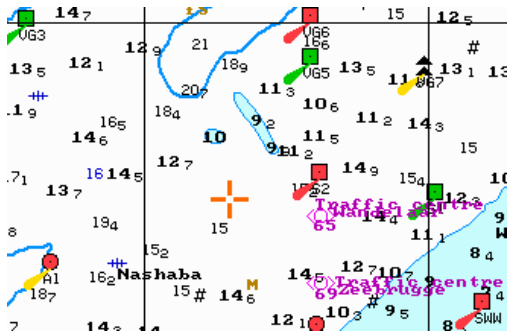

The graphic cursor coordinates are displayed in Review information window in the bottom part of the Control panel.

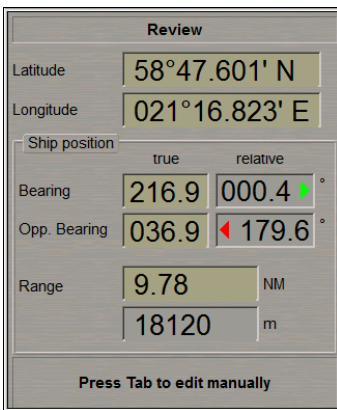

ERBL

Standard ERBL cursor  (see document *Multi-Functional Display (v. 3.00.340). Functional Description, Chapter 3, section ECDIS Task Cursors, paragraph Free Cursor*) appears on the Chart panel by pressing the right trackball button.

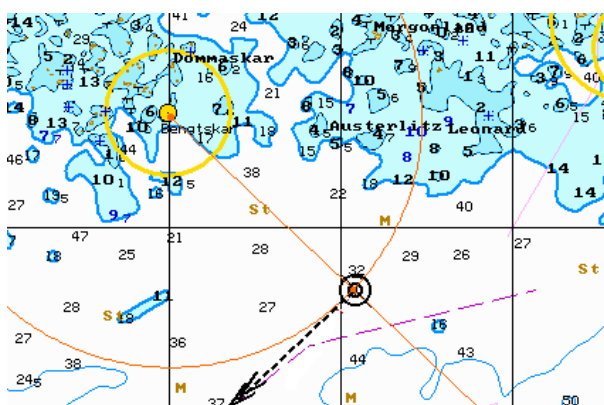

Coordinates from the ERBL (bearing and range to the selected point) are displayed in the information window in the bottom part of the panel.

ERBL	
Latitude 1	59°02.926' N
Longitude 1	021°15.708
Latitude 2	59°10.886' N
Longitude 2	021°03.865' E
From previous point	
Bearing	322.6 °
Opp. Bearing	142.6 °
Range	10.05 NM
	18608 m
Press Tab to edit manually	

Zoom

Standard **Zoom** cursor  (see document *Multi-Functional Display (v. 3.00.340). Functional Description, Chapter 3, section ECDIS Task Cursors, paragraph Free Cursor*) appears on the Chart panel by pressing the right trackball button.

A press on the left trackball button turns on **Zoom** function, whilst the cursor assumes the form of graphics cursor .

Position the graphic cursor, which will appear, in the corner of the chart fragment required to be viewed. Press the left trackball button. Select the required chart fragment by moving the cursor with the trackball.

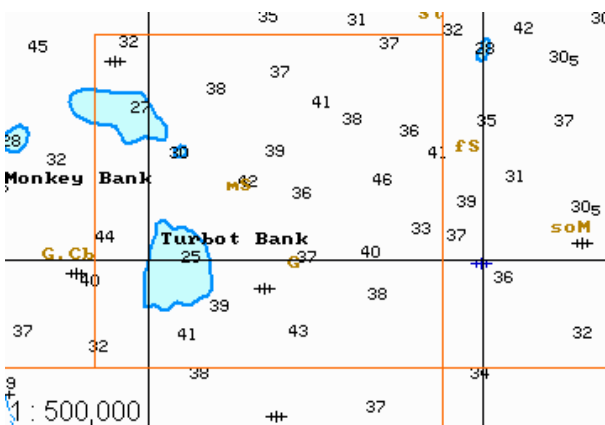

Press the left trackball button. The Chart panel scale will change so that the selected chart fragment is fully displayed on the Chart panel.

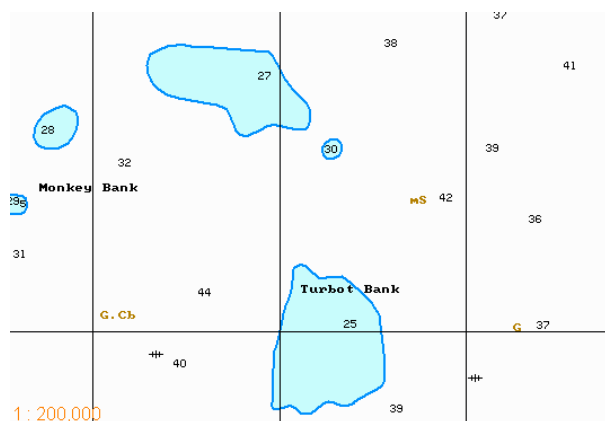

Using Touchscreen Functions

When NS4000 is used as an ECS there is a capability to work with touchscreen monitors. In this case, it is necessary to take into account some special features of work with such monitors. The touchscreen mode is turned on and relevant settings are made in the System Configuration utility at the installation stage (see document *Multi-Functional Display (v. 3.00.340). Installation Guide Part I, Chapter 2, section MFD Configuration, paragraph Workstation Settings, item 2*).

With the touchscreen functionality turned on, to switch the modes of using the free cursor use the relevant buttons which appear in the bottom part in the Chart panel toolbar.

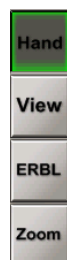

In any mode, you can move the cursor in the Chart panel with a single finger, and you can pinch zoom in and out by using two fingers. If OS Windows 7 is installed, it is possible to move the Chart panel by using two fingers.

When the **Hand** button is activated, the cursor is in no mode, and it is only possible to use the actions described above.

With the **View** button activated, the cursor switches to the chart viewing mode and behaves as described in the *Viewing Charts* paragraph (see above).

The **Review** information window looks like follows:

Review	
Latitude	02°58.435' S
Longitude	007°37.730' W
Ship position	
	true relative
Bearing	249.0 ◀ 111.0 °
Opp. Bearing	069.0 ▶ 069.0 °
Range	490.83 NM
Press Tab to edit manually	
Apply	Cancel

Use the **Apply** button instead of the left trackball button, and **Cancel** instead of the right trackball button.

When the **ERBL** button is activated, the cursor switches to the ERBL mode and behaves as described in the **ERBL** paragraph (see above).

The **ERBL** information window looks like follows:

ERBL - True	
Latitude	54°37.734' N
Longitude	013°56.993' E
Ship position	
	true relative
Bearing	178.8 ◀ 056.1 °
Opp. Bearing	358.8 ▶ 123.9 °
Range	37.30 NM
	69084 m
CPA	30.98 NM
TCPA	52.0 min
Press Tab to edit manually	
Apply	Cancel

Pressing successively the **Apply** button switches the ERBL mode to the ERBL-Relative, ERBL-True, ERBL mode (see document *Multi-Functional Display (v. 3.00.340). Functional Description, Chapter 3, section ECDIS Task Cursors*, paragraph *Free Cursor*).

With the **Zoom** button activated, the cursor switches to the Zoom mode and behaves as described in the **Zoom** paragraph (see above).

The **Zoom** information window looks like follows:

Zoom	
Latitude	56°54.196' N
Longitude	027°29.201' W
Ship position	
	true relative
Bearing	274.2 039.3 °
Opp. Bearing	094.2 140.7 °
Range	1394.14 NM
Press Tab to edit manually	
Apply	Cancel

The first press on the **Apply** button set the top left corner of the zoom area in the cursor position, the second press turns on the zoom mode.

During the input of alphanumeric symbols, rules common for all the modes work in the input boxes.

Tap any digital input window. It should be noted that is this is a box for entering digital values, the built-in input keyboard will appear.

1	2	3	-10	+10
4	5	6	-1	+1
7	8	9	Previous	Next
0	.	-	Cancel	Apply

Enter the necessary value from the keyboard and then press the **Apply** button.

Digital values can also be entered with fingers. Upward/downward motion permits rough increase/decrease of values, whereas leftward/rightward motion increases/decreases values with high accuracy.

When name input boxes are used, an icon of a virtual keyboard built into Windows, appears. Tap any letters input box:

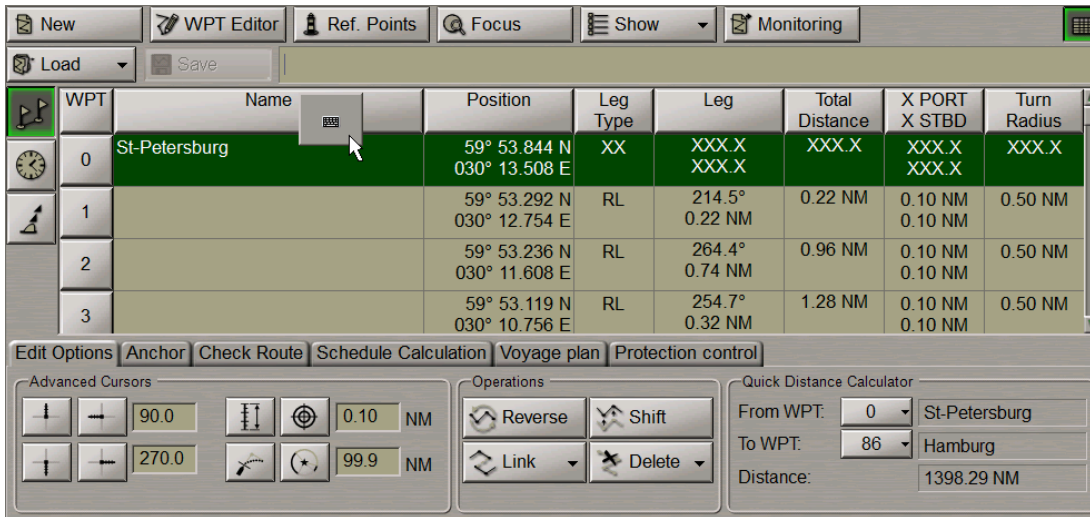

Press on the virtual keyboard icon: the input box will appear.



To enter names, press the button with a picture of keyboard in the top left corner.

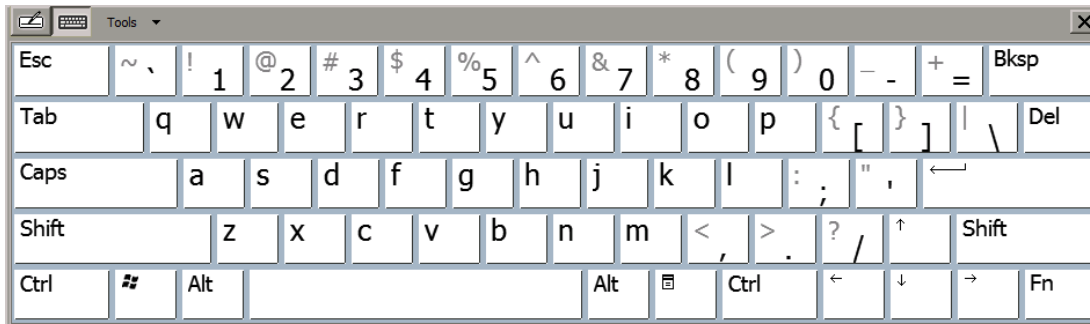

Enter the necessary name by using the virtual keyboard.

EBL/VRM

EBL/VRM/CHL window is intended for turning on and adjusting two independent electronic measurement tools. EBL 1/VRM 1 are shown on the Chart panel as a dashed lines. EBL 2/VRM 2 are shown on the Chart panel as a dashed lines with another length of the dash.

For the variable range marker (VRM) and electronic bearing line (EBL) to be displayed on the ECDIS task Chart panel:

1. To display the first EBL/VRM pair on the ECDIS task Chart panel, press **EBL 1** and **VRM 1** buttons respectively on **EBL/VRM 1** page of **EBL/VRM/CHL** window of the Control panel.



To display the second EBL/VRM pair on the ECDIS task Chart panel, press **EBL 2** and **VRM 2** buttons on **EBL/VRM 2** page respectively.

To set the base point offset of the first EBL/VRM pair relative to the ship position, press **OFFSET** button. The base point will move relative to the current ship position in bearing and distance specified in **EBL** and **VRM** boxes. By default (the **Fixed** button is depressed), the EBL/VRM during offset will be referenced to the selected point on the ground, i.e., it will be moving relative to the own ship at a SOG speed in the direction opposite to the COG. If it is necessary that the EBL/VRM centre move together with the own ship, release the **Fixed** button.

2. By turning <EBL> and <VRM> keys on ES6 keyboard, set the required values of EBL and VRM. Press on <EBL/VRM> key to change between EBL/VRM 1 and 2.

Index Lines

Press the button with the name of the set display in the **Display Panel** window of the Control panel.

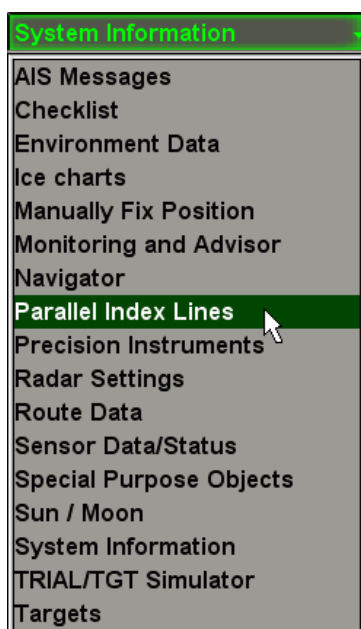

In the list, which will open up, select **Parallel index lines** line and press the left trackball button.

Parallel Index Lines		
Line on/off	Range NM	T BRG DEG
1	0.00	000.0
2	0.00	000.0
Show All		Reset

Press the button with index line number. Position the free cursor in the **Range** input field and press the left button.

Line on/off	Range NM	T BRG DEG
1	2.00	000.0
2	0.00	000.0
Show All		Reset

By rolling the trackball, set the required value of distance from the centre of the own ship mark, or enter it from the keyboard. Press the left trackball button. The index line will be set at the specified distance.

Note: Distance to the index line is measured along the perpendicular dropped from the own ship mark centre to the index line.

Position the free cursor in the **T BRG** input field and press the left trackball button.

Line on/off	Range NM	T BRG DEG
1	2.00	270.0
2	0.00	000.0
Show All		Reset

By rolling trackball, set the required value of the index line bearing or enter it from the keyboard. Press the left trackball button. The index line will be set in the specified direction.

Note: 0° bearing corresponds to the line direction to the north. The index line bearing varies from 0° to 360°. On the reciprocal bearings, the line direction is the same, but it is located on different sides of the own ship mark.

To set the index line bearing value equal to the current ship course, press the **Reset** button.

To turn on/off the display of all the parallel index lines on the ECDIS task screen press the **Show All** button.

Quick Distance Tool

For the Quick Distance Tool operation, press the  button on the Chart panel toolbar.



Select the necessary method of distance measurement.

Graphics cursor (see document *Multi-Functional Display (v. 3.00.340). Functional Description, Chapter 3, section ECDIS Task Cursors*, paragraph *Free Cursor*) appears on the Chart panel. 

Position the graphics cursor on the initial measurement point on the Chart panel and press the left trackball button.

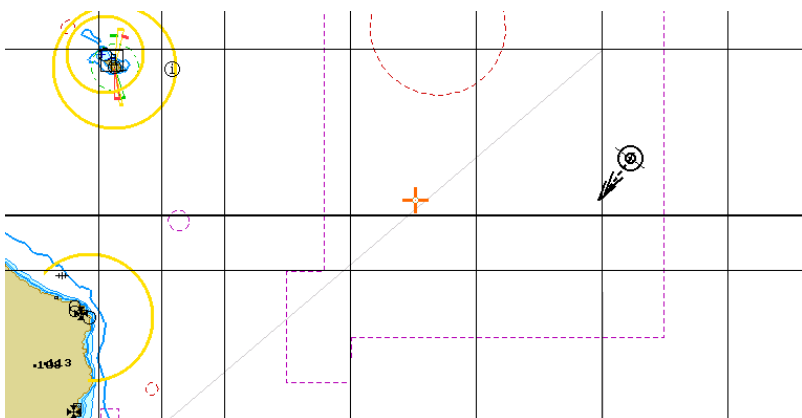

Position the graphics cursor on the next point on the Chart panel and press the left trackball button. The distance measured from the initial point and bearing from the initial to the set point will be shown on the Chart panel.

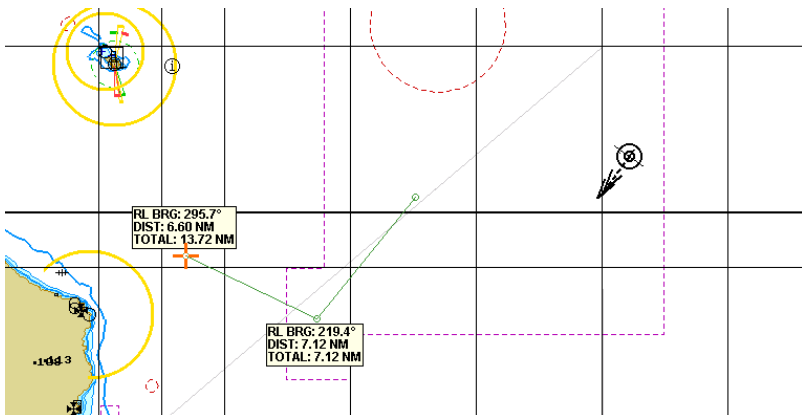

Set the necessary number of points for the distance measurements.

Quick Distance Tool - RL	
Latitude 1	55°10.528' N
Longitude 1	015°16.944' E
Latitude 2	55°10.528' N
Longitude 2	015°16.944' E
From previous point	
Bearing	000.0 °
Opp. Bearing	180.0 °
Range	0.00 NM
	0 m
Total distance	13.72 NM
	25405 m
Press Tab to edit manually	

The information window in the bottom part of the Control panel displays the following data:

- **Latitude 1/Longitude 1** – coordinates of the graphics cursor;
- **Latitude 2/Longitude 2** – coordinates of the last set measurement point;
- **Bearing/Opp. Bearing** – bearing (reverse bearing from the last set point to the cursor);
- **Range** – distance from the last set point to the cursor;
- **Total distance** – total distance from the first set point to the cursor.

To exit from the graphics cursor mode, press the right trackball button.

Manual Entry in the Ship Log

There are two ways to make a ship log entry on the entire set of events as of the current moment:

- Press Event **Event** button in the **Operational** window on the Chart panel:

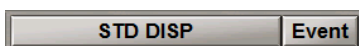

- Press <EVENT> key on the ES6 keyboard.

An entry will be made on the Electronic system logbook, and a special mark will be made on the own ship track.

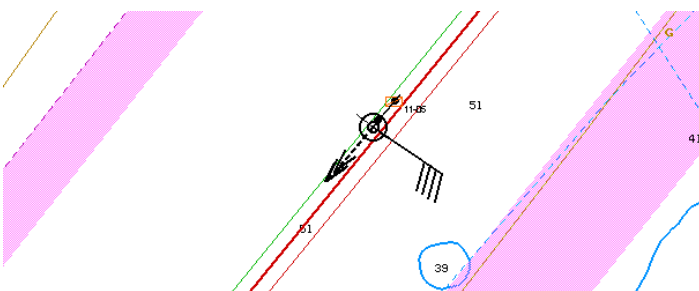

Chapter 4.

Navigation Tasks

This chapter describes the procedure used during the operation in the navigation mode.

<u>Setting Position Sources</u>	77
Setting Electronic Position Fixing System (EPFS)	77
Setting ER Mode	81
Setting EP Mode	86
Setting DR Mode	87
Display of Non-Primary Positioning System Symbol on ECDIS Task Screen	89
Use of Manually Fix Position for Determining Ship Position	90
<u>Setting Heading Source</u>	97
<u>Setting Speed Sources</u>	98
Setting Speed Source Through the Water	99
Setting Speed Source Over the Ground	100
<u>Setting Depth Source</u>	101
<u>Obtaining Current Information about Navigational Data</u>	102
<u>Loading of Route and Schedule in the Navigation Mode</u>	104
Setting Lead Distance (F-dist)	104
Loading Route	105
Selection of Safety Parameters when Loading Monitored Route	109
Loading Schedule	112
Obtaining Current Information about Monitoring Route and Schedule	114
Unloading Route and Schedule	117
<u>Handling Charts and Chart Information</u>	118
Prompt Search and Load Charts	118
Loading and Scaling Charts under Own Ship Position	119
Switching Chart Information Layers	125
Handling ENC Format Charts	129
Handling AIO Chart	131
Handling TOD0 Charts	135
<u>Using Auto Zoom Function</u>	137

<u>Using the Mooring Mode</u>	138
<u>Search and Rescue Operations</u>	139
Using Man Overboard (MOB) Mode	139
Creating SAR Routes	142
<u>Using Special Purpose Objects</u>	149
SPO Creating	150
SPO Deleting	152
Other Functions	152
Saving and Loading SPO Configuration	153

Setting Position Sources



Attention! Setting of position sources is available only at station with the status MASTER.

Open **Sensors** panel by selecting the appropriate line of **Tasks List** menu in the tabs zone of the ECDIS task screen.

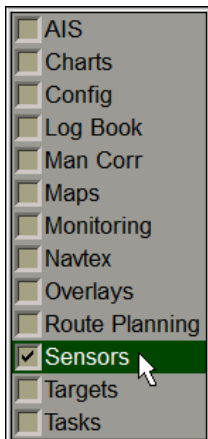

Use the tab in the top part of **Sensors** panel, which will open up, to switch to **Ship Position** page:

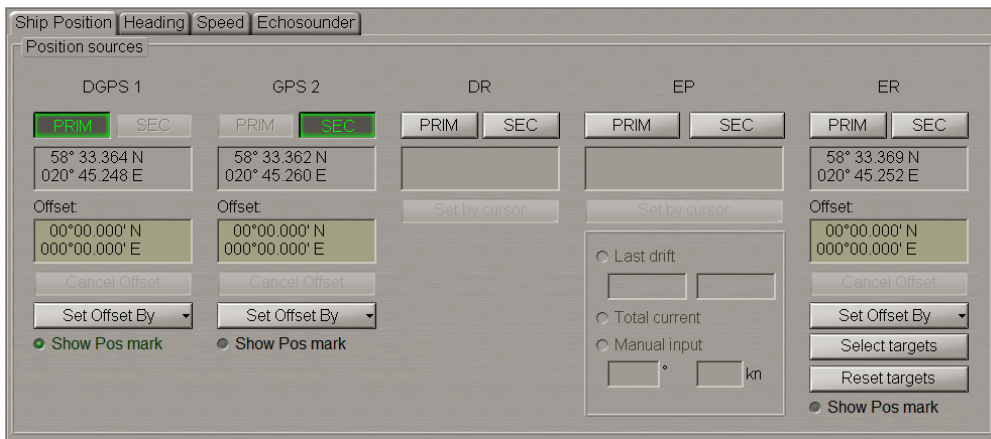

Ship Position page is designed for selection of position source. **Ship position** page displays all the connected coordinates sensors, as well as Dead Reckoning (DR) and Echo Reference (ER) modes.

Setting Electronic Position Fixing System (EPFS)



The group of each EPFS source contains the following elements:

- **PRIM** – to select the source as primary positioning system; the window is intended for display of the current coordinates received from the positioning system;
- **SEC** – to select the source as secondary positioning system; the window is intended for display of the current coordinates received from the positioning system;
- Position window for the coordinates display;
- **Offset** – window for the input and display of the ship position coordinates offset;
- **Cancel Offset** – to cancel the entered corrections;
- **Set Offset By** – to enter the correction by specifying new coordinates with the ECDIS task graphic cursor.

Press **PRIM** and **SEC** buttons to select the primary and secondary positioning systems.

To monitor parameters of the EPFS used for the primary positioning system, press the button with the name of the set display in the **Display Panel** window of the Control panel.

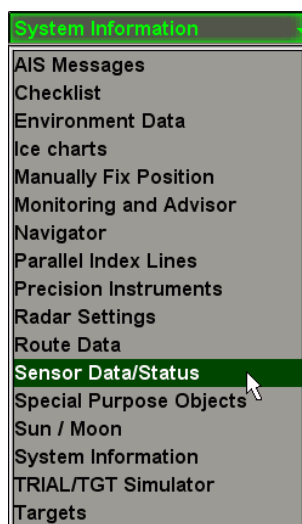

In the list, which will open up, select **Sensor Data/Status** line and press the left trackball button.

Use the tab in the top part of the **Sensor Data/Status** display panel which will open up, to switch to the **Primary Status** page.

Sensor data/status	
Primary Status	AIS VDL Data
Fixed UTC	21 : 36 : 24
Latitude	56° 48.766 N
Longitude	018° 21.135 E
Quality	DGPS SPS
Satellites	5
HDOP	1.0
Data age	10.0
Station ID	0000
RMS 95%	20 m

Primary Status page is used for presenting the following data from EPFS, which used as primary positioning system:

- **Fixed UTC** – UTC time which the data is provided for;
- **Latitude** – latitude coordinate;
- **Longitude** – longitude coordinate;
- **Quality** – positioning quality indicator (GPS operating mode);
- **Satellites** – number of satellites used for the positioning;
- **HDOP** – HDOP (Horizontal Dilution of Precision) value;
- **Data age** – age of differential corrections;
- **Station ID** – name of the station, which transmits differential corrections for the DGPS used by the primary positioning system (where the differential mode is used);
- **RMS 95%** – ship position 95% RMS error (for the 95% RMS error calculation algorithm, see document *Multi-Functional Display (v. 3.00.340). Functional Description, Chapter 2, section Navigational Sensors, paragraph Positioning, under RMS Calculations for Different Positioning Systems*).

In the absence of data from PS positioning systems (or in absence of valid GGA sentence), there are empty fields on the display.

To enter the EPFS offset, use the following procedure:

1. To manual input. Position the cursor in **Offset** window on the minute value and press the left trackball button to activate the window. Enter the coordinate offset and press <Enter> key.

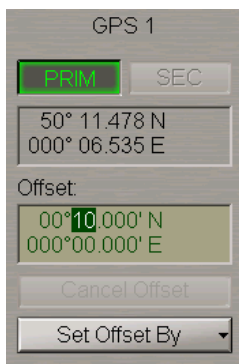

The ship symbol will move to the corrected coordinates, the coordinate offset will be displayed in **Offset** window, whilst position window will show corrected coordinates from position source.

2. Input EPFS offset by the cursor. Press **Set Offset By** button position source group and select **Cursor**.

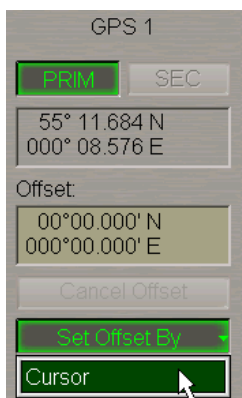

Move the graphic cursor, which will appear, to the corrected ship position coordinates.



Press the left trackball button. The ship symbol will move to the specified coordinates.

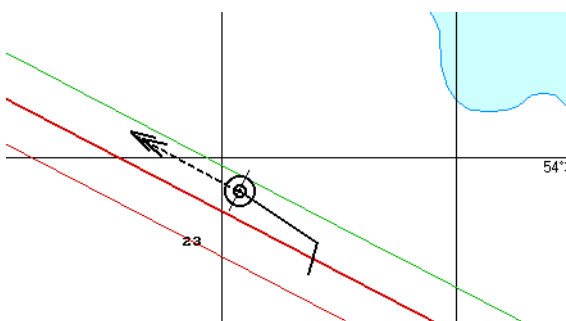

The coordinate offset will be shown in **Offset** window, whilst position window will display corrected coordinates from position systems.

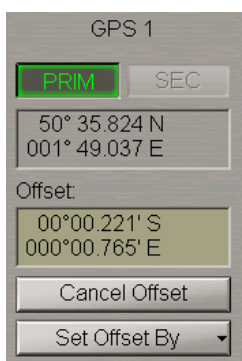

Setting ER Mode

ER group contains the following elements:

- **PRIM** – to select ER mode as primary positioning system;
- **SEC** – to select ER mode as secondary positioning system;
- Position window for the coordinates display;
- **Offset** – window for the input and display of the ship position coordinates offset;
- **Cancel Offset** – to cancel the entered corrections;
- **Set Offset By** – to enter the correction by specifying new coordinates with the ECDIS task graphic cursor;
- **Select targets** – to select targets as fixed reference points (button is enabled if at least one steadily tracked target is available);
- **Reset targets** – to cancel reference points.

To set the ER mode, it is first necessary to set the reference points. Press the **ARPA** button in the top part of the Control panel to turn on the display of targets.



Note: If at least one steadily tracked target is available, **Select targets** button will be activated.

Press **Select targets** button.

Position the free cursor on the tracked target, which will serve as a reference point.

Note: Any ARPA tracked stationary target can serve as a reference point.

As this is done, the cursor will assume the following form: 

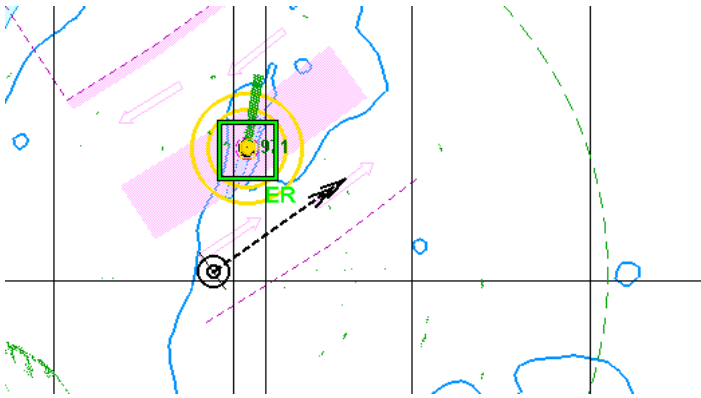

Press the left trackball button.

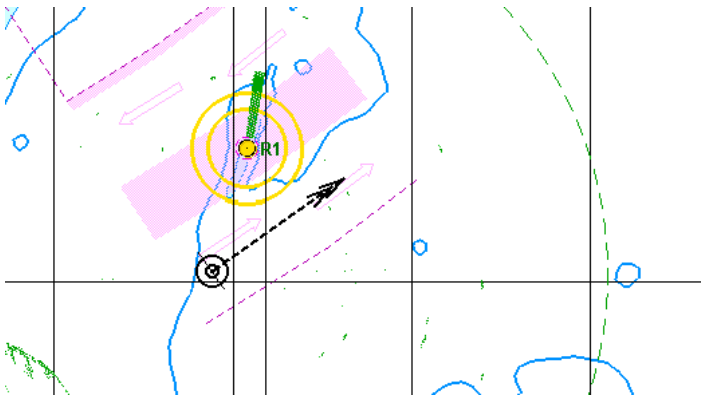

“R” index will show up next to the reference point. Set the necessary number of reference points (up to 5). To use position determined with the aid of reference points in ER group, press **PRIM** or **SEC** button.

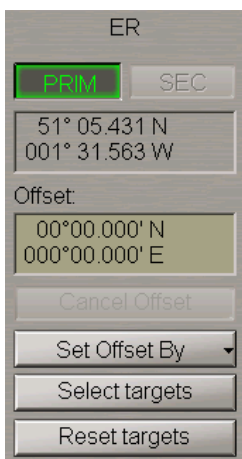

To monitor parameters of the ER mode, press the button with the name of the set display in the **Display Panel** window of the Control panel.

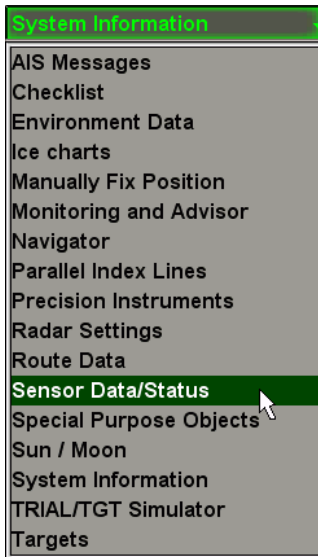

In the list, which will open up, select **Sensor data/status** line and press the left trackball button.

Use the tab in the top part of the **Sensor data/status** display panel which will open up, to switch to the **Primary Status** page.

The image shows the 'Sensor data/status' display panel. At the top, there is a dropdown menu set to 'Sensor data/status' and a small icon. Below it, there are two tabs: 'Primary Status' (selected) and 'AIS VDL Data'. The main content area is titled 'List of ER targets' and contains a table with three columns: 'Tgt Id', 'Brg-Dist (nm)', and 'RMS 95%'. The table has three rows of data. At the bottom of the panel, there is a summary line: 'Total RMS = 773 metres'.

Tgt Id	Brg-Dist (nm)	RMS 95%
R1	015.8° 96.2	774
R2	136.4° 3.1	312
R3	127.8° 3.5	337
Total RMS = 773 metres		

Primary Status page is used for presenting the list of ER targets:

- **Tgt Id** – reference point ID;
- **Brg-Dist** – bearing and distance to the reference point;
- **RMS 95%** – 95% RMS error for each reference point;
- **Total RMS** – the maximum 95% RMS error among all the reference points (for the 95% RMS error calculation algorithm, see document *Multi-Functional Display (v. 3.00.340). Functional Description, Chapter 2, section Navigational Sensors*, paragraph *Positioning*, under *RMS Calculations for Different Positioning Systems*).

To cancel the reference point, press **Reset targets** button.

Position the free cursor on the reference point, which will cancel.

As this is done, the cursor will assume the following form: 

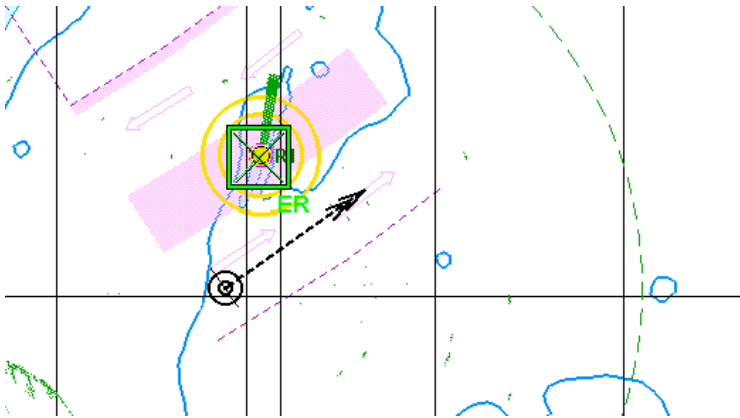

Press the left trackball button.

“R” index will stop show up next to the reference point.

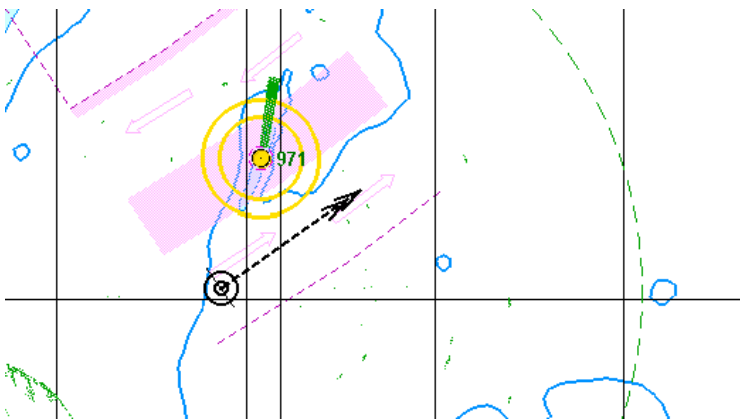

The position offset by cursor for the ER is entered in much the same way as for the EPFS (see the previous paragraph). To enter the ER offset, use the following procedure:

1. The position offset manually and by cursor for the ER is entered in much the same way as for the EPFS (see the previous paragraph).
2. The position offset by target. Press **Set Offset By** button position source group and select **Target**.

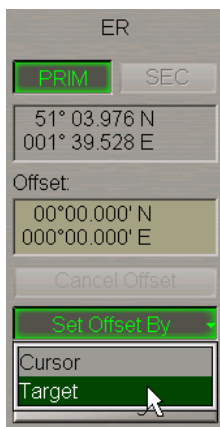

Position the acquisition marker which will appear, on the required reference point.

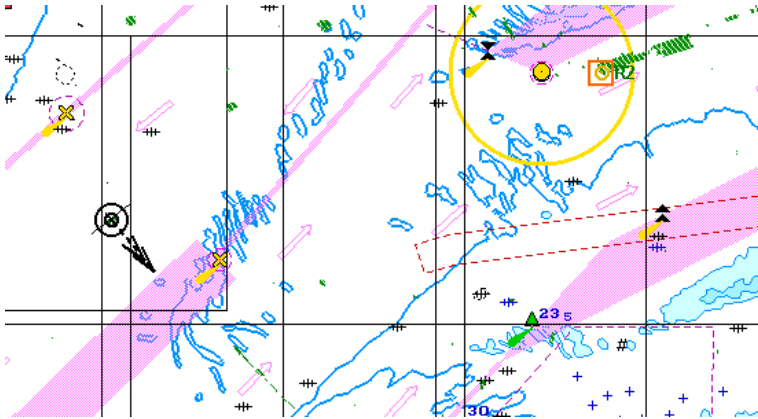

Press the left trackball button. The marker will “acquire” the reference point and change own form. Set the cursor in the new coordinates corresponding to the reference point on chart.

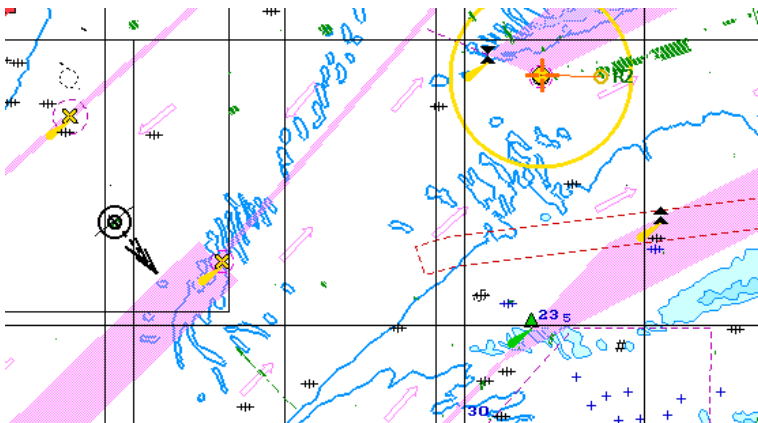

Press the left trackball button. The ship symbol (as well as the radar scanning centre if displayed) will move to the calculated coordinates.

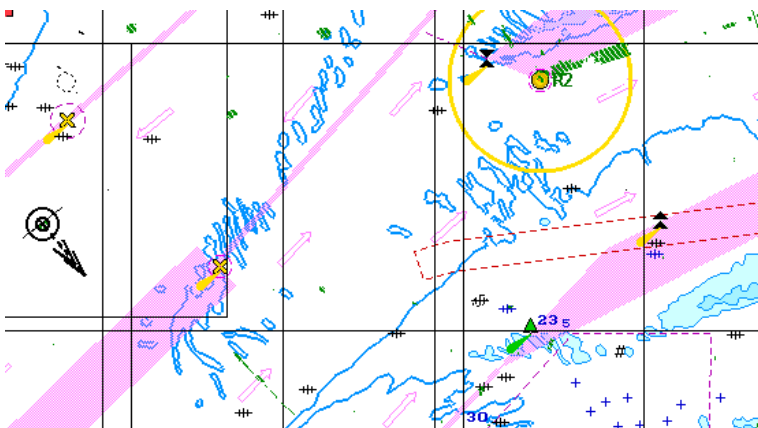

Setting EP Mode



EP group is intended for setting parameters used in the EP (corrected DR) mode and contains the following elements:

- **PRIM** – to select DR mode as primary positioning system;
- **SEC** – to select DR mode as secondary positioning system;
- Position window for the display and input of coordinates;
- **Set by cursor** – to enter the position by specifying new coordinates with the ECDIS task graphics cursor;
- **Last drift** – to use the last calculated drift parameters;
- **Total current** – to use parameters of drift caused by total tidal and surface current from the database;
- **Manual input** – to enter drift parameters manually (0–360 degrees/0.0–9.9 knots).

In EP group press **PRIM** or **SEC** button. Enter current ship position in the input window.

In this case the name of the position source displayed in the **Primary (Secondary)** window of the Control panel will be shown in yellow (see also document *Multi-Functional Display (v. 3.00.340). Functional Description, Chapter 4, section Indications, paragraph Display of Important Indications*).

Prim	56° 15.684 N
EP:Drift	017° 01.092 E

To input EP by cursor, press **Set by cursor** button.

Move the graphic cursor, which will appear, to the corrected ship position coordinates.

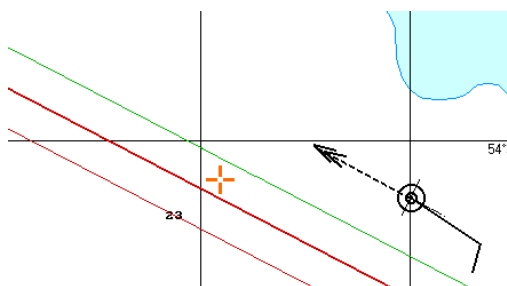

Press the left trackball button. The ship symbol will move to the specified coordinates.

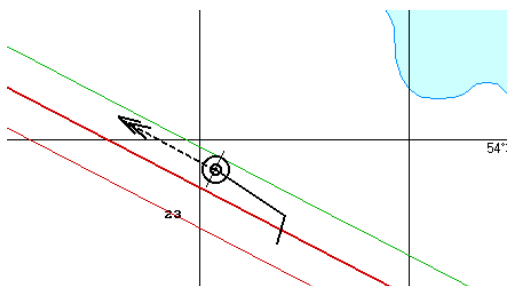

Position window will display new coordinates from EP.

Setting DR Mode

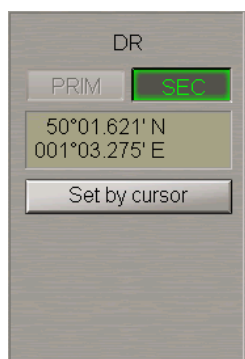

DR group contains the following elements:

- **PRIM** – to select DR mode as primary positioning system;
- **SEC** – to select DR mode as secondary positioning system;
- Position window for the display and input of coordinates;
- **Set by cursor** – to enter the position by specifying new coordinates with the ECDIS task graphics cursor.

In DR group press **PRIM** or **SEC** button. Enter current ship position in the input window.

In this case the name of the position source displayed in the **Primary (Secondary)** window of the Control panel will be shown in yellow (see also document *Multi-Functional Display (v. 3.00.340). Functional Description, Chapter 4, section Indications, paragraph Display of Important Indications*).

Prim	56° 15.684 N
DR	017° 01.092 E

To input DR by cursor, press **Set by cursor** button.

Move the graphic cursor, which will appear, to the corrected ship position coordinates.

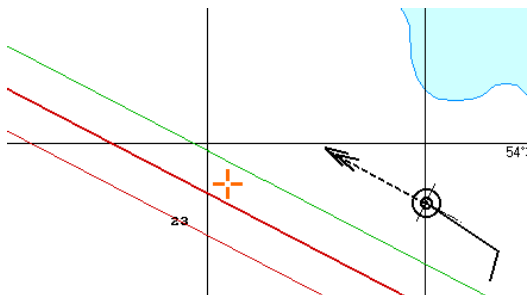

Press the left trackball button. The ship symbol will move to the specified coordinates.

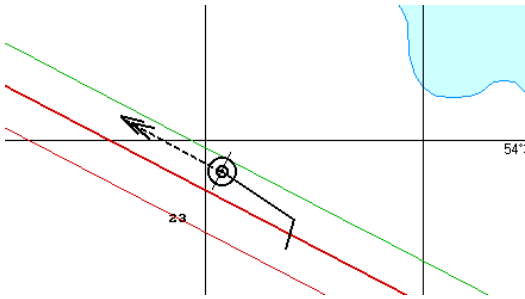

Position window will display new coordinates from DR.

To monitor parameters of the DR mode, press the button with the name of the set display in the **Display Panel** window of the Control panel.

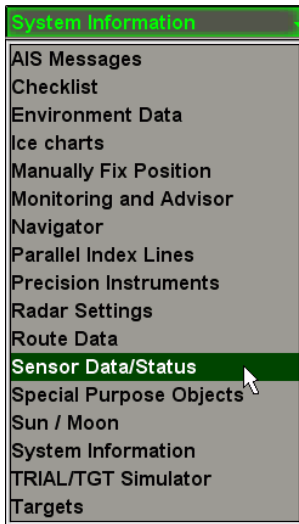

In the list, which will open up, select **Sensor data/status** line and press the left trackball button.

Use the tab in the top part of the **Sensor data/status** display panel which will open up, to switch to the **Primary Status** page.

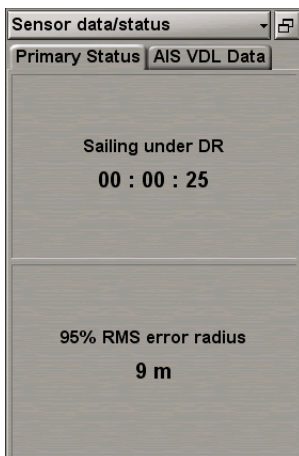

Primary Status page is used for presenting the following parameters:

- Sailing under DR – time of sailing in DR ship positioning mode;
- 95% RMS error radius – ship position 95% RMS error (for the 95% RMS error calculation algorithm, see document *Multi-Functional Display (v. 3.00.340). Functional Description, Chapter 2, section Navigational Sensors*, paragraph *Positioning*, under *RMS Calculations for Different Positioning Systems*).

Display of Non-Primary Positioning System Symbol on ECDIS Task Screen

There is a capability to display the own ship position from the Non-Primary positioning systems.

Use the tab in the top part of **Sensors** panel, which will open up, to switch to **Ship Position** page.

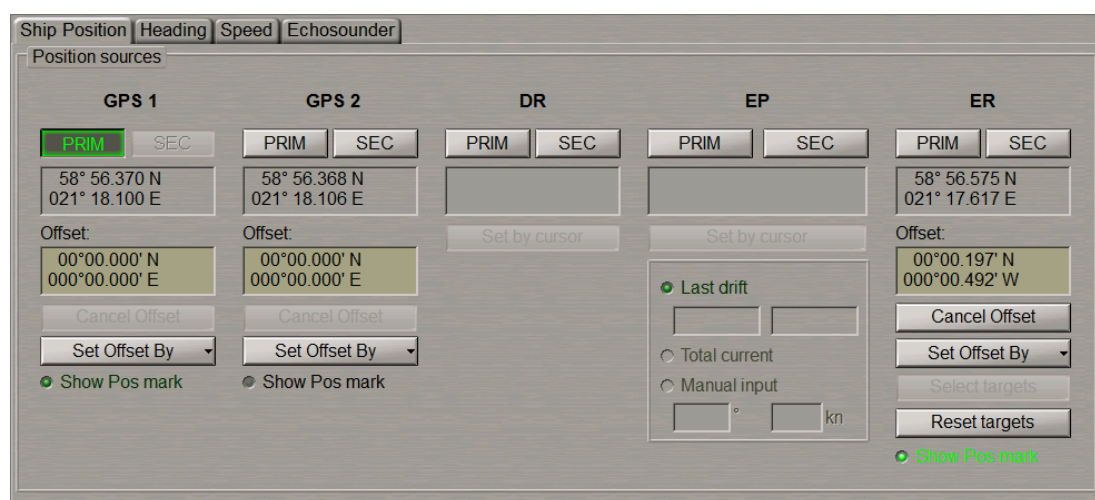

To this end, check the **Show Pos mark** checkbox of the relevant positioning system.

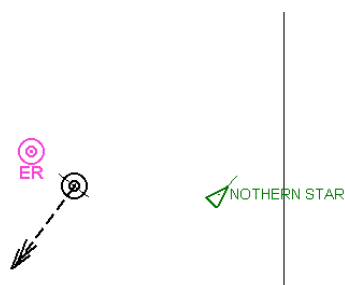

The own ship symbols will be displayed on the ECDIS task screen.

Use of Manually Fix Position for Determining Ship Position

Press the button with the name of the set display in the **Display Panel** window of the Control panel.

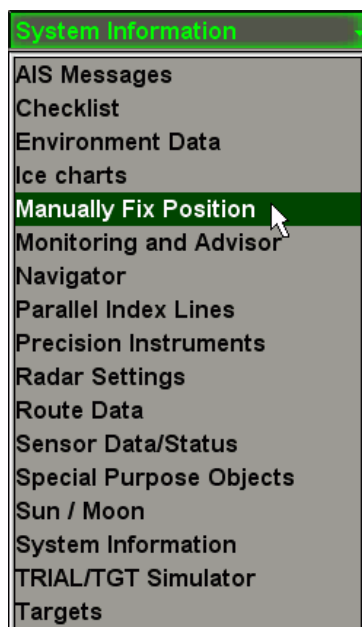

In the list which will open up, select **Manually Fix Position** line and press the left trackball button.

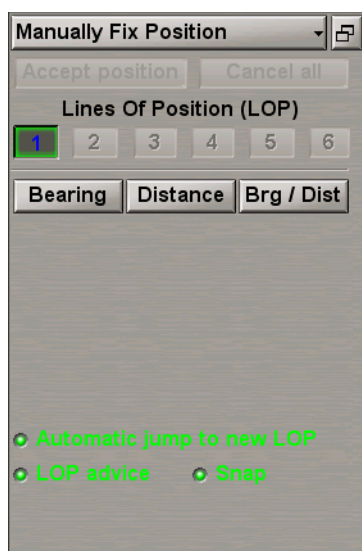

Manually Fix Position display is intended for constructing the ship line of position (LOP) by measuring bearing and/or range to one or more visible objects whose coordinates are known in advance (or the object can be uniquely identified on the chart).

The display contains the following items:

- **Accept position** – to record the calculated ship position on the chart and in the Ship Logbook (when the DR positioning system is used, to enter calculated coordinates for further computation);
- **Cancel all** – to cancel all the measurements which have been made;

- 1...6 – to switch bearing and/or range measurements. That number of buttons is active which is equal to the number of measurements which have been made, the rest are disabled. Depending on the measurement status, the buttons have the following colours:
 - black – bearing/range determined and referenced to the chart conspicuous point;
 - red – measurement taken and referenced, but the system considers it incorrect on the basis of LOP being at a distance of more than one mile from the reckoned position (with **LOP advice** function ON only);
 - blue – free cell for setting the measurement;
 - white – the data is entered, but the position line is not referenced by the user.
- **Bearing** – to enter bearing;
- **Distance** – to enter range;
- **Brg/Dist** – to enter simultaneously the bearing and distance to one object;
- **Automatic jump to new LOP** – to turn on automatic transfer to the next measurement after the input of LOP data without referencing to an object;
- **LOP advise** – to turn on the function providing a warning that the position line is more than 1 mile away from the reckoned position. In this case, the button with the measurement number turns red;
- **Snap** – LOP automatic referencing to objects.

Press **Bearing** button. After the selection of the measurement type, **Manually Fix Position** display looks like shown in the drawing below:

In this case, depending on the measurement type, the display contains the following items:

- **Time** – time of the current measurement data input;
- **D** – difference between the input of the first and current measurement data in minutes and seconds;
- **Brg** – to enter bearing to the object;

- **Name** – name or type of the object which is referenced to with the Snap to Object function turned on (see document *Multi-Functional Display (v. 3.00.340). Functional Description, Chapter 3, section Manually Fixed Position, paragraph Line of Position Referencing*);
- **Apply** – to confirm the entered current measurement data. With **Automatic jump to new LOP** function ON, there is an automatic transfer to the input of the next measurement;
- **Cancel** – to cancel the entered current measurement data.

Enter the bearing to the object in **Brg** input box by using the trackball or keyboard. Press the left trackball button.

Note: Measurement time in **Time** box is set at the current time minus 5 seconds.

Press the activated **Apply** button.

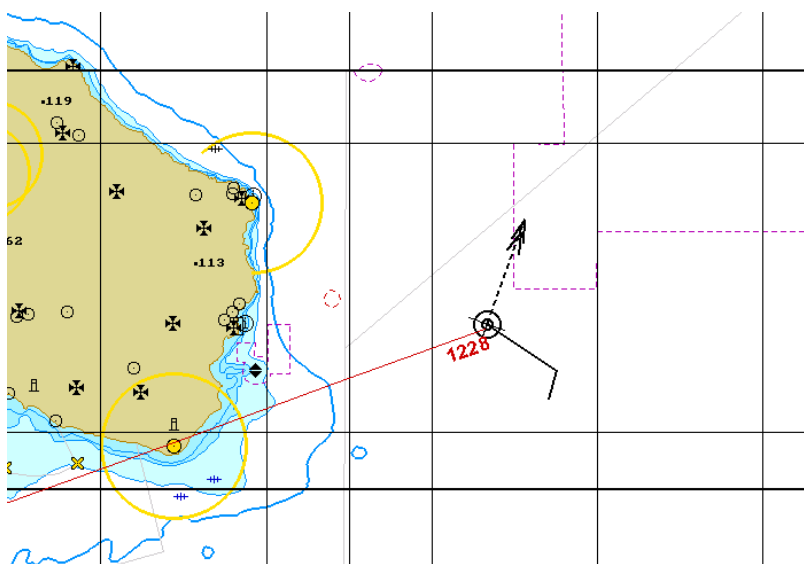

A red coloured line will be drawn on the Chart panel, with the measurement time specified.

Use the button in the top part of **Manually Fix Position** display to switch to the next measurement (if **Automatic jump to new LOP** function is ON, the switching is made automatically).

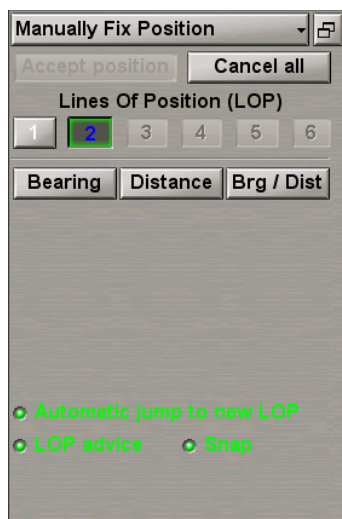

Press Distance button.

Manually Fix Position

Accept position Cancel all

Lines Of Position (LOP)

1 2 3 4 5 6

Time: 12:29:22 D: 00:58

Dist: 9.11 NM

Name: _____

Apply Cancel

Automatic jump to new LOP

LOP advice Snap

Enter the distance to the object in Dist input box by using the trackball or keyboard. Press the left trackball button.

Press the activated Apply button.

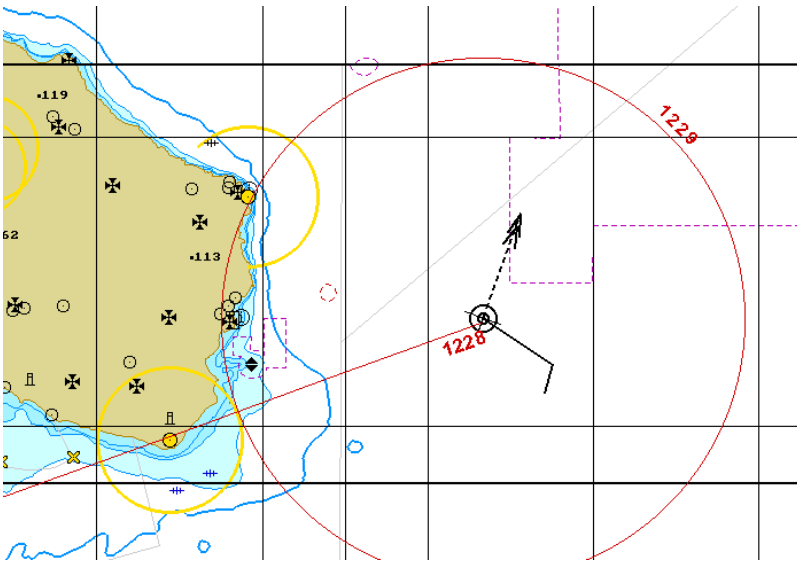

A red coloured position line will appear on the Chart panel.

To reference the position lines, press the button with the first measurement number in **Manually Fix Position** display. After the confirmation of the entered current measurement data, **Manually Fix Position** display looks like shown below:



In this case, the display contains the following items:

- **Move and reference** – to reference the position line to a chart object;
- **Delete** – to cancel the entered current measurement data.

Press **Move and reference** button.

On the Chart panel, bring the beginning of the position line in coincidence with the object which the bearing was measured to (if the **Snap to object** checkbox is checked, the LOP will be referenced to the object automatically if it is not farther than 0.5 mile from its beginning). Press the left trackball button.

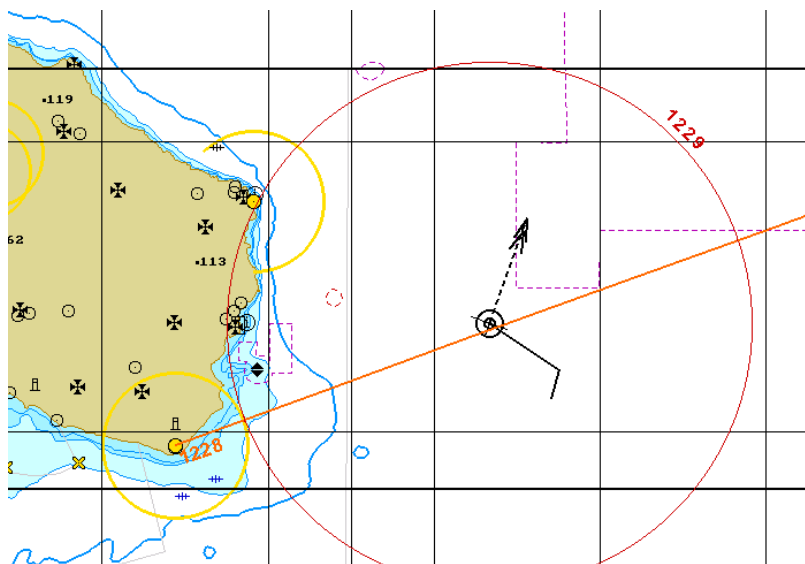

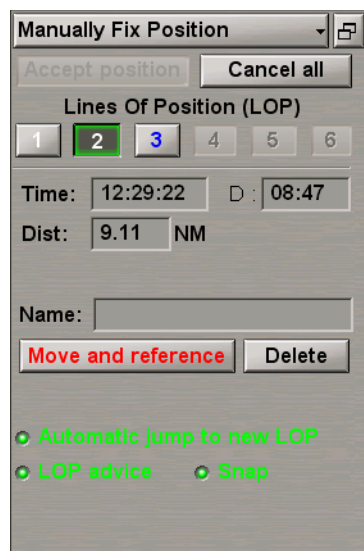

To bind the next position line, press the button with the next measurement number in **Manually Fix Position** display.

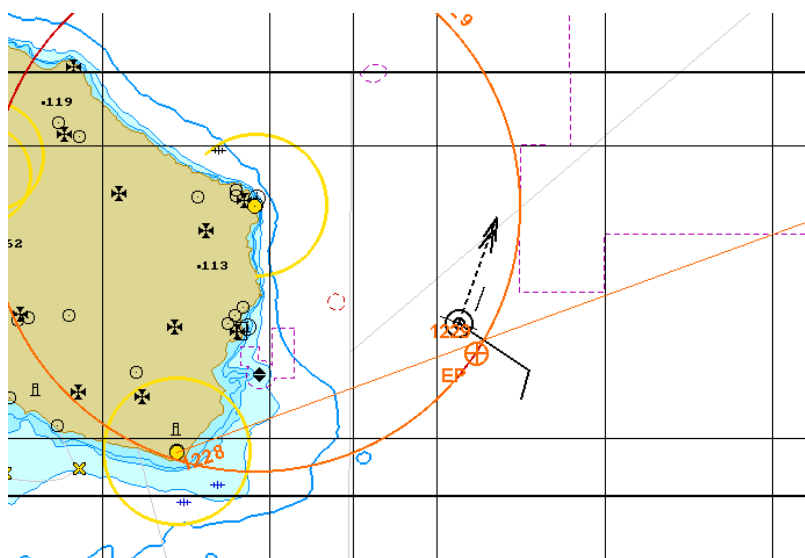

Press **Move and reference** button.

On the Chart panel, bring the centre of the position line circle into coincidence with the object which the distance was measured to (if the **Snap** checkbox is checked, the LOP will be referenced to the object automatically if it is not farther than 0.5 mile from its centre). Press the left trackball button.



The position line will be bound to the object and will be displayed in the orange colour. After the binding of two position lines, the orange coloured  symbol will appear on the Chart panel in the point with coordinates of the calculated ship position. Specified next to the symbol are the letters “EP” and the most recent calculation time.

Construct the necessary number of position lines.

If it is necessary to accept the results of manually fix position, use **Accept position** button (see also document *Multi-Functional Display (v. 3.00.340). Functional Description, Chapter 3, section Manually Fixed Position*).

If an Optical Bearing Device (OBD) is connected to the MFD, a button for turning on the bearing line presentation appears on the **Manually Fix Position** display.



The OBD continuously transmits bearing information to the MFD. This allows the ECDIS task screen to provide a real-time display of an Optical Bearing Line – showing what the OBD operator is looking/pointing at.

Press **OBD: show Bearing Line** button.

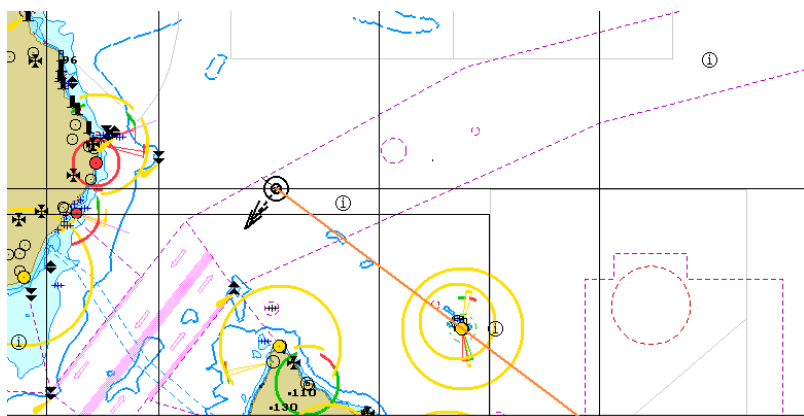

The Chart panel will show the Optical Bearing Line in the form of a yellow line.

After the OBD operator has fixed a position, the Chart panel will display a LOP with the measurement time.

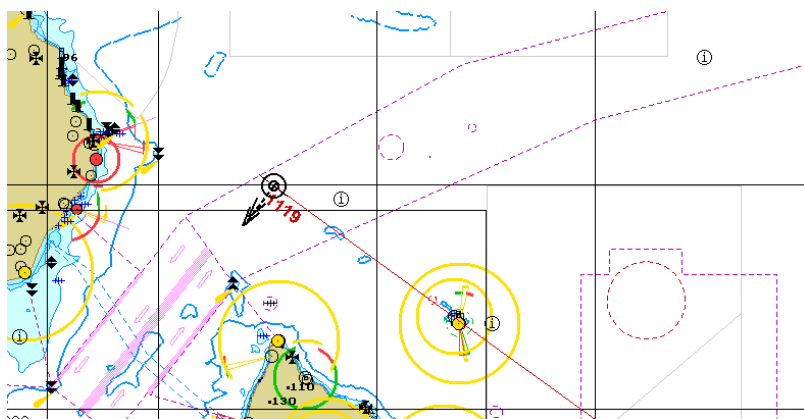

At the same time, the obtained bearing will be accepted as a measurement for the Manually Fix Position Method.

Manually Fix Position

Accept position Cancel all

Lines Of Position (LOP)

1 2 3 4 5 6

Time: 11:18:33 D: 00:00

Brg: 126.0 °

Name:

Move and reference Delete

Automatic jump to new LOP

LOP advice Snap

OBD: show Bearing Line

Data from the OBD will be displayed in the **Brg** input boxes and can be subsequently used for further calculations (see above).

Setting Heading Source



Attention! Setting of heading sources is available only at station with the status MASTER.

Open **Sensors** panel by selecting the appropriate line of **Tasks List** menu in the tabs zone of the ECDIS task screen.

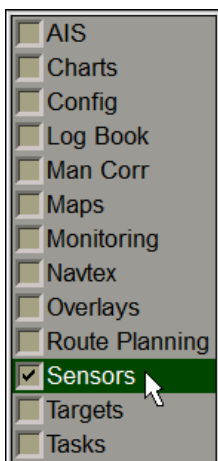

Use the tab in the top part of **Sensors** panel to switch to **Heading** page:

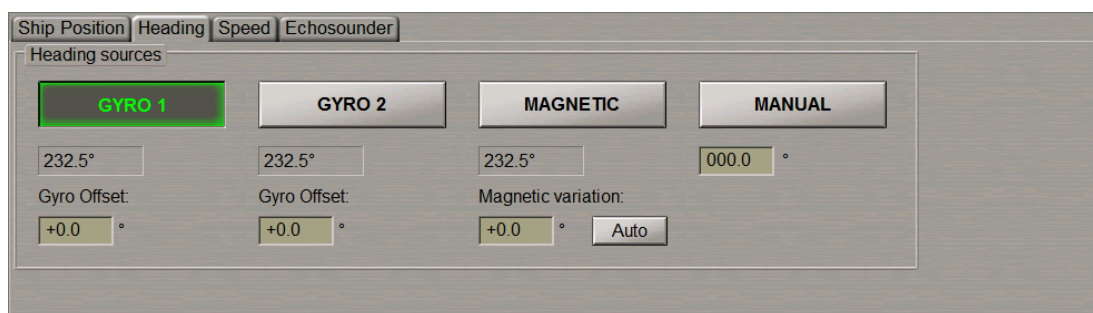

Heading page is designed for selection of heading source. **Heading** page shows all the connected heading sensors.

The group of each heading source contains the following elements:

- **GYRO 1** – to select this sensor as heading source; the window is intended for display heading value from the sensor;
- **Gyro Offset** – for the manual input of the gyro offset (for gyro compass);
- **Magnetic variation** – for the input of the magnetic variation from the database (**Auto** button), or manually in the input window (for magnetic compass);
- **MANUAL** – to select the use of manual heading input; the window is intended for heading input.

Press the button with the source name to select the main source of heading whose data will henceforth be used for making all the calculations in the system.

If necessary, enter errors (see document *Multi-Functional Display (v. 3.00.340). Functional Description, Chapter 2*, section *Navigational Sensors*, paragraph *Compensations for Navigational Data*) for gyro and variation for magnetic compass.

Setting Speed Sources



Attention! Setting of speed sources is available only at station with the status MASTER.

Open **Sensors** panel by selecting the appropriate line of **Tasks List** menu in the tabs zone of the ECDIS task screen.

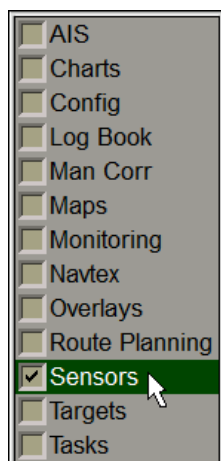

Use the tab in the top part of **Sensors** panel to switch to **Speed** page.

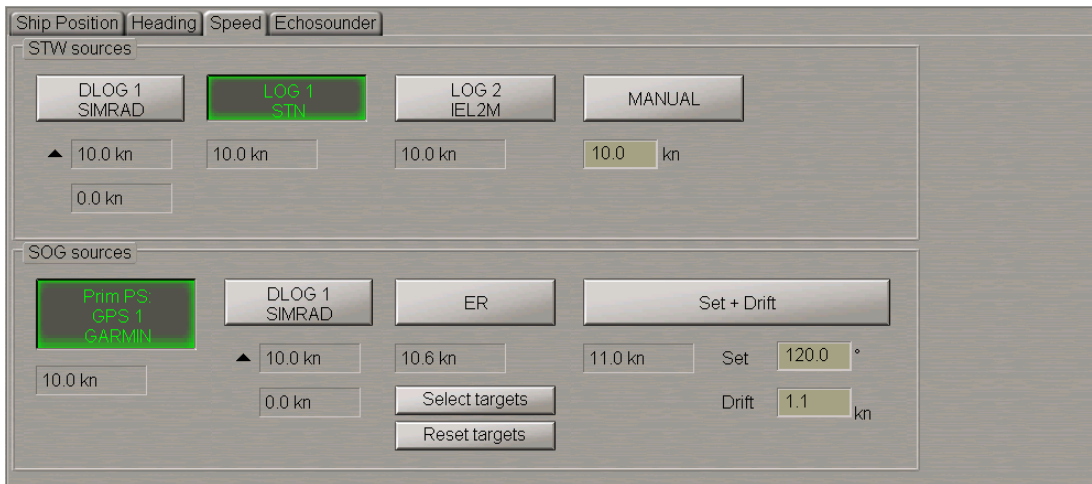

Speed page is designed for selection of speed source.

Setting Speed Source Through the Water



STW sources group is designed for selection a source of speed through the water. The group shows all the connected speed through the water sensors.

The group of each speed through the water source can contain the following elements:

- **DLOG** – to select DLOG as a source of STW; the windows are intended for display longitudinal and transverse component of the speed-through-water vector, the arrows showing the direction of components;
- **LOG** – to select LOG as a source of speed through the water; the window is intended for display STW value from log;
- **MANUAL** – to select the use of manual STW input; the window is intended for speed input.

Press the button with the source name to select the source of speed through the water, whose data will henceforth be used for making all the calculations in the system.

Setting Speed Source Over the Ground

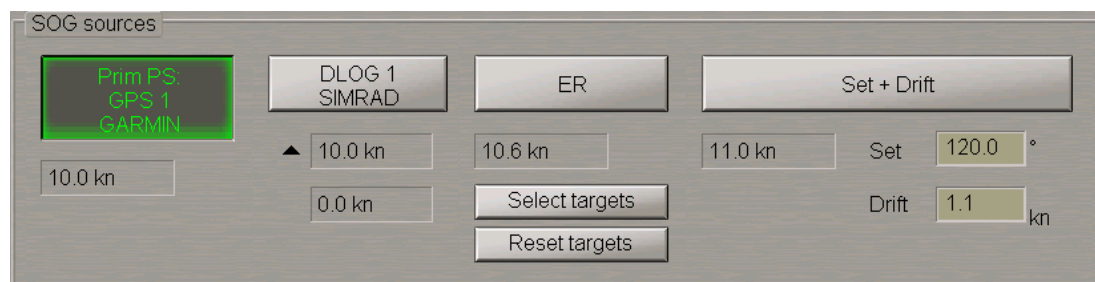

SOG sources group is designed for selection a source of speed over ground. The group shows all the connected speed over ground sensors.

The group of each speed over ground source can contain the following elements:

- **Prim PS: GPS 1** – to select EPFS as a source of SOG; the window is intended for display SOG value from EPFS;
- **DLOG** – to select DLOG as a source of SOG; the windows are intended for display longitudinal and transverse component of the SOG vector, the arrows showing the direction of components;
- **ER** – to select ER mode as a source of SOG; the window is intended for display SOG value; the buttons is intended for:
 - **Select targets** – to select targets as fixed reference points (button is enabled if at least one steadily tracked target is available);
 - **Reset targets** – to cancel reference points.
- **STW + Drift** – to select STW as SOG, manual drift input taken into account. The window is intended for display SOG value. The input windows are intended for:
 - **Set** – to display and manually enter the set;
 - **Drift** – to display and manually enter the drift.

Press the button with the source name to select the source of speed over ground whose data will henceforth be used for making all the calculations in the system.

Setting Depth Source



Attention! Setting of depth sources is available only at station with the status MASTER.

Open **Sensors** panel by selecting the appropriate line of **Tasks List** menu in the tabs zone of the ECDIS task screen.

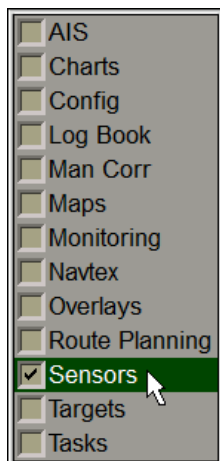

Use the tab in the top part of **Sensors** panel to switch to **Echosounder** page:

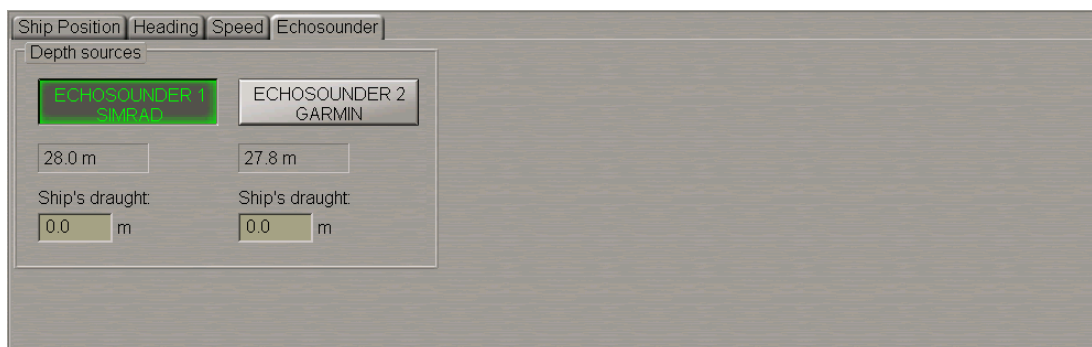

Echosounder page is designed for selection of depth source. **Echosounder** page shows all the connected depth sensors.

The group of each depth source can contain the following elements:

- **ECHOSOUNDER 1** – to select this sensor as depth source; the window is intended for display depth value from the sensor;
- **Ship's draught** – to enter ship's draught in the place of echosounder transducer location.

Press the button with the source name to select the main source of depth whose data will henceforth be used for making all the calculations in the system. Enter ship's draught for each echosounder.

Obtaining Current Information about Navigational Data

Press the button with the name of the set display in the **Display Panel** window of the Control panel.

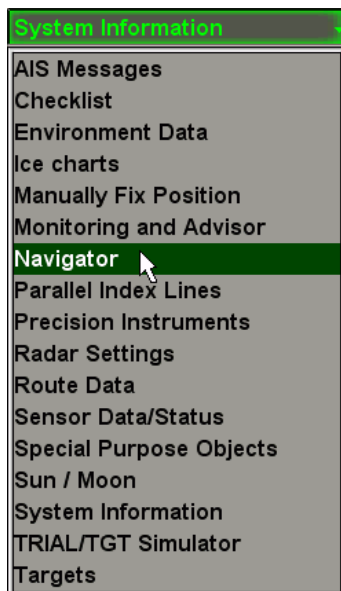

In the list, which will open up, select **Navigator** line and press the left trackball button.

Navigator	
HDG	269.9°
STW	5.0 kn
COG	269.9°
SOG	5.0 kn
ROT	1.0/min PORT
XTD	135 m STBD

Navigator display is intended for enlarged presentation of the following selectable data:

- HDG (Heading);
- STW;
- COG;
- SOG;
- ROT;
- XTD;
- BWOL (Bearing to Wheel Over Line);
- BWW (Bearing Waypoint to Waypoint);

- DWOL (Distance to Wheel Over Line);
- ETA;
- TTG (Time To Go);
- Radius (turn radius at the next waypoint);
- Turn Radius.

Only six values could be displayed simultaneously at the display.

Press the button in the left-hand part of the display and from the pull-down list, select navigational data which is required to be shown on the display.

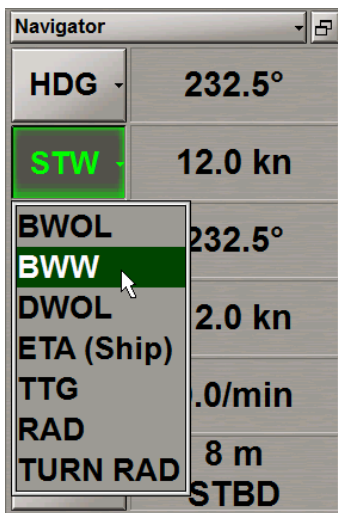

Make up the **Navigator** display configuration which suits you best.

To display depth from the echosounder on the ECDIS task screen, press the button with the name of the set display in the **Display Panel** window of the Control panel.

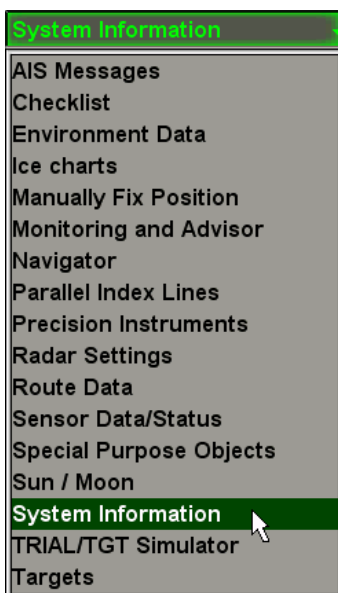

In the list, which will open up, select **System Information** line and press the left trackball button.

System Information	
Drift	135.0° - 0.0 kn
Current	354.0° - 0.0 kn
SF CNT	50 m
True wind	119.9° - 10.0 m/s
Rel. wind	075.7°(P) - 9.5 m/s
Water t°	18.0 °C
Depth	28.0 m
ECHOSOUNDER 1	
Tide height	
5.1 m	Sandettie Bank

In **Depth** row it is displayed value of water depth under the keel (from the sounder data).

Loading of Route and Schedule in the Navigation Mode



Attention! Loading of route and schedule in the navigation mode is available only at station with the status MASTER.

Setting Lead Distance (F-dist)



Attention! For the F-dist setting no route should be loaded in the monitoring mode.

Open **Config** panel by selecting the appropriate line of **Tasks List** menu in the tabs zone of the ECDIS task screen.

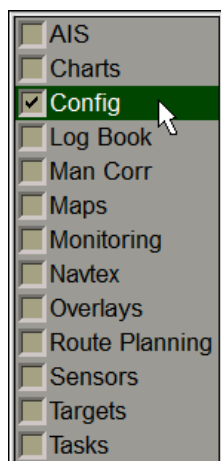

Use the tab in the top part of **Config** panel which will open up, to switch to **General** page:

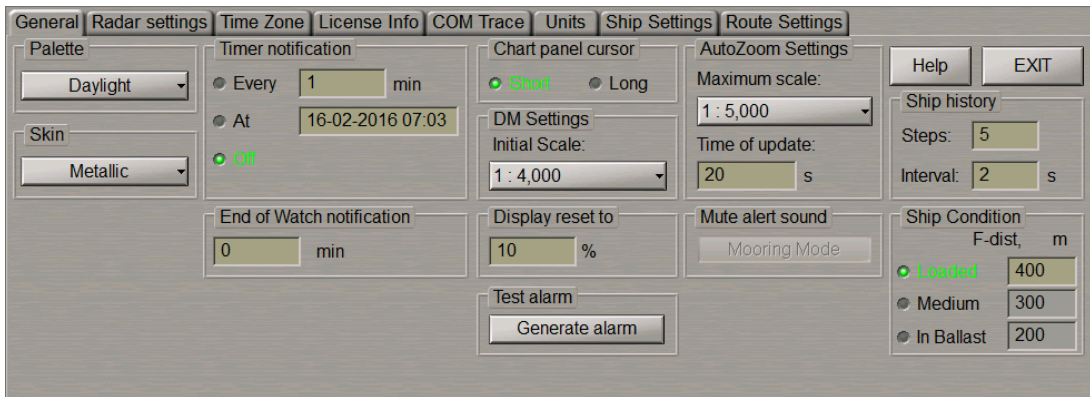

Note: The lead distance (F-dist) is set during the installation on the **Ship Settings** page of the **INS** panel (see document *Multi-Functional Display (v. 3.00.340). Installation Guide Part 1, Chapter 2, section MFD Configuration, paragraph MFD Settings*).

In **Ship Condition** group, select ship loading conditions.

Note: If the monitored route is selected or the WS is not the Navigation MASTER, the group will be greyed.

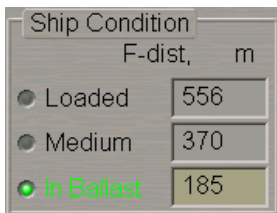

In the input to the right, set the F-dist. The selected distance will be taken into account in the operation of various functions throughout the MFD (e.g., route planning, Curved Heading Line, Track Control etc.).

Loading Route

Open **Monitoring** panel by selecting the appropriate line of **Tasks List** menu in the tabs zone of the ECDIS task screen.

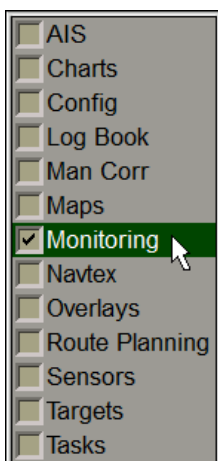

Use the tab in the top part of **Monitoring** panel, which will open up, to switch to **Route Monitoring** page:

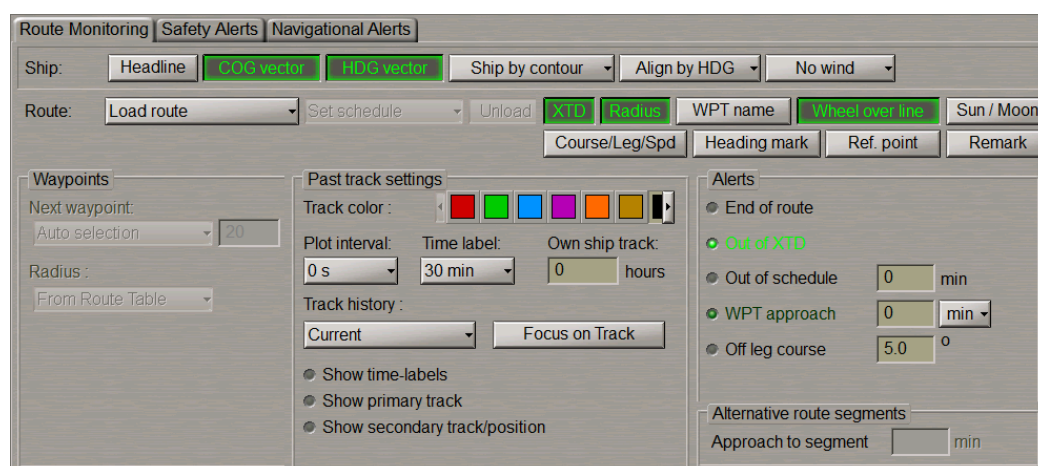

Route group enables loading and unloading of monitored routes and schedule by using the following buttons:

- **Load route** – to select and load a route from the offered list;
- **Set schedule** – to select and load a schedule for the loaded route from the offered list;
- **Unload** – to unload the previously loaded route and/or schedule.



Press **Load route** button in **Route** row of buttons.

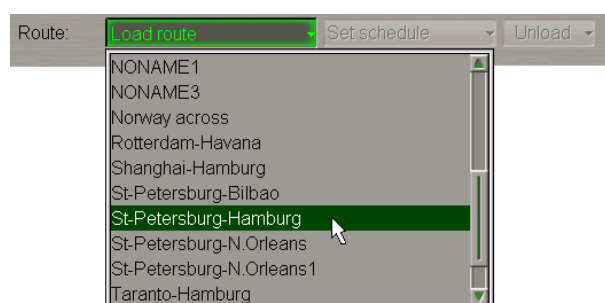

Select the required route and press left trackball button. The selected route will be loaded for sailing in the Chart panel, and its name will be displayed on the button. The route loaded for sailing will be shown in red colour.

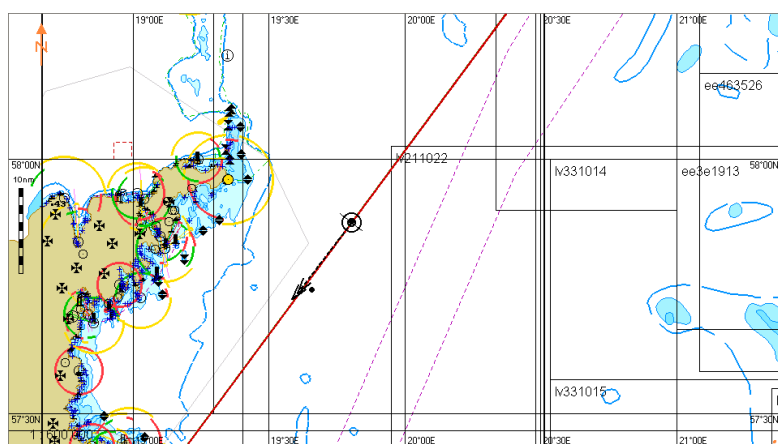

Waypoints group contains buttons and windows for the input values used for calculating mutual positions of the route elements and the ship:

- **Next Waypoint** – to select the mode of setting the next WPT for calculating parameters of motion along the route:
 - **Auto selection** – to switch WPT's successively in the automatic mode; the WPT closest to the ship position is selected automatically;
 - **Manual selection** – to set the next WPT number manually; input of the next WPT number is made in the appropriate window.
- **Radius** – to set parameters of the turn radius arc for the display of an approximate track on the turn on another route leg:
 - **Same for All WPT's** – to set manually for all the route points in the window to the right;
 - **From Route Table** – to set automatically from the data entered in the route.

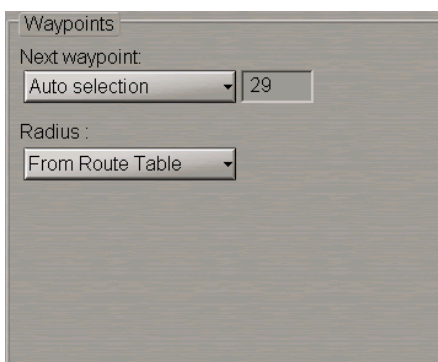

For the manual setting of the next WPT, press **Next Waypoint** button.

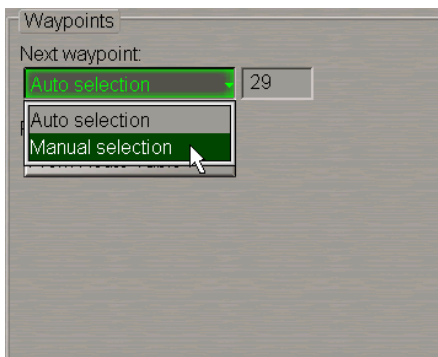

In the list, which will open up, select **Manual selection** and press the left trackball button. Use the activated input line to enter the next WPT number.

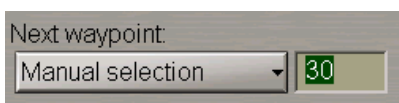

Press the left trackball button.



Attention! In the automatic mode, it is the next WPT of the route leg which the ship is proceeding by which is set. If some other WPT is selected manually for the next one, all the calculations are made relative to the route leg adjacent to the selected WPT.

For the manual setting of the turn arc parameters, press **Radius** button.

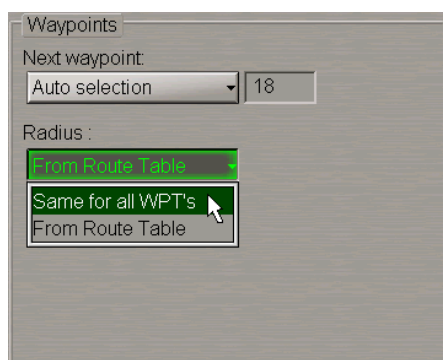

In the list, which will open up, select **Same for all WPT's** and press the left trackball button. Use the activated left-hand input line to enter a new turn arc radius.

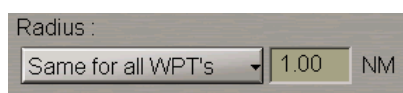

Press the left trackball button. The set parameters will be fixed for all the points of the monitored route.

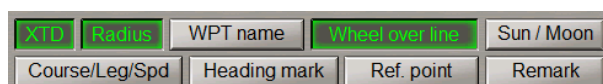

To turn on the display on the ECDIS task screen monitoring route elements, press following buttons:

- **XTD** – to display deviation from the route line (set during the route generation see *Chapter 9*, section *Creating a Route*);
- **Radius** – to display set turn radius arc on the turn to another route leg;
- **WPT names** – to display the names of waypoints set in the route plan;
- **Wheel over lines** – to display Wheel Over Lines;
- **Sun/Moon** - to display sun and moon rises and sets symbols;
- **Course/Leg/Spd** – to display course, range and speed for each route leg;
- **Ref. points** – to display Reference points. The Reference points are entered at the route planning and editing stage on the **Route Planning** panel (see *Chapter 9*, section *Voyage Plan Creation*, paragraph *Obtaining Information on Sun/Moon on the Route*);
- **Heading mark** – to display dashed lines stretching the current and next legs of the monitored route in both directions to the limits of the ECDIS task screen;
- **Remark** – to display additional important remarks in plain text for every route leg. The route leg remarks are entered at the route planning and editing stage on the **Route Planning** panel (see *Chapter 9*, section *Work with Route*, paragraph *Creating a Route*, item *Entering Additional Data*).

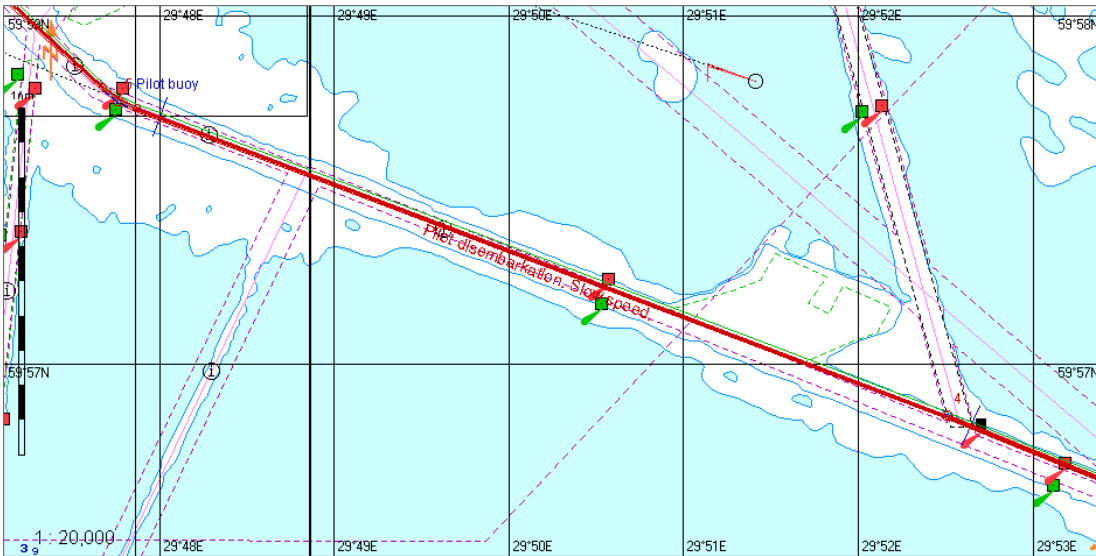

Selection of Safety Parameters when Loading Monitored Route

Open **Monitoring** panel by selecting the appropriate line of **Tasks List** menu in the tabs zone of the ECDIS task screen.

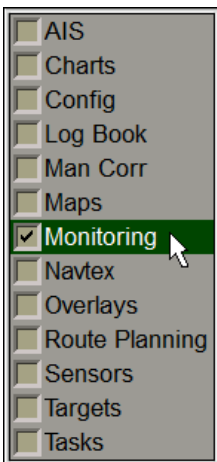

Use the tab in the top part of **Monitoring** panel, which will open up, to switch to **Safety Alerts** page.

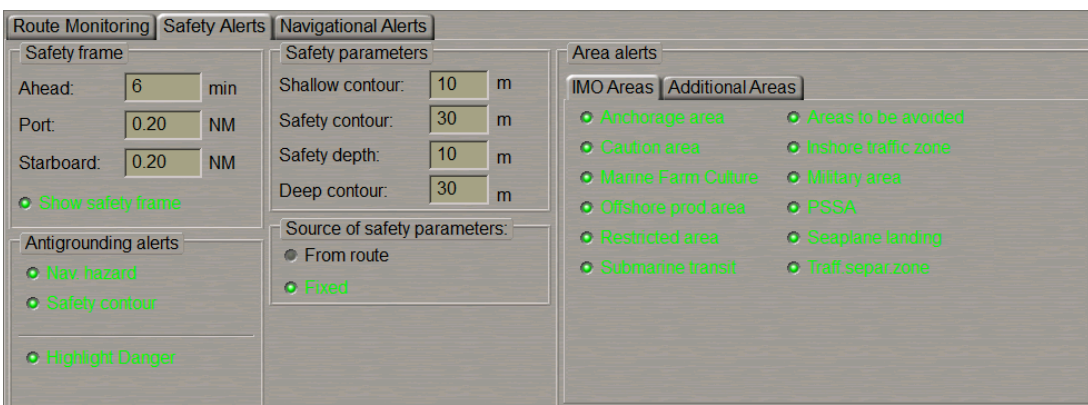

In the **Source of safety parameters** group, select the source which the safety parameters will be taken from for the route monitoring.

If the route is not loaded for monitoring, the **Fixed** radio button will be selected automatically, safety parameters set in the **Safety parameters** group are used for monitoring dangers.

As a route to be monitored is loaded, the last operator-selected **From route** or **Fixed** value is set automatically.

If the **Fixed** value is selected, the safety parameters set in the **Safety parameters** group are used (see also document *Multi-Functional Display (v. 3.00.340). Functional Description, Chapter 4, section Main Alerts Generation Principles*, paragraph *Safety Alerts*).

If the **From the route** value is selected, safety parameters are selected by using the procedure detailed below.

Depending on the sailing area (narrows or open sea), when creating the route, the user can specify appropriate safety parameters (safety contour, safety depth) for each leg. As the ship is proceeding along the route, should the current values of safety parameters differ from the values set on the route, the ECDIS will automatically offer to apply new safety parameters (with the Advanced Planning option ON). When a monitored route is loaded, there may be two scenarios depending on the ship position relative to the route at the moment of loading:

1. The ship is approaching the start of the route, i.e., it is WPT "0" which will be monitored after loading.

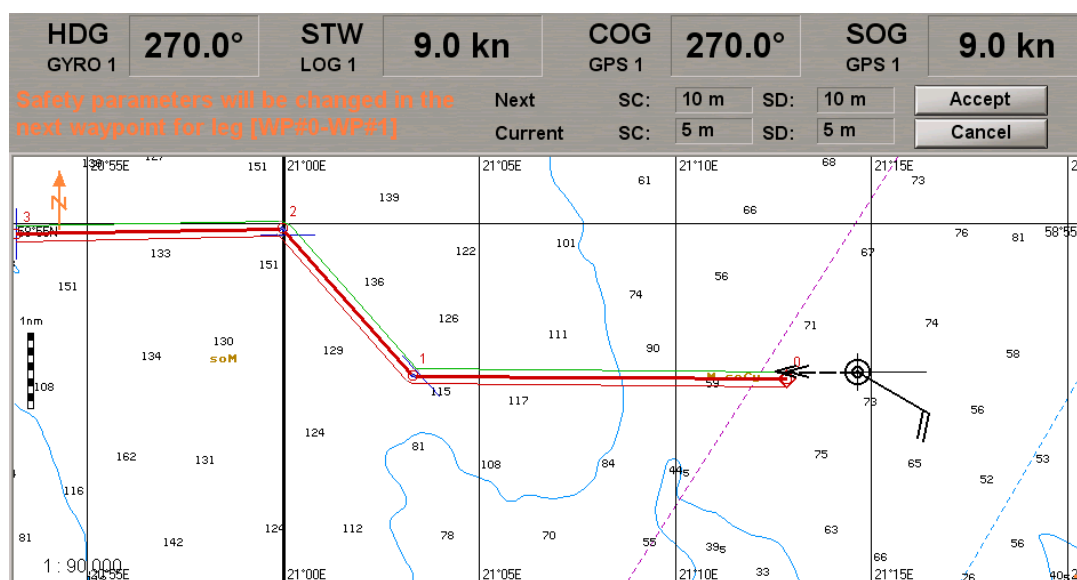

If the safety contour (SC) and safety depth (SD) values in the loaded route match the current values (set on the **Safety Alerts** page of the **Monitoring** panel), no warnings will be displayed. If the values of safety parameters differ from the current values, the top part of the Chart panel will display a warning in which the user will be requested to apply the values specified in the route for the WPT0-WPT1 leg by pressing the **Accept** button, or leave the current safety parameters by pressing the **Cancel** button. New safety parameters will be applied (i.e., they will become the current values and will be displayed on the **Safety Alerts** page of the **Monitoring** panel) after WPT 0 has been passed. If the operator ignores the warning, larger SC and SD values will be set with a change of the waypoint.

2. The ship is on some leg of the route which is being loaded, on the WPT0-WPT1 leg in the example below.

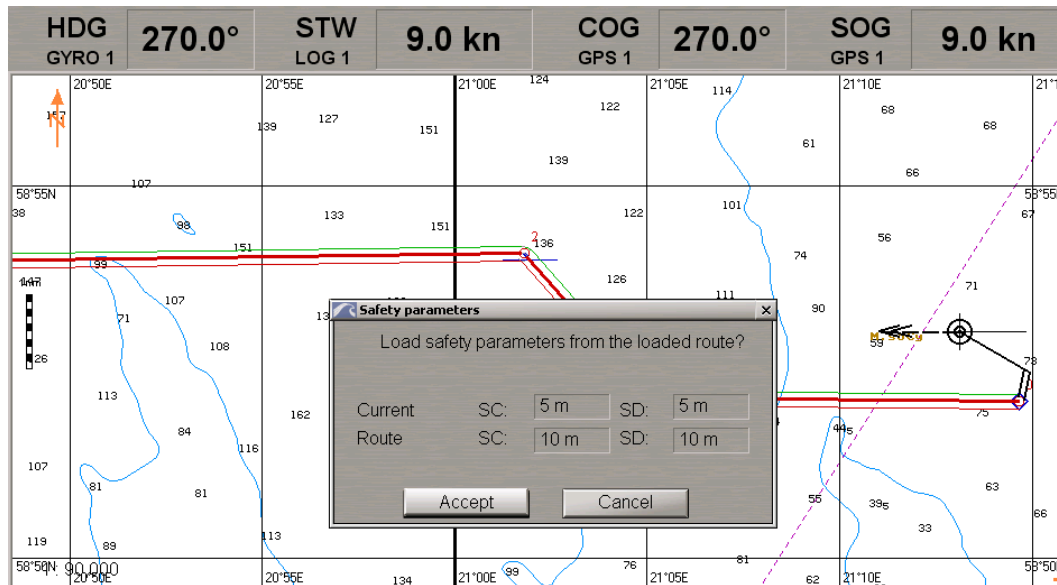

If the safety contour (SC) and safety depth (SD) values for the current leg of the route which is being loaded match the current values, no warnings are displayed. Otherwise the Chart panel will display the **Safety Parameters** pop-up window. This window specifies the current SC and SD values as well as the values set for the current route leg (WPT0-WPT1). The user should select values which should be loaded for monitoring: from the route (**Accept** button) or leave the current values (**Cancel** button). If new safety parameters are applied for the current route leg, they will immediately become the current values and will be displayed on the **Safety Alerts** page of the **Monitoring** panel).

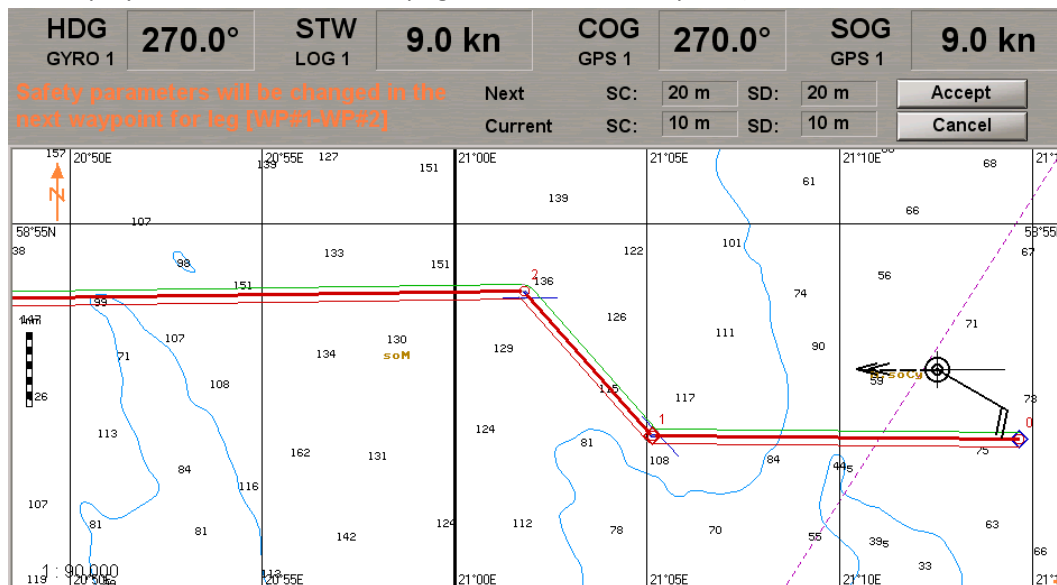

After this, if the SC and SD values for the current leg (WPT0-WPT1) do not match the values set for the next route leg (WPT1-WPT2), the top part of the Chart panel will display a relevant warning (for further information see item 1).

As the ship is proceeding along the monitored route, if the SC and SD values of the next leg are different from the current value, 2 minutes after the waypoint (WPT1) is changed, an appropriate warning will appear in the top part of the Chart panel (for leg WPT2-WPT3).

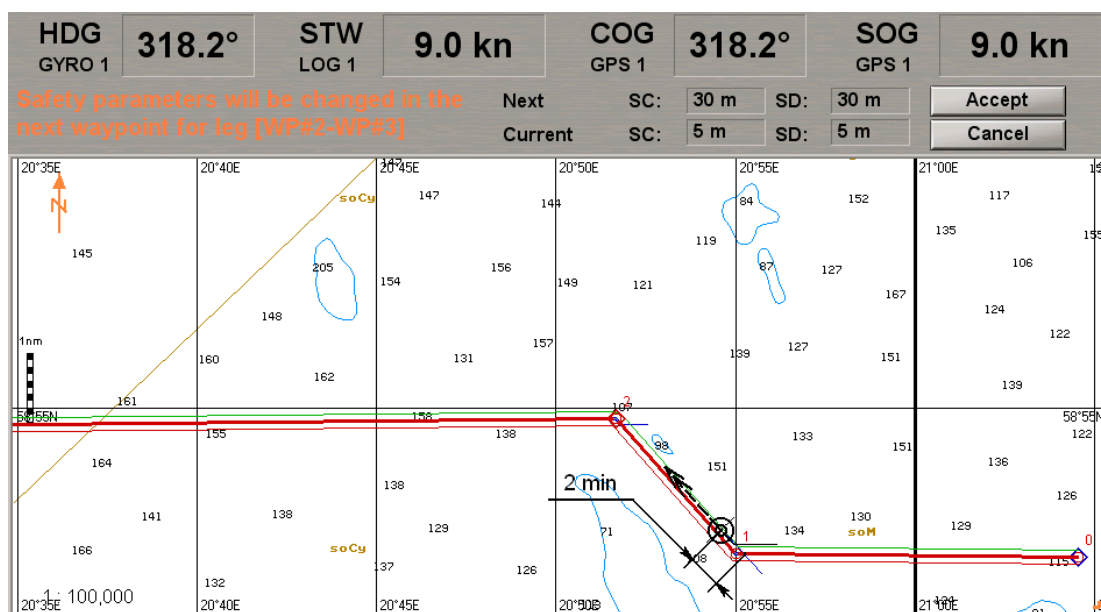

The user is then required to use the procedure described in item 1.

Loading Schedule

Open **Monitoring** panel by selecting the appropriate line of **Tasks List** menu in the tabs zone of the ECDIS task screen.



Use the tab in the top part of **Monitoring** panel, which will open up, to switch to **Route Monitoring** page.



Route group enables loading and unloading of monitored routes and a schedule by using the following buttons:

- **Load route** – to select and load a route from the offered list;
- **Set schedule** – to select and load a schedule for the loaded route from the offered list;
- **Unload** – to unload the previously loaded route and/or schedule.



Press **Load route** button in **Route** row of buttons.

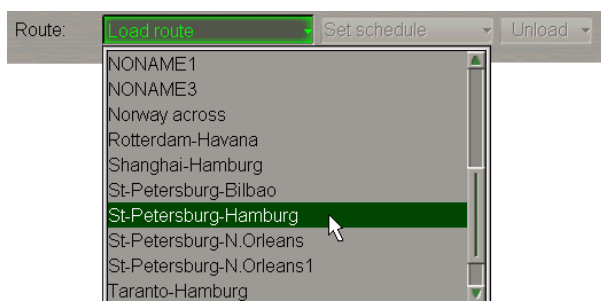

Select the required route and press the left trackball button. The selected route will be loaded for sailing on the Chart panel, and its name will be shown on the button.

Press **Set schedule** button in **Route** row of buttons.

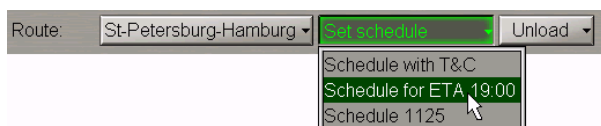

The list of schedules created for this route will open up. Select the necessary schedule. Press the left trackball button. The selected schedule will be loaded.

Obtaining Current Information about Monitoring Route and Schedule

Route Data

Press the button with the name of the set display in the **Display Panel** window of the Control panel.

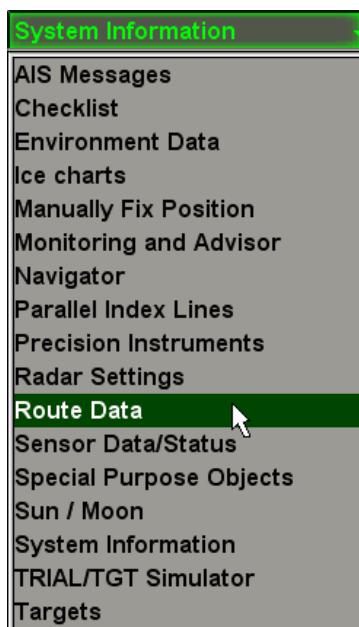

In the list, which will open up, select **Route Data** line and press the left trackball button.

Use the tab in the top part of the **Route Data** display which will open up, to switch to the **Route Data** page.

Route Data	
Route Data	Schedule RDV
Route	St-Petersburg-Hamburg
To WPT 20	
BWW	216.5°
XTD	8 m - STBD
BWOL	216.5°
DWOL	168.51 NM
ETA (UTC)	09-12-15 05:15:32
TTG	0 d 14 h 02 m
Next WPT 21	
BWW	232.5°
RAD	0.50 NM

Route Data page is intended for the display of data as the ship is proceeding along the route to the next waypoint (see document *Multi-Functional Display (v. 3.00.340). Functional Description, Chapter 5, section Route Monitoring*, paragraph *Sailing Along the Route*).

The page contains the following data:

- **Route** – name of the monitored route; as **End of route** warning is generated, the word “Route” is shown in the orange colour;
- **To WPT** – number and name of the current WPT which the ship is proceeding to; the WPT name is shown in black colour if the WPT is selected automatically, and in the blue colour if selected manually;
- **BWW** – direction of the monitored route leg which the ship is proceeding by if the leg is of RL type; or the current course in case of the GC leg;
- **XTD** – actual distance from the current route leg; as **Off track** alarm is generated, the letters “XTD” are shown in orange colour;
- **BWOL** – bearing to the current WOL;
- **DWOL** – distance to the current WOL;
- **ETA** – the estimated time (UTC/Ship depending on the setting made in the Control panel) of arrival in the current WPT, the remaining distance and current speed (SOG) taken into account;
- **TTG** – time to go to the current waypoint calculated with regard to the actual speed (SOG);
- **Next WPT** – number of the next WPT;
- **BWW** – direction of the next route leg;
- **RAD** – radius arc on the turn to the next route leg.

Schedule Information

Press the button with the name of the set display in the **Display Panel** window of the Control panel.

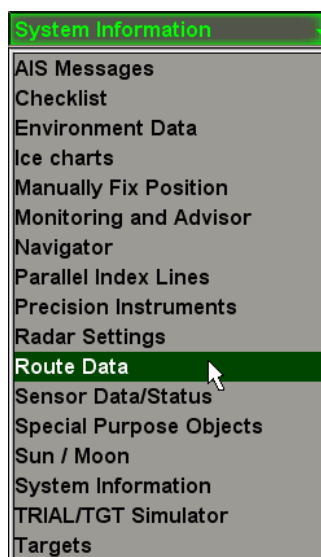

In the list, which will open up, select **Route Data** line and press the left trackball button.

Use the tab in the top part of the **Route Data** panel which will open up, to switch to the **Schedule** page.

Route Data	
Route Data Schedule RDV	
To WPT:	20
Schedule Current SOG	
ETA (UTC)	09-12-2015 05:15:32
TTG	0 d 14 h 00 m
DWOL	168.1 NM
PTA (00:00)	09-12-2015 05:45:27
Quick calculation	
STG (kn)	PTA (Ship time)
8.0	12-12-15 00:28
12.0	09-12-15 12:21

Schedule page serves for presenting information connected with sailing according to the selected schedule (see document *Multi-Functional Display (v. 3.00.340). Functional Description, Chapter 5, section Route Monitoring, paragraph Sailing Along the Route*). For the display of data, it is necessary to load a route on **Route Monitoring** page of **Monitoring** panel (see above *Loading Route*). The schedule elements whose values differ from those set on **Route Monitoring** page of **Monitoring** panel (**Out of Schedule** alert) are shown in orange colour.

The display contains the following data:

- **To WPT** – to select a WPT number for the display of associated schedule elements; the line to the right shows the name of the WPT if any was given by the operator;
- **Schedule** – to turn on the display of ETA and TTG calculated with regard to the prepared schedule;
- **Current SOG** – to turn on the display of ETA and TTG calculated with regard to the current speed (SOG);
- **ETA (UTC)** – estimated time of arrival in the selected WPT calculated from the remaining distance and set speed (UTC/Ship depending on the setting made in the Control panel);
- **TTG** – time to go to the specified WPT calculated with regard to the actual ETA;
- **DWOL** – distance to to wheel over line;
- **PTA** – planned time of arrival in the specified WPT taken from the schedule.

In the bottom part of the display there is a calculator for calculating speed to go (STG) to the specified waypoint or planned time of arrival (PTA) in the specified waypoint:

- **STG** – operator-entered planned speed of proceeding to the specified point for the PTA calculations in the window on the right;
- **PTA** – operator-entered planned time of arrival (PTA) to the specified point for the STG calculations in the window on the left.

Unloading Route and Schedule

Open **Monitoring** panel by selecting the appropriate line of **Tasks List** menu in the tabs zone of the ECDIS task screen.

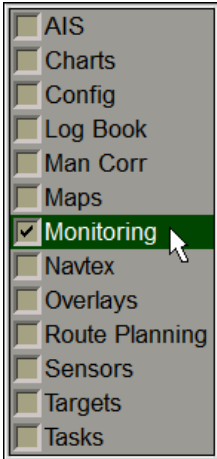

Use the tab in the top part of **Monitoring** panel, which will open up, to switch to **Route Monitoring** page.

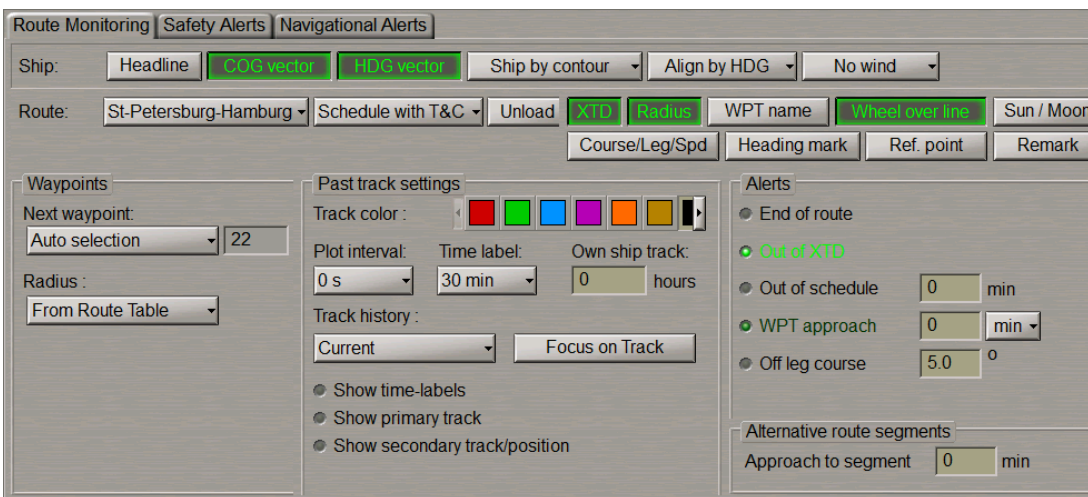

In **Route** group press **Unload** button. The route and/or schedule loaded for sailing will be unloaded.

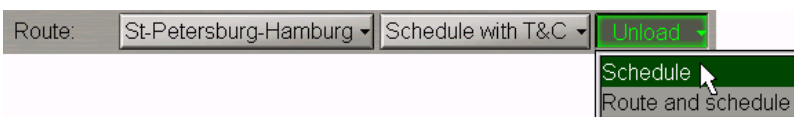

Handling Charts and Chart Information

Prompt Search and Load Charts

Open **Charts** panel by selecting the appropriate line of **Tasks List** menu in the tabs zone of the ECDIS task screen.

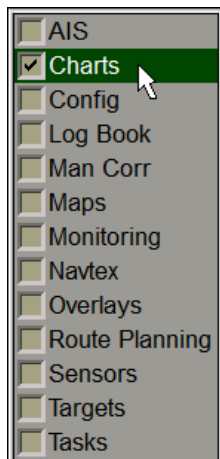

Use the tab in the left part of **Charts** panel, which will open up, to switch to **Complete list** or **By position** page depending on which chart is required to be found. All the functions of these pages are identical, the only difference between them being in the set of charts available for work.

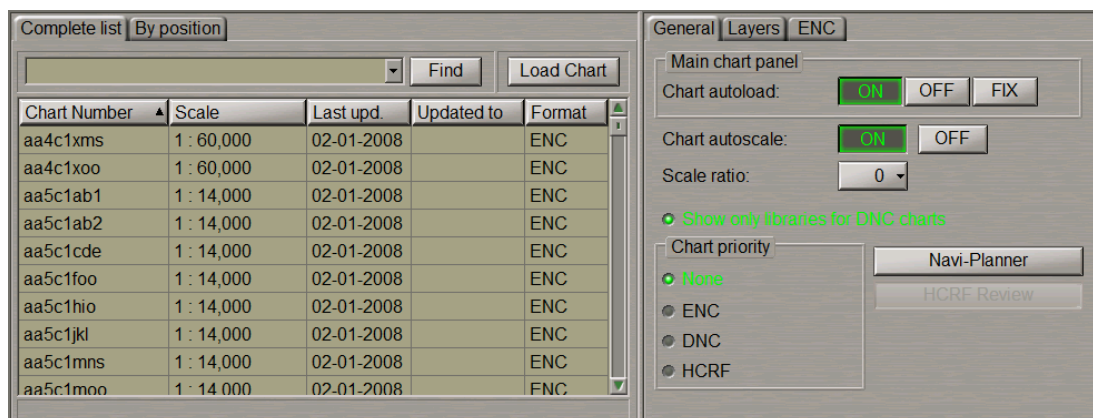

The aforementioned pages contain the following:

- Chart number input window and **Find** button activate the chart search function by the number entered in the window.
- If the chart with the required number has not been found, the prompt bar in the bottom part of the area displays the following message:
 - **No charts found** – no charts with this number have been found;
 - **Partial match found** – a group of charts has been found, whose numbers start with the entered characters.

- Manual chart selection window. Charts in the list can be sorted by the following parameters:
 - **Chart Number** – chart number;
 - **Scale** – chart scale;
 - **Last upd.** – date of the most recent chart updating in dd-mm-yyyy format;
 - **Updated to** – the media, which was used for the latest updating of TX-97 or SENC chart collection;
 - **Format** – chart format.

Type the number or the first characters of a chart from the ship folio in the input field, and press **Find** button.



Complete list

Chart Number ▲	Scale	Last upd.	Updated to	Format ▲
lv512101	1 : 10,000	08-07-2011	WK21-12	TRS
lv513700	1 : 7,500	08-01-2012	WK21-12	TRS
lv532100	1 : 8,000	10-10-2011	WK21-12	TRS
lv532102	1 : 8,000	08-01-2012	WK21-12	TRS
lv532103	1 : 8,000	17-09-2011	WK21-12	TRS
lv613215	1 : 2,000	08-05-2009	WK21-12	TRS
lv613250	1 : 2,000	10-10-2011	WK21-12	TRS
lv613504	1 : 5,000	10-12-2009	WK21-12	TRS
nl110	1 : 75,000	19-01-2012	WK08-12	TRS
nl110a	1 : 40,000	19-01-2012	WK08-12	TRS

The necessary chart will be highlighted in the table. Press **Load Chart** button, the selected chart will be loaded in the Chart panel.

Loading and Scaling Charts under Own Ship Position

Open **Charts** panel by selecting the appropriate line of **Tasks List** menu in the tabs zone of the ECDIS task screen.

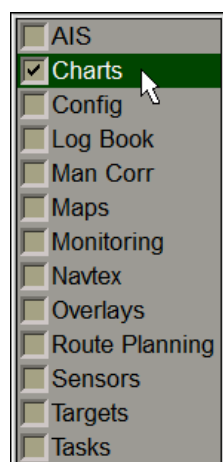

Use the tab in the right-hand part of **Charts** panel, which will open up, to switch to **General** page.

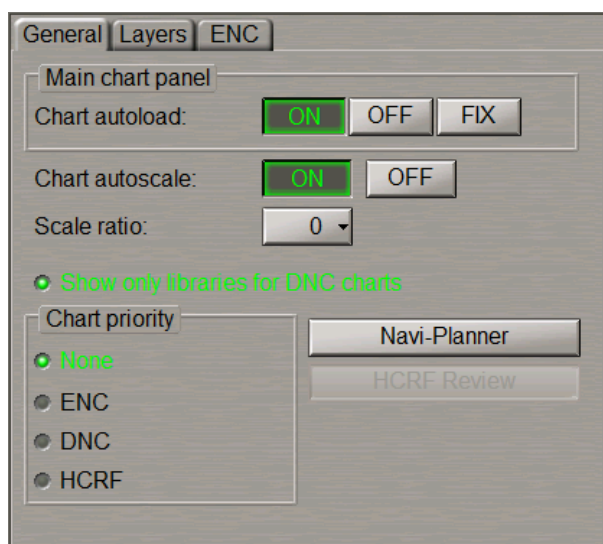

This page is intended for the control of chart automatic loading and scaling which are determined by the following parameters:

- **Chart autoloading** – chart loading modes switching buttons:
 - **ON** – to turn on the chart autoloading mode whereby the largest scale chart will be automatically loaded;
 - **OFF** – to turn off the autoloading mode; as this is done, the current chart under the ship position or the chart loaded manually is fixed until the loading mode switch;
 - **FIX** – to turn on the chart fixing mode; as the ship symbol crosses the boundary of such chart, the chart loading mode is automatically switched to ON position.
- **Chart autoscaling** – chart scaling modes switching buttons:
 - **ON** – to load the chart on its original scale;
 - **OFF** – to load the chart on the screen current scale.
- **Scale ratio** – to set the loaded chart scale differing from its original scale by the number of fixed scale values (± 5);
- **Show only libraries for DNC charts** – to enable displaying of DNC library name instead of DNC tiles names (if DNC charts used);
- **Chart priority** – to set the chart loading priority under the ship position:
 - **None** – to load charts most suitable to the set scale. In this case, if there are several charts on the same scale, priority is given to the TX-97 (TRX) format charts;
 - **ENC** – to load ENC format vector charts;
 - **DNC** – to load DENC format vector charts;
 - **HCRF** – to load ARCS and Seafarer format raster charts (RCDS mode, see also document *Multi-Functional Display (v. 3.00.340). Functional Description, Chapter 4, section Indications*, paragraph *Display of Important Indications*);
- **Navi-Planner** – to open the Navi-Planner 4000 application;
- **HCRF Review** – to open the window for viewing ARCS and Seafarer format charts.

Chart Loading

To turn on chart autoloading:

1. Press **ON** button in **Chart autoload** row of buttons (if not depressed).



2. Press **Autoload** button in the **Charts Area** window of the Control panel.



This window is designed for the adjustment of the chart display on the Chart panel:

- **Chart number** – to call a menu with a list of charts under the ship position (if the ship symbol is displayed on the chart) or the list of all the charts available in the ship folio. The button shows the current chart number;
- **Autoload** – to turn on the function for the automatic loading of charts. There is an indicator to the right of the button:

ON – the function is turned on (**Autoload** button is greyed);

OFF – the function is turned off;

FIX – to fix the current chart.

The chart autoloading mode is set. To manual loading of the required chart, press **OFF** button in **Chart autoload** row of buttons (if not depressed).

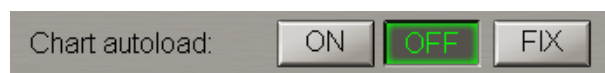

The chart autoloading mode is OFF, and the screen displays the current chart only.

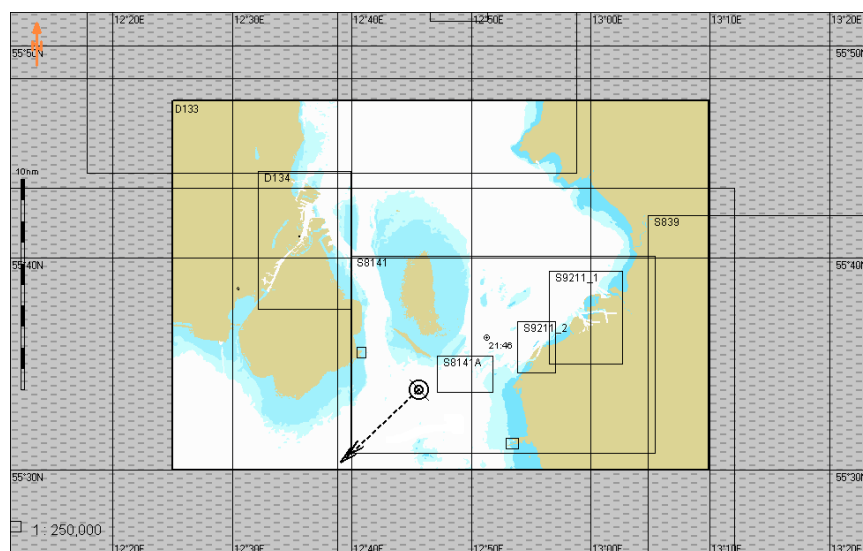

In the **Charts Area** window of the Control panel, press button with the current chart number.



Select the necessary chart from the list. The ECDIS task screen will display the required chart.

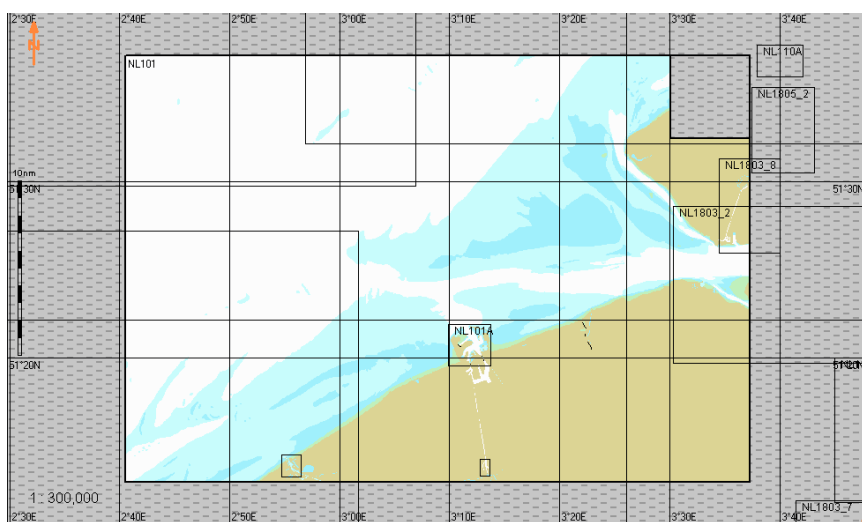

Selecting Loading Priority of Various Format Charts

Where ARCS and Seafarer format charts are available in the ship folio, you can set their loading priority. In **Chart priority** group check **HCRF** checkbox to set the loading priority for charts of ARCS and Seafarer formats.

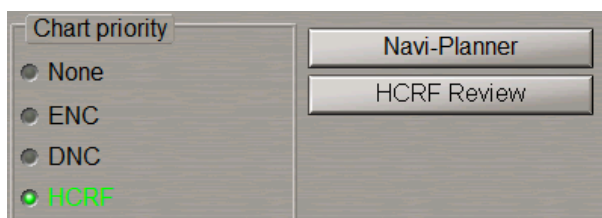

Note: The checking of this checkbox turns on the RCDS (Raster Chart Display System) mode. In this case, the Chart panel starts displaying important indications related to this mode (see also document *Multi-Functional Display (v. 3.00.340). Functional Description, Chapter 4, section Indications, paragraph Display of Important Indications*).

To view ARCS and Seafarer format charts, press **HCRF Review** button or  button on the Chart panel toolbar. The chart is displayed in the window, which opens up.

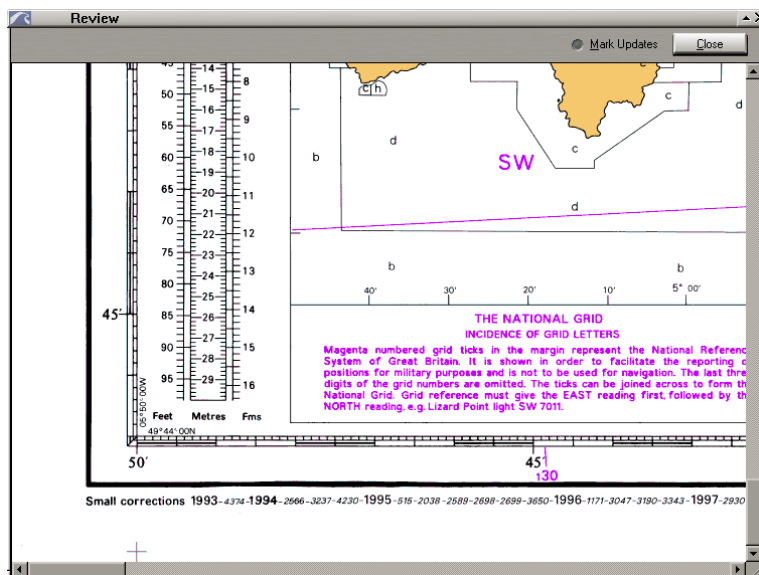

To display the updating which may have been done, check **Mark Updates** checkbox.

If necessary to set loading priority of ENC format charts, check **ENC** checkbox.

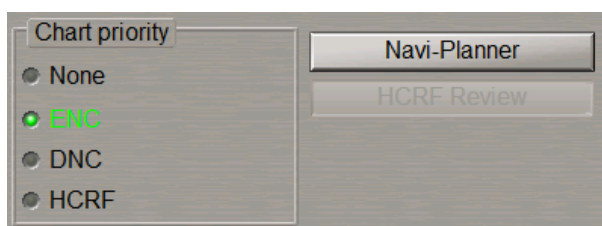

If necessary to set loading priority of DNC format charts, check **DNC** checkbox.

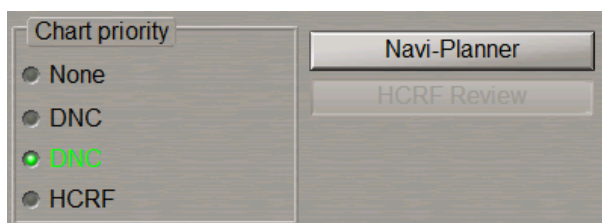

Chart Scaling

To automatic scaling, press **ON** button in **Chart autoloading** row of buttons (if not depressed).



Press **ON** button in **Chart autoscale** row of buttons (if not depressed).



If it is necessary to turn on manual change of scale in the transfer to the next chart, use **Scale ratio** window to set the number of fixed values (from 1 to 5), which the scale should be increased/decreased by.

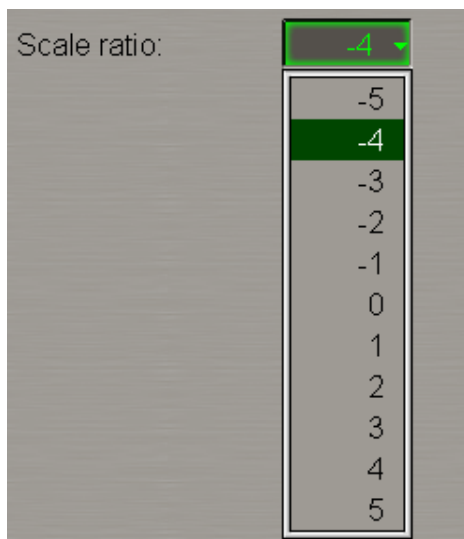

To manual scaling, press **OFF** button in **Chart autoscale** row of buttons.

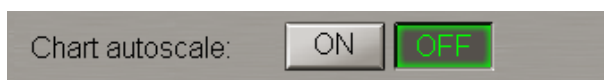

Press scale button in **Chart Area** window on the Control panel (the button shows the current screen scale).

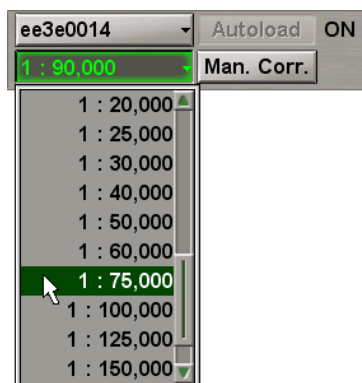



Select the required scale from the list, which will open up, and press the left trackball button. The ECDIS task graphic screen will display all the charts on the set scale.

There are two ways to decrease the chart display scale by the fixed scale value:

- Press  button on the Chart panel toolbar;
- Press <ZOOM OUT> key on the ES6 keyboard.

There are two ways to increase the chart display scale by the fixed scale value:

- Press  button on the Chart panel toolbar;
- Press <ZOOM IN> key on the ES6 keyboard.

To display the chart on the original scale, press  button on the Chart panel toolbar.

Switching Chart Information Layers

Open **Charts** panel by selecting the appropriate line of **Tasks List** menu in the tabs zone of the ECDIS task screen.

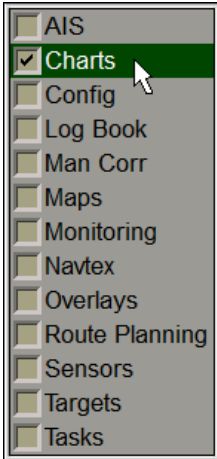

Use the tab in the right-hand part of **Charts** panel, which will open up, to switch to **Layers** page.

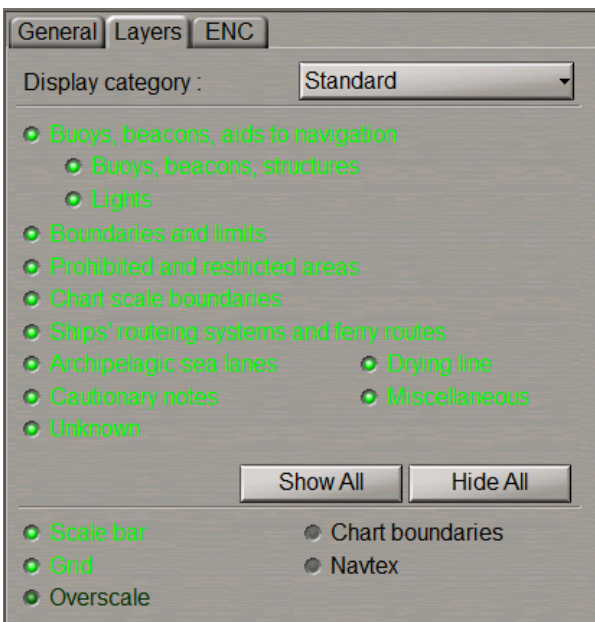

This page is intended for controlling the display of individual chart information classes by using the following controls:

- **Display category** – to switch presentations of different display types:
 - **Base** – to turn on presentation of objects included in the Base Display;
 - **Standard** – to turn on presentation of objects included in the Standard Display;
 - **Custom** – to turn on presentation of objects included in the Additional Information Display at the user discretion;
 - **All** – to turn on presentation of all the objects included in the Additional Information Display.

According to the IEC 61174 standard the following information, has to be displayed during planning of a route and monitoring of a route:

- Display Base to be permanently shown on the ECDIS display, consisting of:
 - Coastline (high water);
 - Own ship's safety contour;
 - Isolated underwater dangers of depths less than the safety contour which lie within
 - Safe waters defined by the safety contour;
 - Isolated dangers above water which lie within the safe water defined by the safety
 - Contour such as fixed structures, overhead wires, etc;
 - Scale, range and north arrow;
 - Units of depth and height; and
 - Display mode.
- Standard Display, consisting of:
 - Display base;
 - Drying line;
 - Buoys, beacons, other aids to navigation and fixed structures;
 - Boundaries of fairways, channels, etc.;
 - Visual and radar conspicuous features;
 - Prohibited and restricted areas;
 - Chart scale boundaries;
 - Indication of cautionary notes;
 - Ship's routing systems and ferry routes;
 - Archipelagic sea lanes.
- All other information, to be displayed individually on demand, for example:
 - Spot soundings;
 - Submarine cables and pipelines;
 - Details of all isolated dangers;
 - Details of aids to navigation;
 - Contents of cautionary notes;
 - ENC edition date;
 - Most recent chart update number;
 - Magnetic variation;
 - Graticule;
 - Place names.

Press **Display category** button and select **Standard** menu item from the drop-down list:

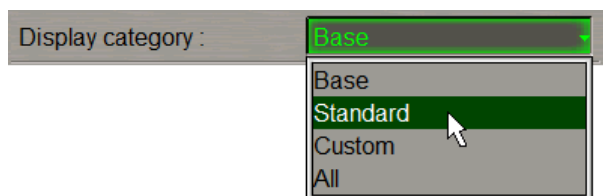

All the checkboxes for turning on the display of the objects included in the display will be checked by default:

- **Buoys, beacons, aids to navigation** – to turn on the display of buoys, beacons, aids to navigation;
- **Boundaries and limits** – to turn on the display of boundaries and limits;
- **Prohibited and restricted areas** – to turn on the display of prohibited and restricted areas;
- **Ships' routeing systems and ferry routes** – to turn on the display of ships' routeing systems and ferry routes;
- **Archipelagic sea lanes** – to turn on the display of archipelagic sea lanes;
- **Cautionary notes** – to turn on the display of cautionary notes;
- **Drying line** – to turn on the display of drying lines;
- **Miscellaneous** - to turn on display of all not covered objects by **Standard** display;
- **Chart scale boundaries** – to turn on the display of chart scale boundaries;.

Uncheck the appropriate checkboxes to turn off the display of unnecessary chart objects.

Note: If the Standard Display is selected, but some viewing group included in the Standard Display is turned off the **STD DISP is customized** important indication is displayed in the **Operational** window of the Control panel (see also document *Multi-Functional Display (v. 3.00.340). Functional Description, Chapter 4, section Indications, paragraph Display of Important Indications*).

There is another way to set the necessary layer.

The Standard Display can also be set by pressing the  button on the Control panel.

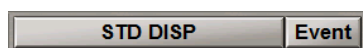

Settings on the **Layers** page and on the Control panel are equalised.

When the Standard Display is set, the display of the radar overlay, ARPA and AIS targets on the ECDIS task screen is automatically turned off.

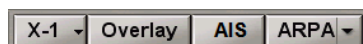

To set displays from the keyboard:

- Press <ALL LAYERS> key on ES6 keyboard to turn on presentation of all the objects included in the Additional Information Display;
- Press the <Standard DISPLAY> key on ES6 keyboard to set the Standard Display.

To turn on the display of the chart over the radar picture, press  button in the Display Panel toolbar. In this case:

- Base Display mode is turned on;
- radar overlay is turned off;
- no targets (AIS, RIB, ARPA) are displayed;
- no tides or currents are displayed;
- no maps objects are displayed;
- no Navtex objects are displayed.

With the use of ES6 keyboard, press the <SHOW CHART> key to activate the function.

Press **Display category** button and select **Custom** menu item from the drop-down list:

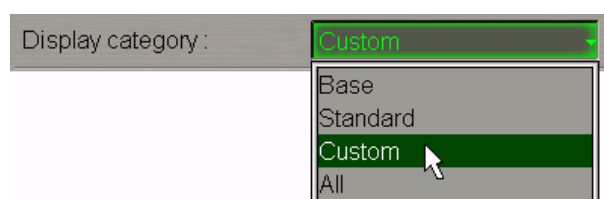

Check the checkboxes for turning on the display of necessary additional chart objects:

- All objects included in the **Standard** display;
- **All Isolated dangers** – to turn on the display of isolated dangers with depths over them larger than the safety depth;
- **Submarine cables, pipelines** – to turn on the display of submerged cables and pipelines;
- **All depth contours** – to turn on the display of all the depth contours;
- **Tidal** - to turn on the display of tidal information;
- **Depth contours** – to turn on the display of depth contours with depths over them larger than the safety depth;
- **Seabed** – to turn on the display of ground characteristics;
- **Important text** – to turn on the display of important text;
- **Other text** – to turn on the display of other text (Names, Light description, etc.);
- **Unknown** - to turn on the display of objects which are not specified in S-52 standard;
- **Miscellaneous STD-** to turn on the display of all not covered objects by **Standard** display;
- **Miscellaneous** - to turn on the display of all not covered objects by **Custom** display;
- **Magnetic variation** – to turn on the magnetic variation;
- **Spot soundings to** – to turn on the display of depth values smaller than the setting made in the relevant window (if the setting is “0”, all the soundings are displayed).

If selected **All** menu item from the **Display category** drop-down list, all the checkboxes for turning on the display of the all available objects will be checked by default.

Handling ENC Format Charts

Open **Charts** panel by selecting the appropriate line of **Tasks List** menu in the tabs zone of the ECDIS task screen.

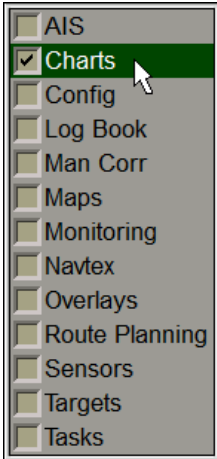

Use the tab in the right-hand part of **Charts** panel, which will open up, to switch to **ENC** page.

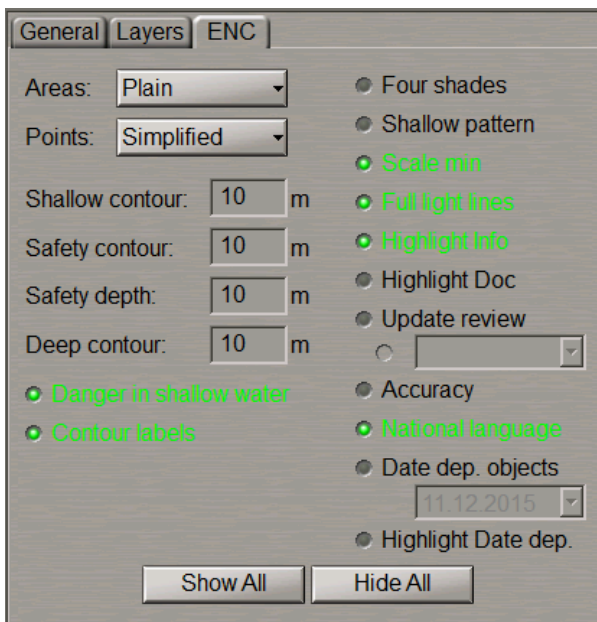

This page is intended for the adjustment of ENC format chart display and handling.

From **Areas** drop-down list, select the style of area type object boundary display (**Plain** and **Symbolised**).

From **Points** drop-down list, select the style of the point type object display (**Paper chart** and **Simplified**).

Check the following checkboxes for turning on the display of necessary additional information classes:

- **Danger in shallow water** - to turn on the display of isolated danger objects which are located in the unsafe waters;
- **Contour labels** - to turn on the display of contour labels;
- **Four shades** – to turn on the colour highlighting of the set depth areas;
- **Shallow pattern** – to turn on the display of hatching in the presentation of areas with depths smaller than the safety contour on ENC format charts;
- **Scale min** – to turn on the display of an object on inadmissible scales to it (generalization method selection);
- **Full light lines** – to switch the lengths of lines delimiting the light visibility sectors;
- **Highlight Info** – to turn on the display of highlighting for objects with “Inform” attribute;
- **Highlight Doc** – to turn on the display of highlighting for objects with “Text and/or Picture” attribute;
- **Update review** – to turn on colour highlighting for the objects which have undergone some modification in the process of the latest accepted correction;
- **Accuracy** – to turn on the display of accuracy symbols for the ship positioning and sounding during seabed contour survey on ENC format charts;
- **National language** – to turn on the display of national language text;
- **Date dep. objects** - to turn on the display of chart objects with temporal attributes;
- **Highlight Dat dep.** – to turn on the display of a symbol that indicates where in the chart display the objects with temporal attributes are located;

If it is necessary, press **Show All** button to turn on the display of all the parameters, or **Hide All** button to turn off them.

The following windows used for information only (these parameters are set on the **Safety Alerts** page of the **Monitoring** panel):

- **Shallow contour** - in the ENC four shades mode defines the value of the shallow contour affecting colours of depth areas (dark blue for depth areas with values shallower than the shallow contour);
- **Safety contour** - mariner-selected contour to distinguish on the display between safe and unsafe water;
- **Safety depth** - mariner-defined depth to emphasize soundings on the display equal to or less than this value;
- **Deep contour** - in the ENC four shades mode defines the value of deep contour affecting colours of depth areas (the lightest S-52 colour for depth areas deeper than the deep contour).

Handling AIO Chart



Attention! For the AIO chart to be displayed, the ENC charts which they are attached to should be installed.

Note: AIO chart is installed by using the Navi-Planner 4000 application.

Open **Overlays** panel by selecting the appropriate line of **Tasks List** menu in the tabs zone of the ECDIS task screen.

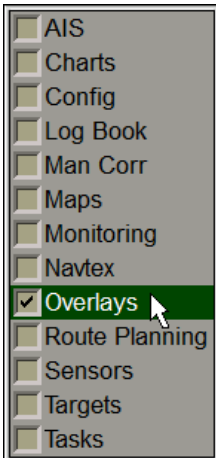

Use the tab in the top part of **Overlays** panel, which will open up, to switch to **AIO Charts** page.

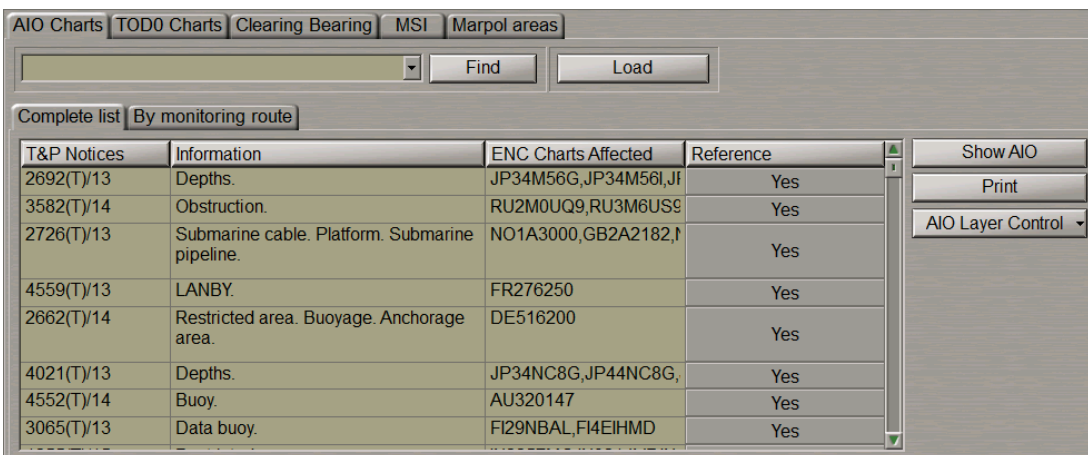

This page is intended for the handling AIO chart available in the ship collection and NTM (Notices To Mariners) included in the AIO chart.

The page contains the following data:

- **Find** – to activate the chart search function by the NTM number entered in the window;
- **Load** – to load chart which the selected NTM in question refers to;
- **Table of NTM**;
- **Show AIO** – to display AIO chart on the Chart panel;
- **Print** - to print selected table rows;
- **AIO Layer Control** - to show separately different object classes and polygon attributes.

Press the **Show AIO** button. The Chart panel will display the AIO layer.

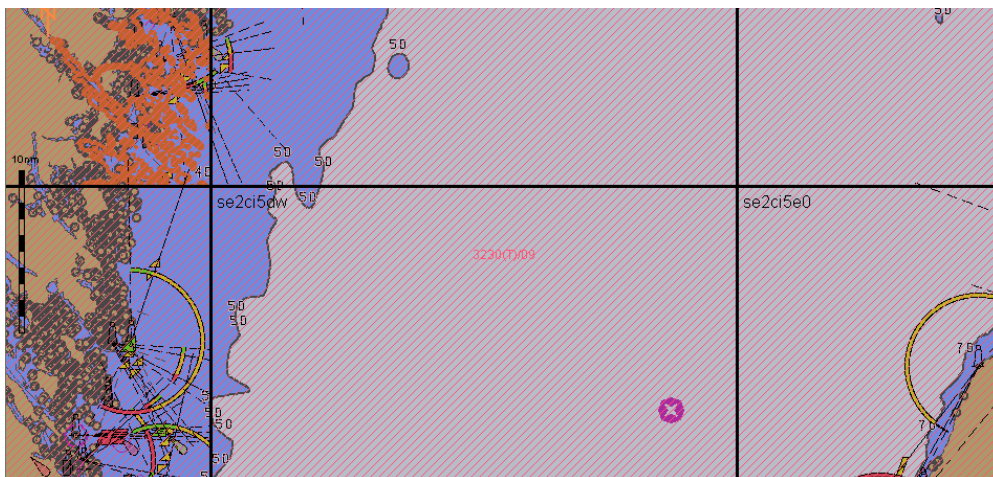

Use the Info function (see *Chapter 11*, section *Obtaining Information on Vector Charts*). On the **Info** panel select the **General Chart Information** notation in **GB80001: S57Ed3_AIO Chart** section by positioning the cursor on it, and press the left trackball button. The page with information on the AIO chart will open up.

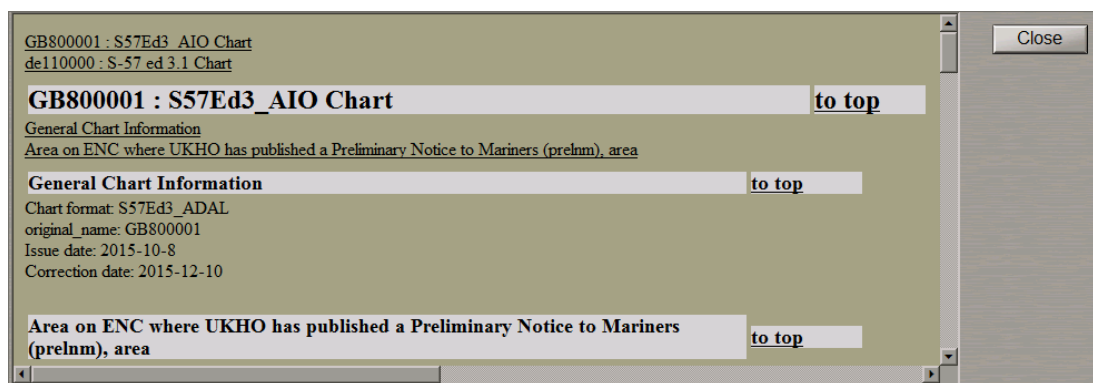

To switch off AIO layer depress the **Show AIO** button .

Use the tab in the left part of **AIO Charts** page, which will open up, to switch to **Complete list** or **By monitoring route** page depending on which NTM is required to be found. All the functions of these pages are identical, the only difference between them being in the set of NTM available for work.

The table which will open up shows the NTM (Notices To Mariners) included in the AIO chart.

The MFD capabilities can be used for reading and printing out the current NTM.

Type the number or the first characters of NTM in the input field, and press **Find** button.

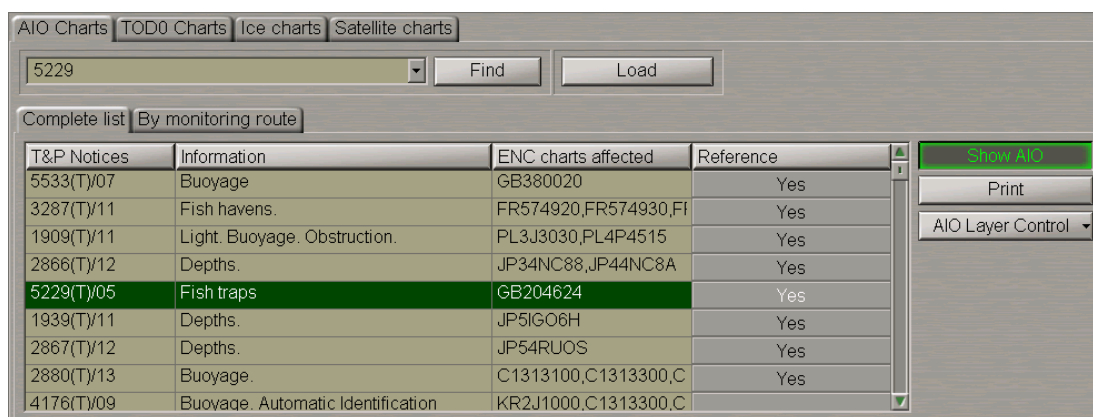

The necessary NTM will be highlighted in the table. The ENC charts affected column lists the chart which the NTM in question refers to.

Double click on this NTM: the Chart panel will display the area which this NTM is applicable to.

Press Yes button in the Reference column.

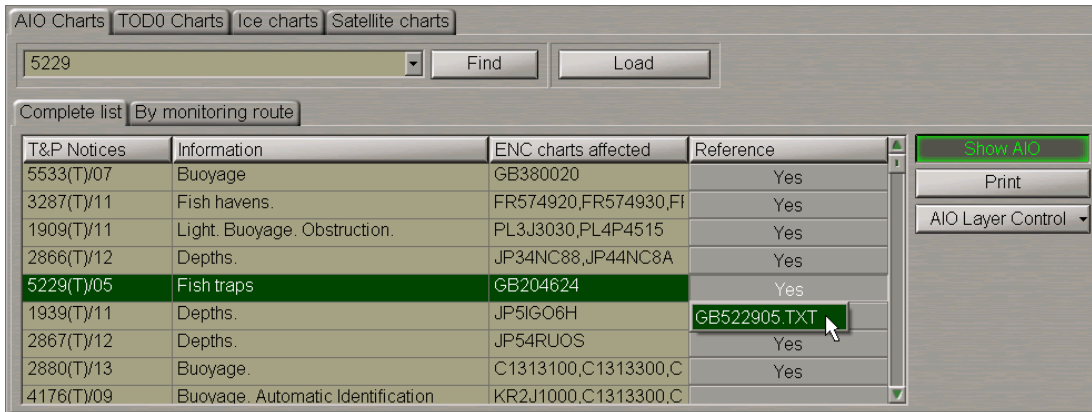

Select the *.txt file and press the left trackball button.

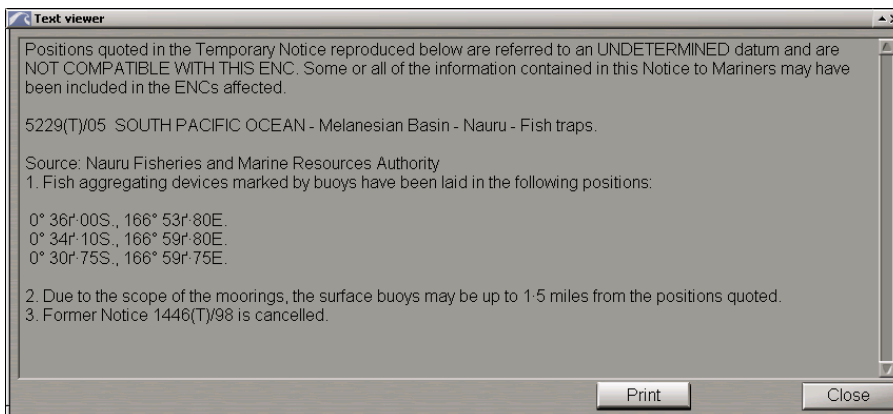

Read the NTM. If it is necessary to print out the NTM, press the Print button. To close the Text viewer window, press the Close button.

MFD implements a capability to show separately different object classes and polygon attributes. To do this press the AIO Layer Control button.

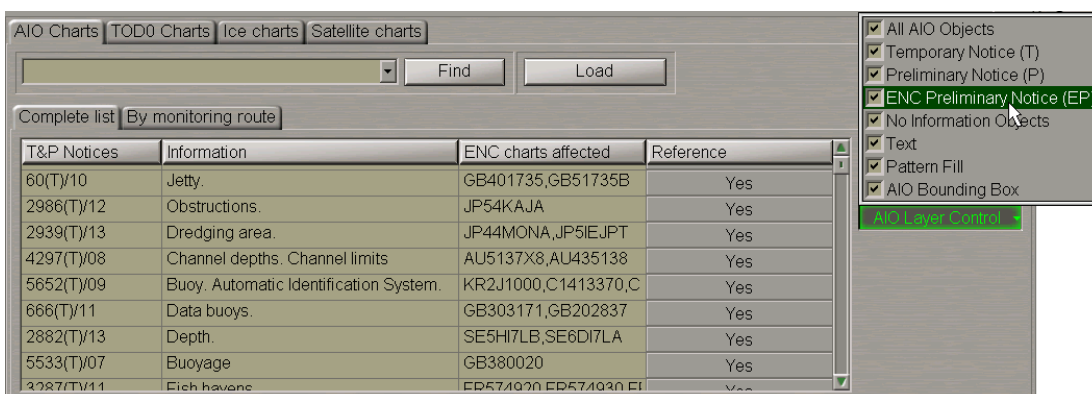

By default, the display of all the object classes and polygon attributes is turned on. The table below shows ways of displaying object classes on the Chart panel.

Object Class	Definition	Hatching colour on the Chart panel
Temporary Notice	Indicates an area on an ENC where UKHO has published a Temporary Notice to Mariners	Red
Preliminary Notice	Indicates an area on an ENC where UKHO has published a Preliminary Notice to Mariners, this includes (EP) NMs	Green
ENC Preliminary Notice	Indicates an additional preliminary information that is specific to ENCs, such as reported navigational hazards that are not yet charted	Blue
No Information	Indicates an area on an ENC where there is no equivalent BA chart coverage of the area	Grey

There is also a capability to display AIO geometric polygons with or without a fill and with text/boundaries turned on or off. The table below provides examples of polygon attributes display with the checkboxes checked/unchecked.

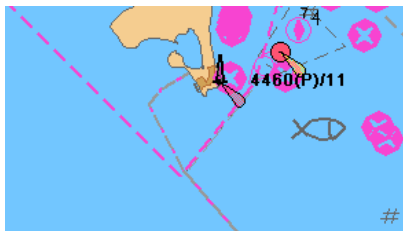
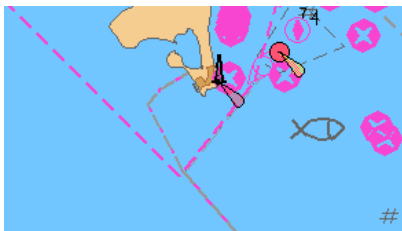
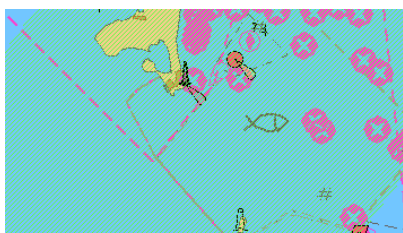
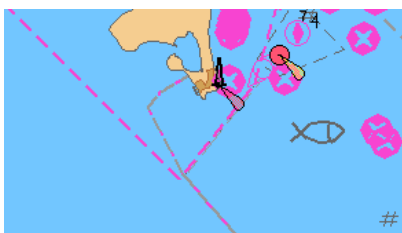
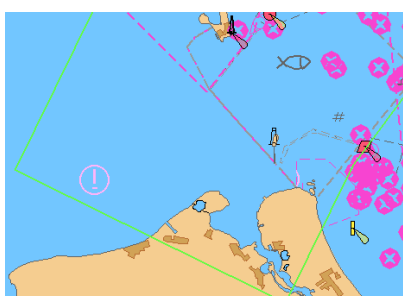
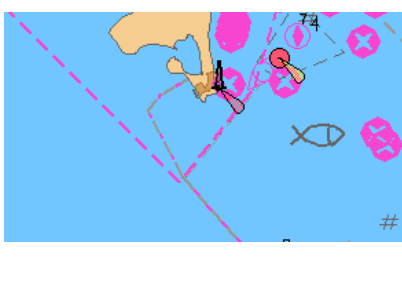
Polygon Attribute	Display On	Display Off
Text		
Pattern fill		
AIO Bounding Box		

If the display of all attributes is turned on, the polygon looks as follows:

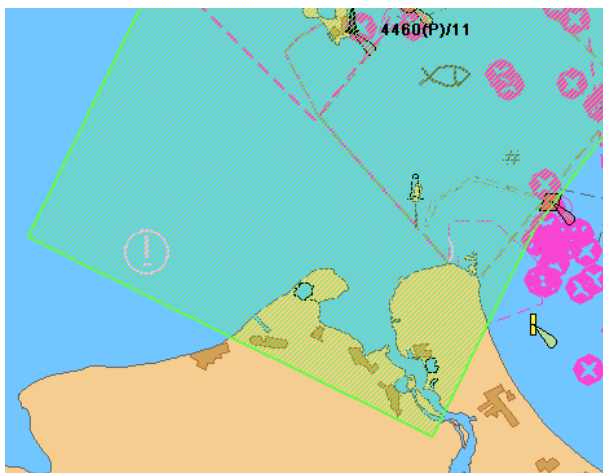

Handling TODO Charts

Note: TODO charts are installed by using the Navi-Planner 4000 application.

Open **Overlays** panel by selecting the appropriate line of **Tasks List** menu in the tabs zone of the ECDIS task screen.

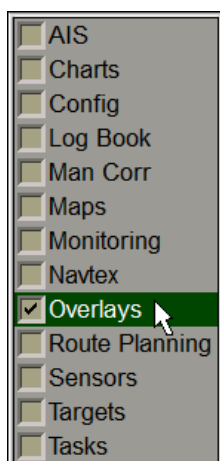

Use the tab in the top part of **Overlays** panel, which will open up, to switch to **TODO** page.

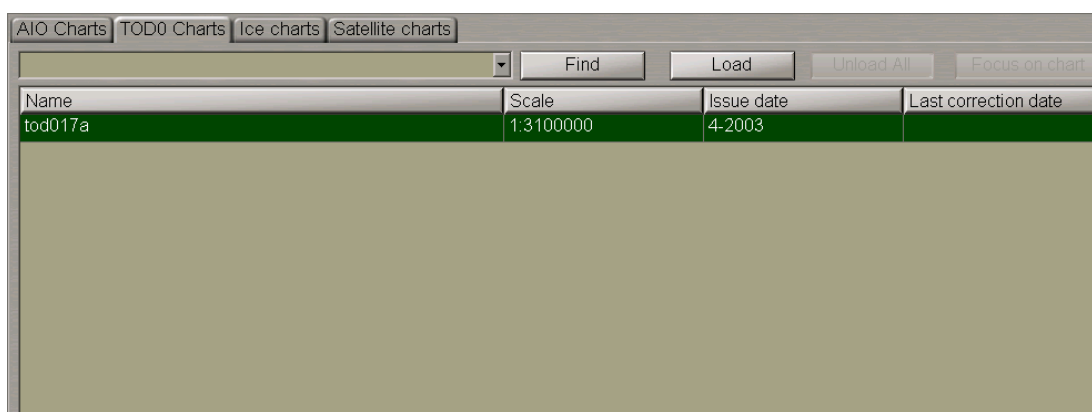

This page is intended for the handling TODO charts available in the ship collection. The panel contains the following buttons:

- **Find** – to activate the chart search function by the chart number entered in the window;
- **Load/Unload** – to load/unload selected chart;
- **Unload All** – to unload all charts;
- **Focus on chart** – display in the center of the ECDIS task screen.

The panel contains the table with installed TODO charts data:

- **Name** – TODO chart name;
- **Scale** – TODO chart scale;
- **Issue date** – TODO chart issue date;
- **Last correction date** – latest correction date.

Type the number or the first characters of a TODO chart in the input field, and press Find button.

The necessary chart will be highlighted in the table.

Select the necessary TODO chart from the table.

Press Load button, the selected chart will be loaded in the Chart panel.

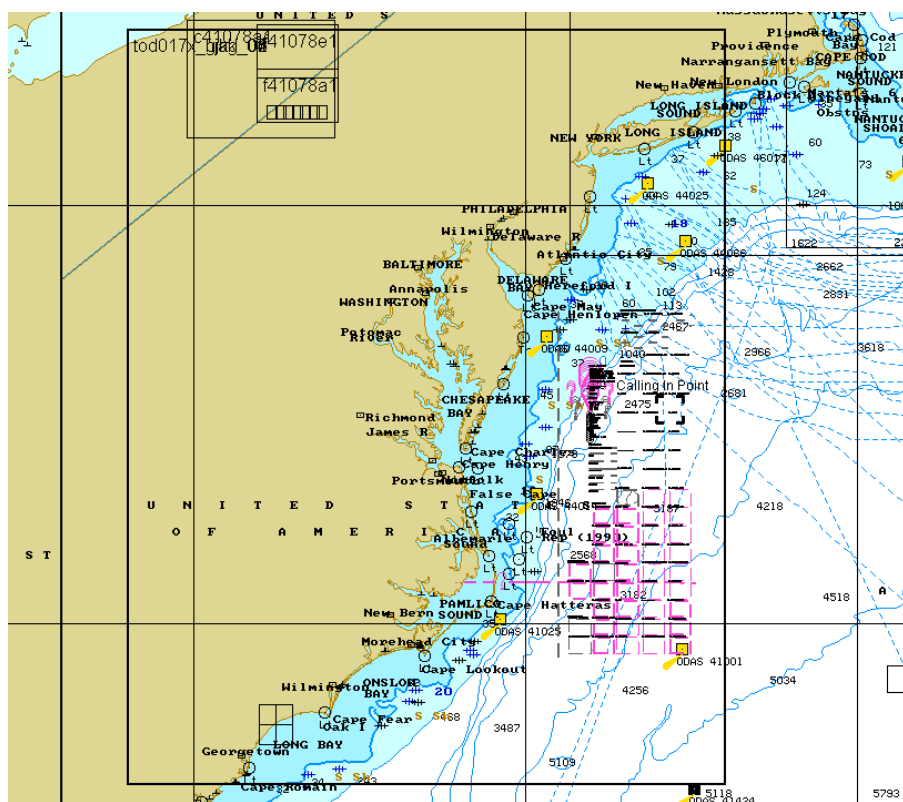

Press the Focus on chart button. The chart will display in the center of the ECDIS task screen.

Use the Info function (see *Chapter 11*, section *Obtaining Information on Vector Charts*). On the **Info** panel, select the TOD0 notation by positioning the cursor on it, and press the left trackball button. The page with information on the TOD0 chart will open up.

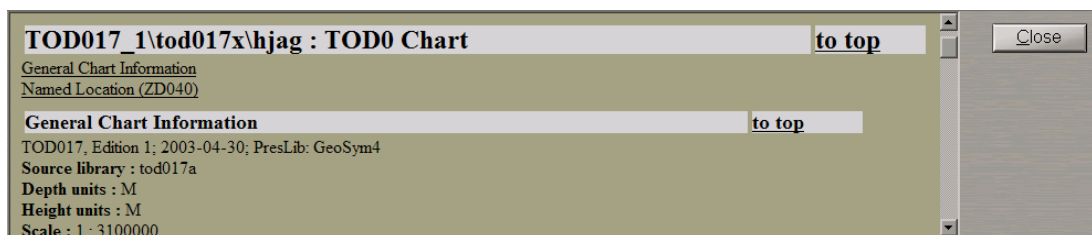

To unload selected TOD0 chart press **Unload** button. To unload all loaded TOD0 charts press **Unload All** button.

Using Auto Zoom Function

Auto Zoom mode enables the automatic increase of scale as the next waypoint is approached (see document *Multi-Functional Display (v. 3.00.340). Functional Description, Chapter 3*, section *Split Screen*). This mode is available on **Dual** panel only.

Open **Config** panel by selecting the appropriate line of the drop-down list **Tasks List** on the Control Panel.

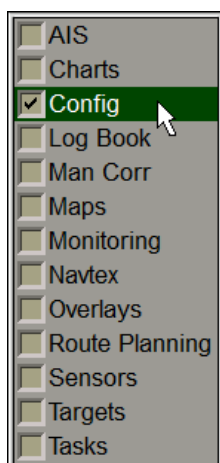

Use the tab in the top part of **Config** panel, which will open up, to switch to **General** page.

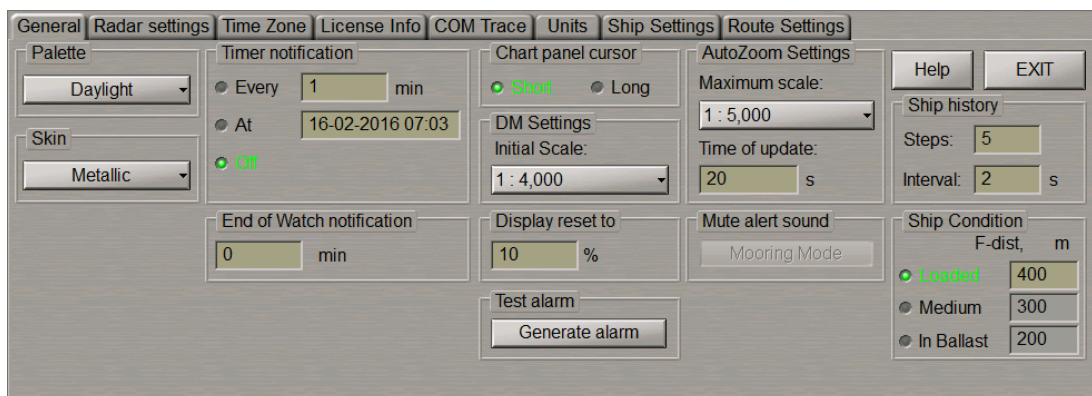

In **AutoZoom Settings** group from the drop-down list, select the maximum scale as the ship is passing the current WPT on **Dual** panel. In **Time of update** input window, set the DTW analysis interval.

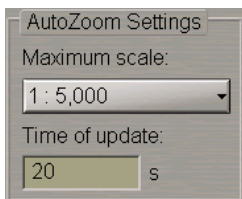

To turn on Auto Zoom mode, press **Az** button on **Dual** chart panel toolbar.

Note: The ship should be proceeding in the route monitoring mode.

In this case, as DTW is decreasing, the ECDIS task increases the scale by one fixed scale value so that the ship position remains within **Dual** panel. With the ship approaching the boundary of **Dual** panel in the process of manoeuvres, the scale may be reduced by one fixed scale value. With a change of the WPT, the scale is set so that **Dual** panel displays the ship symbol, current leg of the monitored route and the current WPT.

Using the Mooring Mode



Attention! Turning on/off Mooring Mode is available only at station with the status MASTER.

This mode is intended for mooring operations and sailing in the restricted waters with intensive maneuvering. Open **Config** panel by selecting the appropriate line of the drop-down list **Tasks List** on the Control Panel.

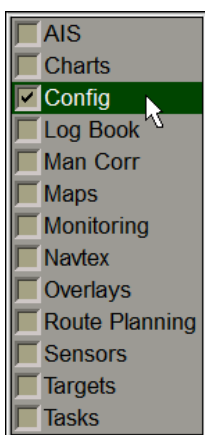

Use the tab in the top part of **Config** panel, which will open up, to switch to **General** page.

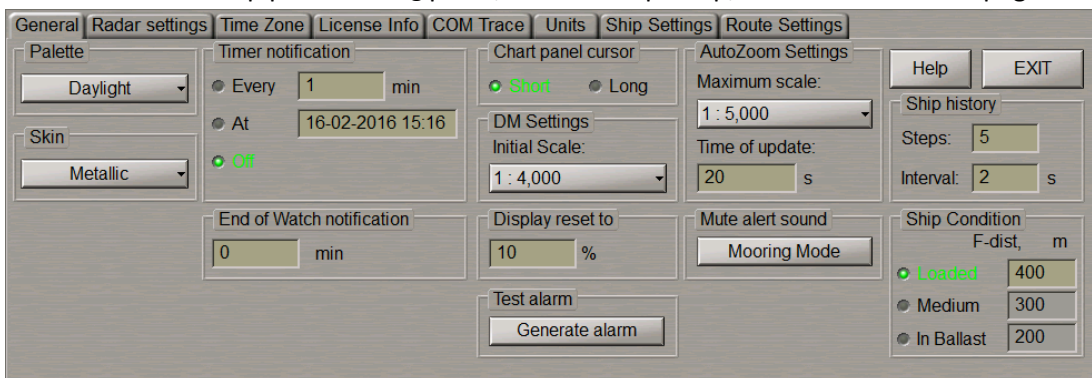

In Mute alert sound group press **Mooring Mode** button.

Note: The mooring mode cannot be enabled as long as the ownship speed exceeds 5 knots (the **Mooring Mode** button is greyed).

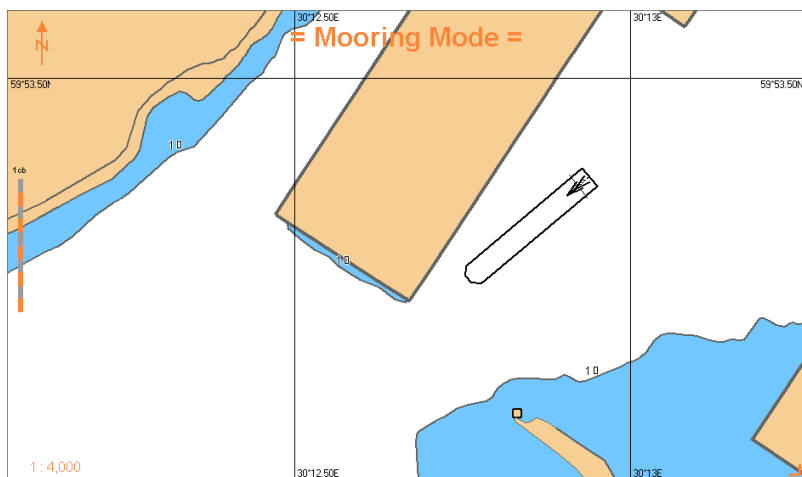

In this case, the **Mooring Mode** warning appears in the top part of the Chart Panel, and the sound associated with some alerts is turned off.

As the Mooring mode is turned on, a full event named “Mooring Mode ON” is entered in the log.

To turn off the Mooring Mode, press the **Mooring Mode** button again. In this case, a full event names “Mooring Mode OFF” is entered in the log.

Alerts disabled in Mooring mode:

Alert name	Alert name
DLOG: STW no data	POSN. integrity failed
DLOG: no input	SOG integrity failed
LOG no input	STW Integrity failed
LOG no data	

Search and Rescue Operations

Using Man Overboard (MOB) Mode

MOB mode enables the display of information on a geographic point saved at a certain time. There are three ways to turn on MOB mode:

1. Press  button on the Chart panel toolbar.
2. Press <MOB> key on the ES6 keyboard.
3. Press external MOB button (see document *Multi-Functional Display (v. 3.00.340). Installation Guide Part I, Annex B, section Adjustment of MFD Operation with WAGO Modules, paragraph Connection of External MOB Button*).

As this is done, the system makes a logbook entry which contains the name of the event: “MOB ENABLED” and a full set of recorded parameters. Control panel displays a panel shown below:

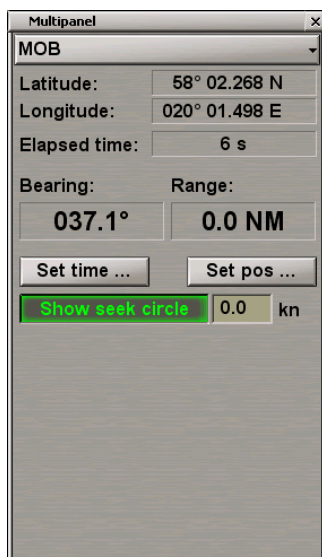

The following parameters can be displayed:

- coordinates of MOB mode activation;
- time elapsed since MOB mode was activated;
- bearing from the ship current position to the activation point;
- distance from the ship current position to the activation point.

If you know the MOB event time, press on **Set time...** button.

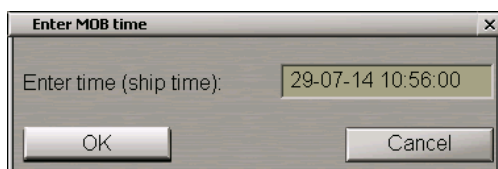

In the input window, enter the MOB event time: MOB point is set in the own ship track point closest to the entered time.

If you know the MOB event coordinates, press **Set pos...** button.

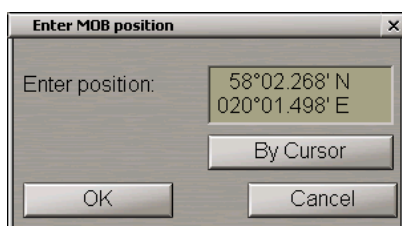

In the input box, enter the MOB coordinates: the MOB display is re-drawn to suit the entered data (e.g., upon receipt of coordinates from another ship).

You can also use the cursor for setting the MOB coordinates. To do this, press the **By Cursor** button.

Move the graphic cursor, which will appear, to the MOB coordinates.

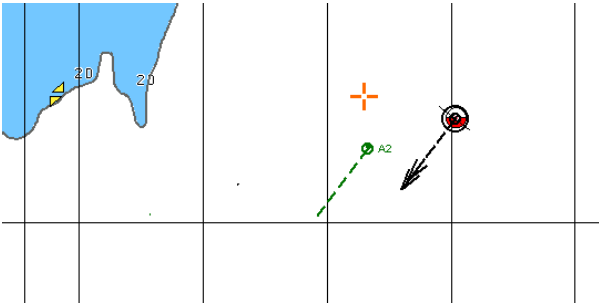

Press the left trackball button, the cursor will assume the form of a free cursor.

Press the OK button in the **Enter MOB position** window.

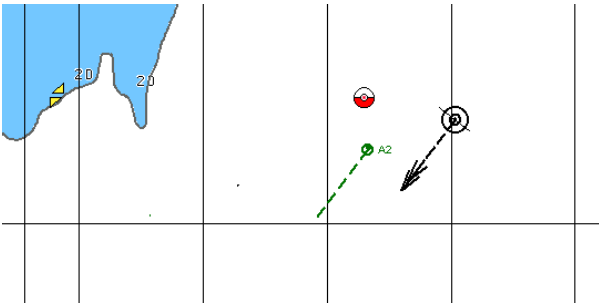

The MOB symbol will move to the specified coordinates.

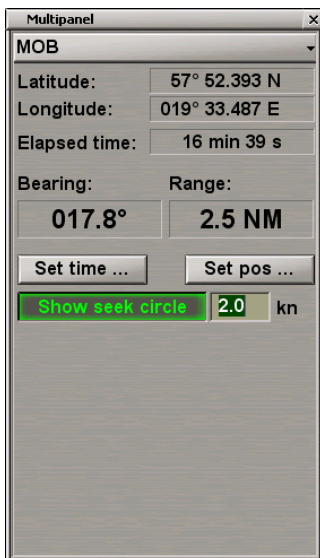

The Show seek circle button is enabled by default. Use the input box to the right of the button to enter the seek circle expansion rate different from 0.

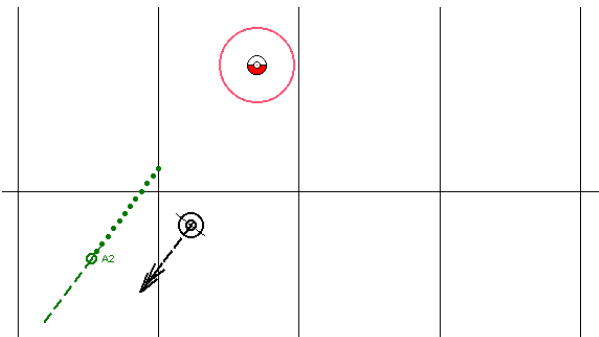

The Chart panel will display a red-coloured MOB- point-centred seek circle which will be expanding at the set rate. Turn off the seek circle display as required by releasing the button.

To turn the MOB mode off, second press  button on the Chart panel toolbar or <MOB> key on the ES6 keyboard.



Press **Yes** button. Electronic log entry containing “MOB DISABLED” event name, is made.

For the operation of MOB over the AIS, see document *Multi-Functional Display (v. 3.00.340). Additional Functions, Chapter 1, section MOB Mode with Use of RDF Rhotheta RT-202/RT-500M*.

Creating SAR Routes

Open **Tasks** panel by selecting the appropriate line of **Tasks List** menu in the tabs zone of the ECDIS task screen.

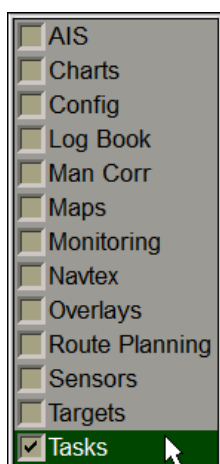

Use the tab in the top part of **Tasks** panel to switch to **SAR** page.

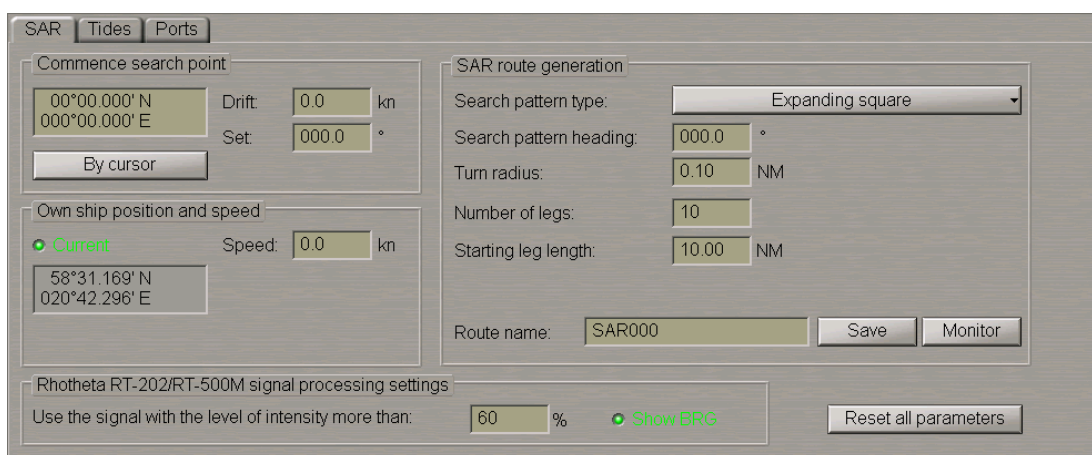

There are two ways to set the SAR route start point coordinates in the **Commence search point** group:

1. Enter the SAR route start point coordinates in the input window.
2. Press **By cursor** button. Move the graphic cursor, which will appear, to the SAR route start point coordinates.

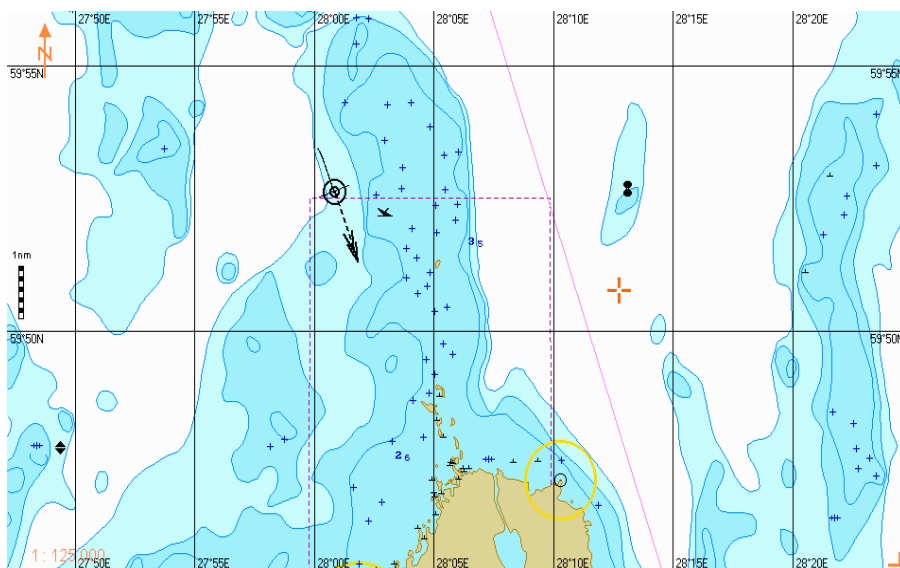

Press the left trackball button.

In **Drift** and **Set** input windows, set the expected drift and set at the SAR operation site.

In **Own Ship Coordinates** group, set the coordinates of the point of turn to the SAR route start point. If the current ship coordinates are obtained from the positioning system and are then updating until the route save moment, check **Current** checkbox.

In **Speed** set the expected speed of proceeding along the SAR route.

Expanding Square Route

Press the button **Search pattern type** in **SAR route generation** group. In the list, which will open up, select **Expanding square** line and press the left trackball button (see document *Multi-Functional Display (v. 3.00.340)*, *Functional Description*, *Chapter 5*, section *SAR Routes*).

SAR route generation	
Search pattern type:	Expanding square
Search pattern heading:	000.0 °
Turn radius:	0.10 NM
Number of legs:	10
Starting leg length:	10.00 NM
Route name:	SAR006
<input type="button" value="Save"/> <input type="button" value="Monitor"/>	

Set the following SAR route parameters:

- **Search pattern heading** – search direction;
- **Turn radius** – turn radius between the route legs;
- **Number of legs** – number of successive route legs;
- **Starting leg length** – start leg length.

Enter the SAR route name in the **Route name** line and press the **Save** button to save the route.

To quick load this SAR route to monitoring mode, press **Monitor** button.

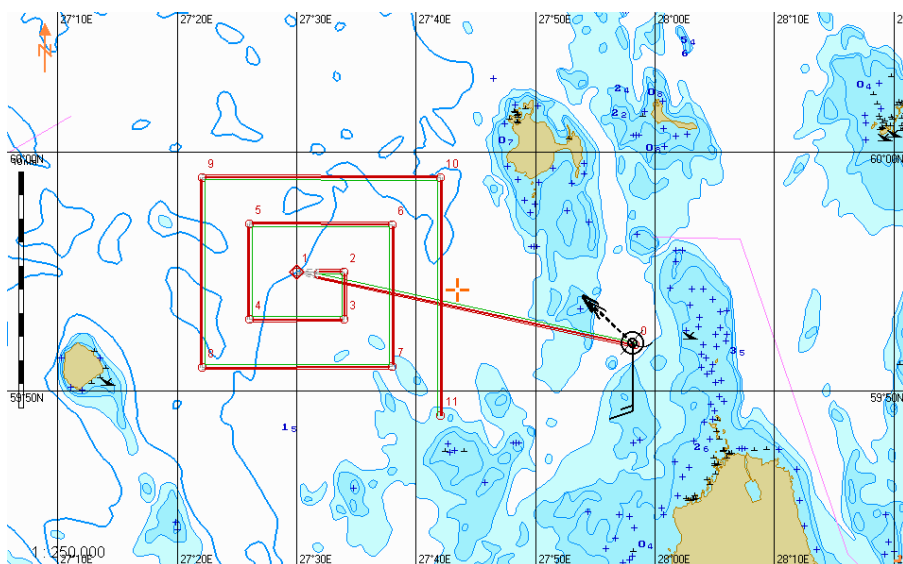

Parallel Tracks Route

Press the button **Search pattern type** in **SAR route generation** group. In the list, which will open up, select **Parallel tracks** line and press the left trackball button (see document *Multi-Functional Display (v. 3.00.340), Functional Description, Chapter 5, section SAR Routes*).

SAR route generation	
Search pattern type:	Parallel tracks
Search pattern heading:	000.0 °
Turn radius:	0.10 NM
Number of legs:	10
Leg length:	10.00 NM
Track spacing:	1.0 NM
Route name:	SAR006
	Save Monitor

Set the following SAR route parameters:

- **Search pattern heading** – search direction;
- **Turn radius** – turn radius between the route legs;
- **Number of legs** – number of successive route legs;
- **Leg length** – length of each leg;
- **Track spacing** – width of zone between the parallel tracks.

Enter the SAR route name in the **Route name** line and press **Save** button to save the route.

To quick load this SAR route to monitoring mode, press **Monitor** button.

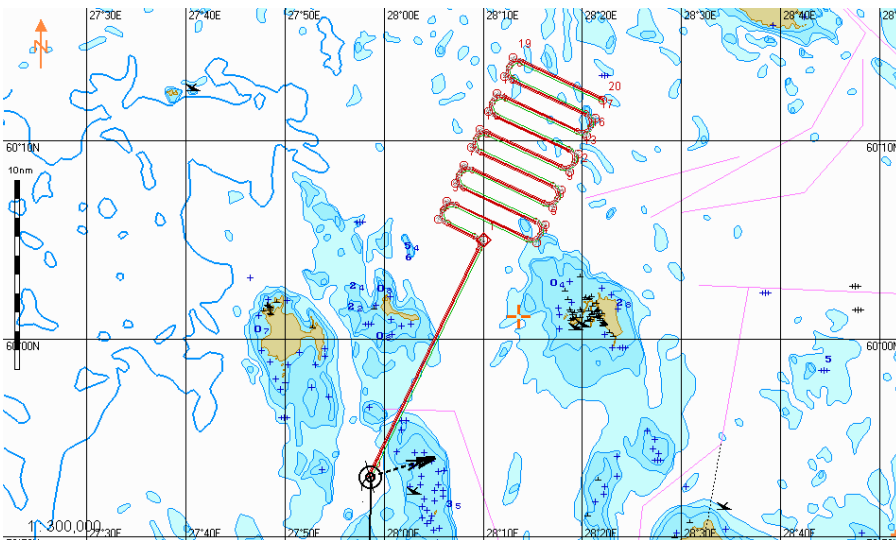

Sector Search Route

Press the button **Search pattern type** in **SAR route generation** group. In the list, which will open up, select **Sector search line** and press the left trackball button (see document *Multi-Functional Display (v. 3.00.340). Functional Description, Chapter 5, section SAR Routes*).

SAR route generation	
Search pattern type:	Sector search
Search pattern heading:	000.0 °
Turn radius:	0.10 NM
Number of sectors:	6
Search radius:	10.0 NM
Turn angle:	030.0 °
Route name:	SAR006
	Save Monitor

Set the following SAR route parameters:

- **Search pattern heading** – search direction;
- **Turn radius** – turn radius between the route legs;
- **Number of sectors** – number of sectors;
- **Search radius** – search area radius (sectors);
- **Turn angle** – sector turn angle.

Enter the SAR route name in the **Route name** line and press **Save** button to save the route.

To quick load this SAR route to monitoring mode, press **Monitor** button.

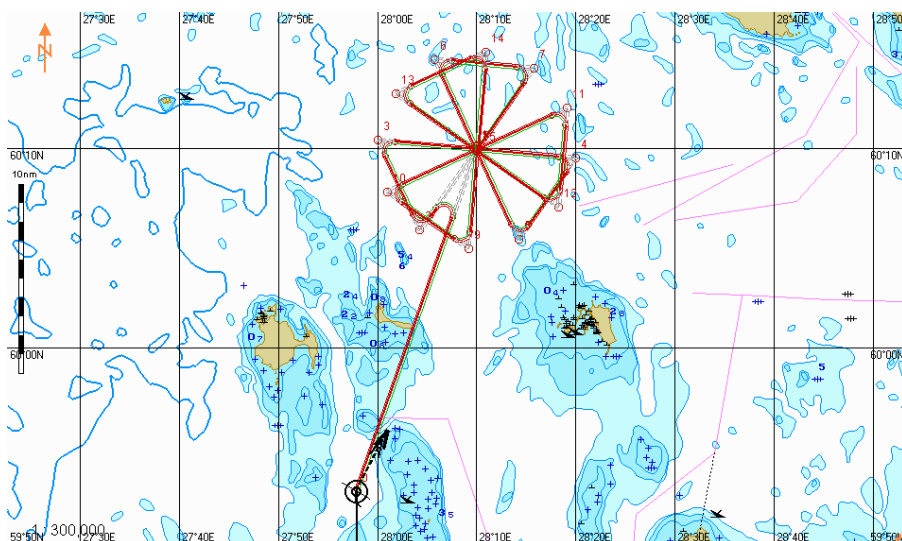

Track Line Search Route

Press the button **Search pattern type** in **SAR route generation** group. In the list, which will open up, select **Track line search** and press the left trackball button (see document *Multi-Functional Display (v. 3.00.340). Functional Description, Chapter 5, section SAR Routes*).

SAR route generation	
Search pattern type:	Track line search
Search pattern heading:	000.0 °
Turn radius:	0.10 NM
Leg length:	10.00 NM
Track spacing:	1.0 NM
<input checked="" type="radio"/> Return to initial position	
Route name:	SAR006 <input type="button" value="Save"/> <input type="button" value="Monitor"/>

Set the following SAR route parameters:

- **Search pattern heading** – search direction;
- **Turn radius** – turn radius between the route legs;
- **Leg length** – length of each leg;
- **Track spacing** – width of zone between the parallel tracks;
- **Return to initial position** – to plot the SAR route with a return to the initial position.

Enter the SAR route name in the **Route name** line and press **Save** button to save the route.

To quick load this SAR route to monitoring mode, press **Monitor** button.

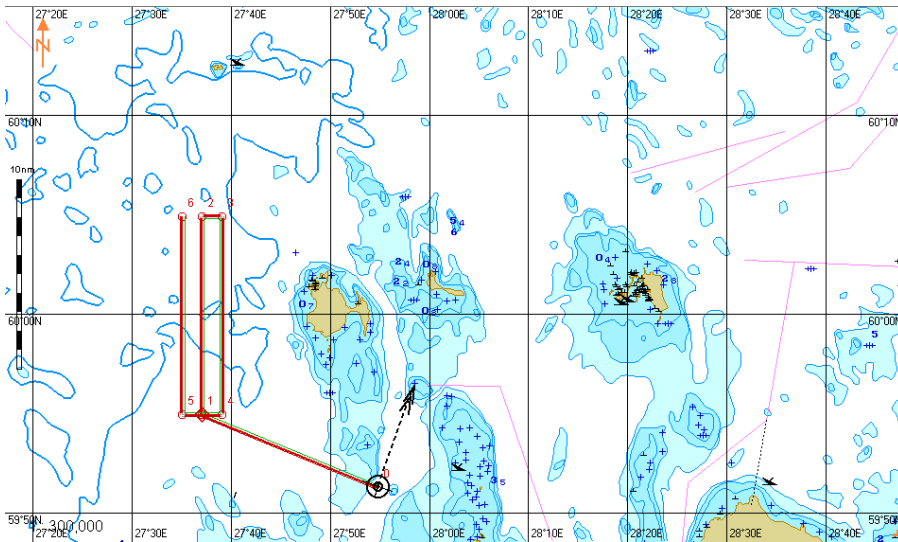

Creeping Line Search Route

Press the button **Search pattern type** in **SAR route generation** group. In the list, which will open up, select **Creeping line search** and press the left trackball button (see document *Multi-Functional Display (v. 3.00.340). Functional Description, Chapter 5, section SAR Routes*).

SAR route generation			
Search pattern type:	Creeping line search		
Search pattern heading:	000.0	°	
Turn radius:	0.10	NM	
Number of legs:	10	● Aircraft speed:	0.0 kn
Leg length:	10.00	● Ship speed:	0.0 kn
Track spacing:	1.0	NM	
Route name:	SAR006	Save	Monitor

Set the following SAR route parameters:

- **Search pattern heading** – search direction;
- **Turn radius** – turn radius between the route legs;
- **Leg length** – length of each leg;
- **Track spacing** – width of zone between the parallel tracks.

Select a rescue facility whose speed is known and enter it in the input box to the right:

1. If the **Aircraft speed** is selected, the recommended ship speed, calculated from a certain formula, will be displayed automatically in the **Ship speed** box:

SAR route generation

Search pattern type: Creeping line search

Search pattern heading: 000.0 °

Turn radius: 0.10 NM

Number of legs: 10 Aircraft speed: 165.0 kn

Leg length: 10.00 NM Ship speed: 15.0 kn

Track spacing: 1.0 NM

Route name: SAR006

Enter the SAR route name in the **Route name** line and press **Save** button to save the route.

For quick loading of this SAR route to the monitoring mode, press the **Monitor** button. In this case, the recommended route for a ship engaged in search will look like follows:

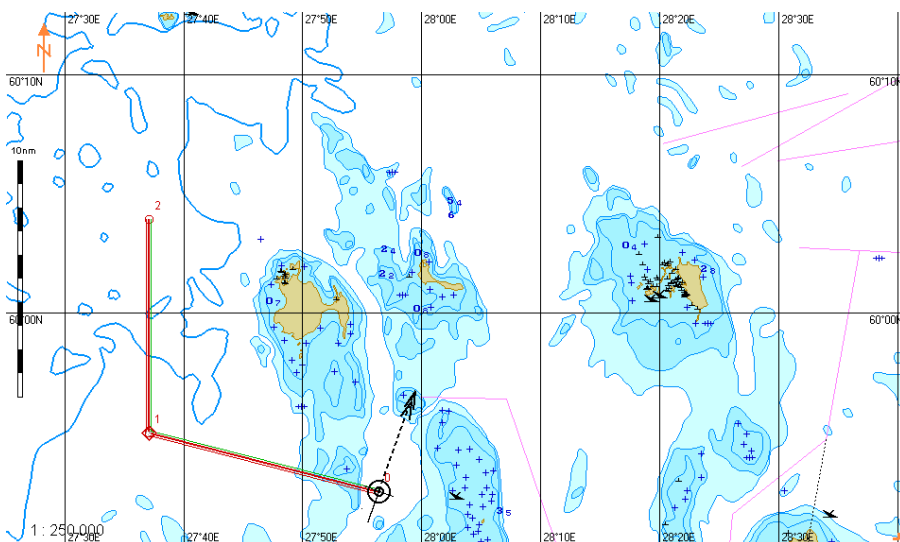

2. If the **Ship speed** is selected, the recommended aircraft speed, calculated from a certain formula, will be displayed automatically in the **Aircraft speed** box:

SAR route generation

Search pattern type: Creeping line search

Search pattern heading: 000.0 °

Turn radius: 0.10 NM

Number of legs: 10 Aircraft speed: 165.0 kn

Leg length: 10.00 NM Ship speed: 15.0 kn

Track spacing: 1.0 NM

Route name: SAR006

Enter the SAR route name in the **Route name** line and press the **Save** button to save the route.

For quick loading of this SAR route to the monitoring mode, press the **Monitor** button. In this case, the recommended route for the aircraft engaged in search will look like follows:

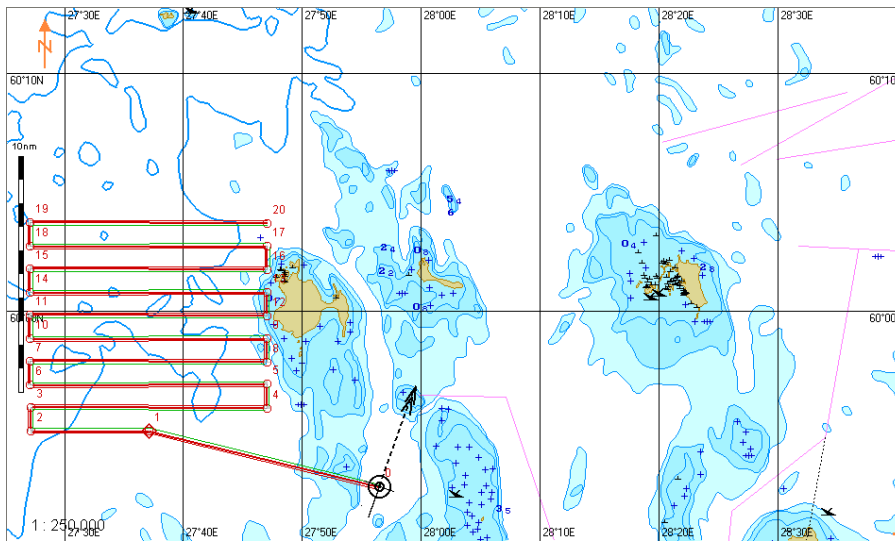

Using Special Purpose Objects



Attention! Work with Special Purpose Objects is only available at a station with the MASTER status.

Press the button with the name of the set display in the **Display Panel** window of the Control panel.

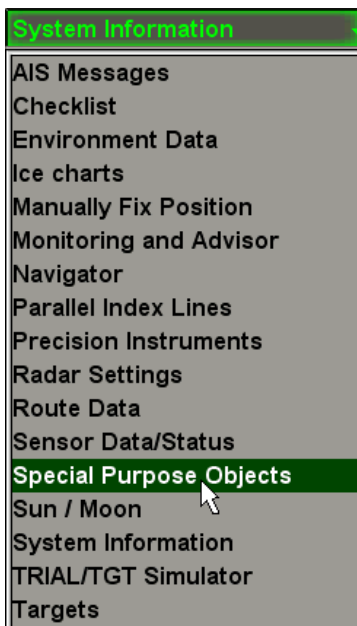

In the list, which will open up, select **Special Purpose Objects** line and press the left trackball button.

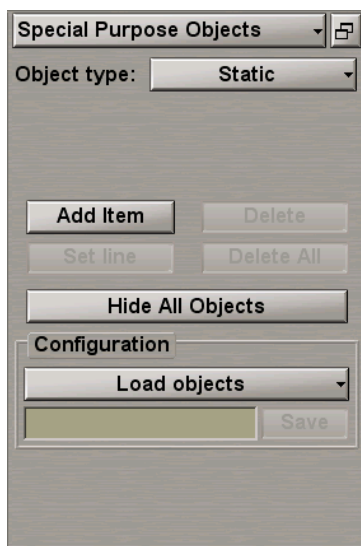

This MFD functionality enables special purpose objects (SPO), mobile and fixed, with certain features to be created and referenced to an electronic chart with the purpose of their further monitoring and obtaining of auxiliary information.

SPO Creating

Select the type of SPO to be created. Press the **Object type** button and select the appropriate item from the drop-down list:

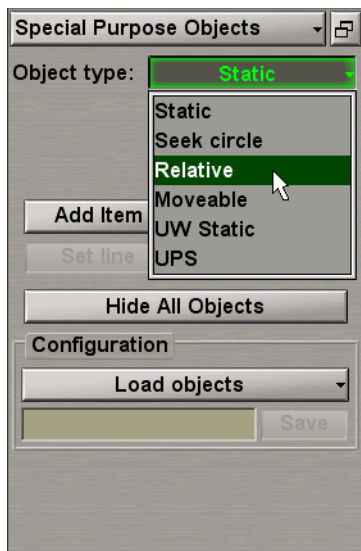

The following types of SPO are available for selection:

- **Static** – the fixed surface object: Target with constant coordinates;
- **Seek circle** – the search circle: Target with constant coordinates around which a circle is formed at the specified moment of time, increasing in accordance with settings made by the user;
- **Relative** – the “satellite”: Target with motion parameters identical to the own ship’s course and speed;
- **Moveable** – the mobile object: Target with arbitrary motion parameters;
- **UW Static** – the fixed submerged object: Target with constant coordinates and depth;
- **UPS** – the UPS: Target with constant coordinates, reference point.

Press **Add Item** button. Position the acquisition marker (graphics cursor) on the point where the SPO is required to be plotted.

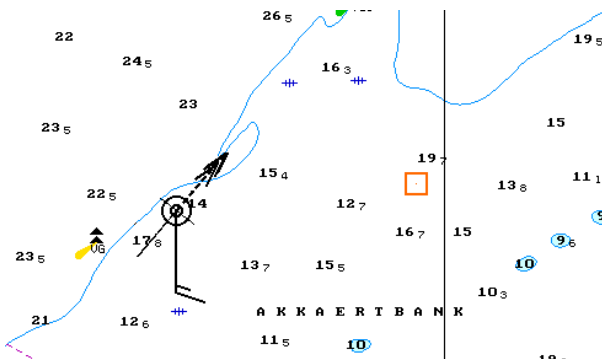

Press the left trackball button: SPO will be set in the specified coordinates.

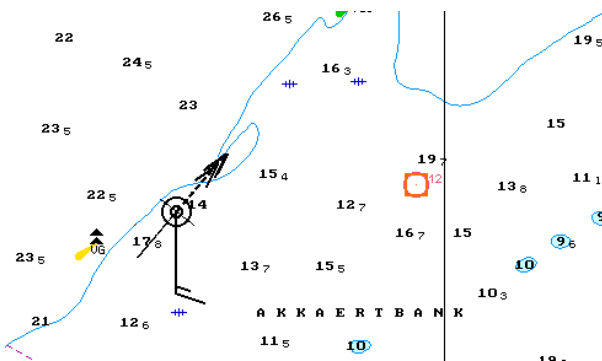

Repeat the procedure until you set the required number of SPO. After the input of the last SPO, press the right trackball button to exit from the SPO setting mode.

SPO Deleting

Press Delete button. Position the marker on the SPO is required to be deleted.

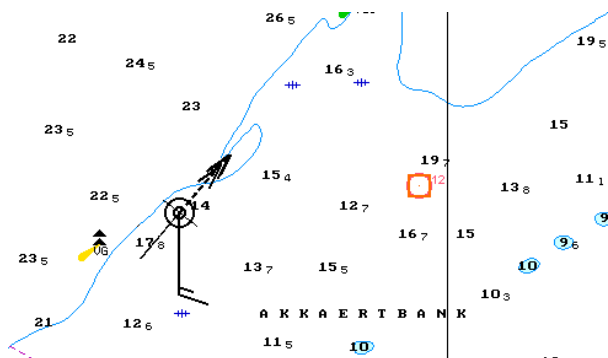

Press the left trackball button.

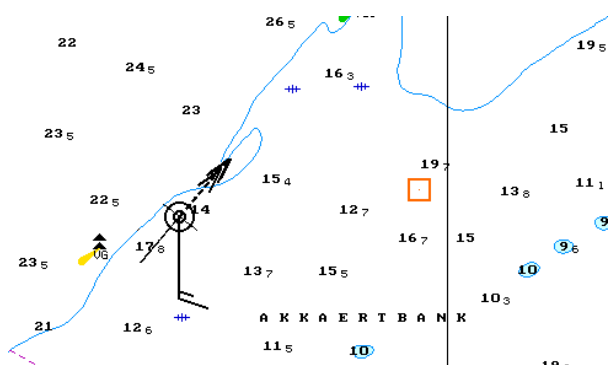

If it is necessary to delete all the previously plotted objects simultaneously, including when the SPO is not displayed on the screen, use Delete all button.

Other Functions

To plot the line connecting the own ship symbol and selected SPO, press Set line button. Position the marker on the required SPO.

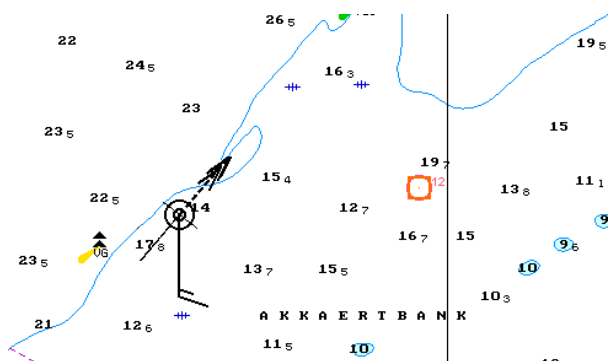

Press the left trackball button.

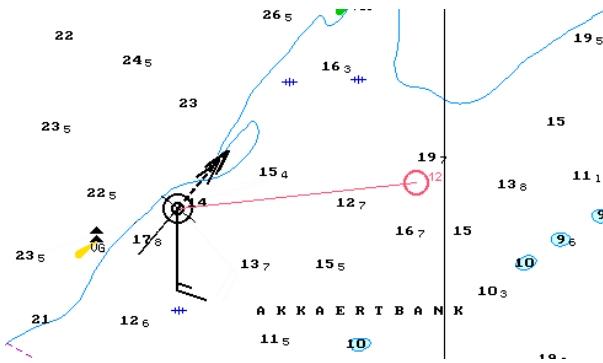

To hide all the SPO, press **Hide All Objects** button. Repeated pressing this button results in re-appearing of all the hidden SPO.

Saving and Loading SPO Configuration

Note: SPO of the following types only can be saved: Static, UW Static and UPS.



To save the SPO configuration, enter the configuration name in the input line of **Configuration** group and press the **Save** button, which will be enabled. SPO configuration files are accessible with the use of the Data Tool utility, in the **SPO objects** group of **SPO objects** feature, and can be imported/exported from/to another PC.

To load SPO configuration, press **Load objects** button in **Configuration** group.



From the drop-down list, select the necessary configuration.

Chapter 5.

Setting of Safety Parameters

This chapter describes the procedure used in the setting of safety parameters.

<u>Monitoring of Sailing along the Route and by the Schedule</u>	156
<u>Monitoring of Safety Alerts</u>	158
Setting of Safety Parameters for the Detection of Dangerous Objects	158
Setting of Safety Parameters in the Sailing in the Vicinity of Dangerous Objects	161
Monitoring of Crossing of Area Limits in IMO and Additional Groups	162
<u>Safety Tools</u>	163
Clearing Bearing	163
Saving and Loading Configuration	170
<u>Monitoring of Navigational Alerts</u>	172
<u>Monitoring of Time</u>	174
Setting of End-of-Watch Alerts	175
Setting of the Timer	175

Monitoring of Sailing along the Route and by the Schedule

Attention! Setting of safety parameters in the sailing along the route and by the schedule is available only at station with the status MASTER.

Open **Monitoring** panel by selecting the appropriate line of **Tasks List** menu in the tabs zone of the ECDIS task screen.

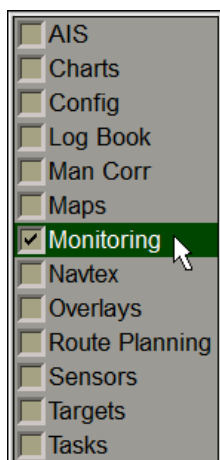

Use the tab in the top part of **Monitoring** panel, which will open up, to switch to **Route Monitoring** page.

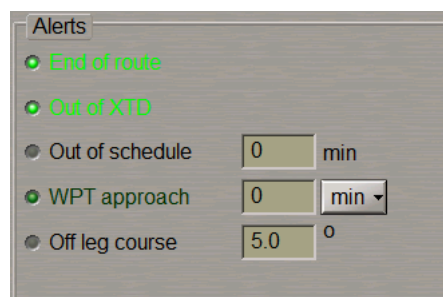
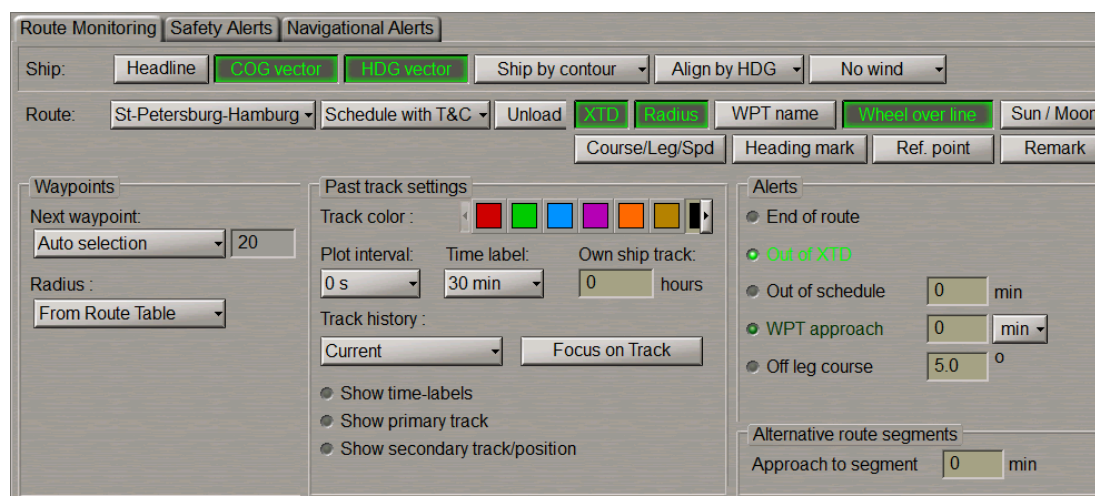

Alerts group is intended for turning on/off and setting of safety parameters for the alert generation during the sailing along the route and according to the schedule:

- **End of route** – to enable alert generation as the last WPT of the monitored route is passed;
- **Out of XTD** – to enable alarm generation when the ship deviation from the route line is larger than the value set during the route planning;
- **Out of schedule** – to enable and set of alerts generated when the ship is behind or ahead of the schedule;
- **WPT approach** – to enable alert generation as a set period of time before the approach to the WPT;
- **Off leg course** – to enable and set parameters of the alert generated if the deviation between the current course (HDG) and the route leg line direction exceeds the set value.

Check **End of route** checkbox in **Alerts group** to turn on the alert generation as the last point of the route is passed.

End of route

The parameter of tracking the ship position relative to the current route leg is set by default. XTD value is set at the time when the route is created in **Route Planning** panel. The alarm is generated when the ship sails beyond the XTD limits.

Out of XTD

Use **WPT approach** to line to enter the alert generation time value as the next WPT is approached. Check the activated **WPT Approach** checkbox to turn on the alert generated if the value of time of approach to the next WPT is less than the set one.

WPT approach 5 min

Use **Off leg course** line to enter the value of difference between the ship course and route leg direction. Check the activated **Off leg course** checkbox to turn on the alert generation as the difference between the courses exceeds the set value.

Off leg course 5.0 °

Use **Out of schedule** line to enter the behind-the-schedule or ahead-of-the-schedule time relative to the loaded schedule. The alert is generated when the set value is exceeded. Check the activated **Out of schedule** checkbox.

Out of schedule 10 min

Monitoring of Safety Alerts

Attention! Setting of safety parameters for the detection objects representing danger to navigation is available only at station with the status MASTER.

Open **Monitoring** panel by selecting the appropriate line of **Tasks List** menu in the tabs zone of the ECDIS task screen.

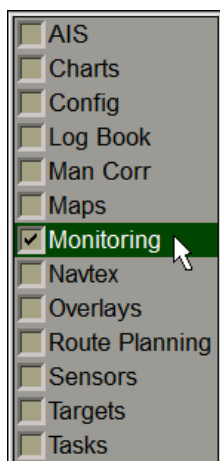

Use the tab in the top part of **Monitoring** panel, which will open up, to switch to **Safety Alerts** page.

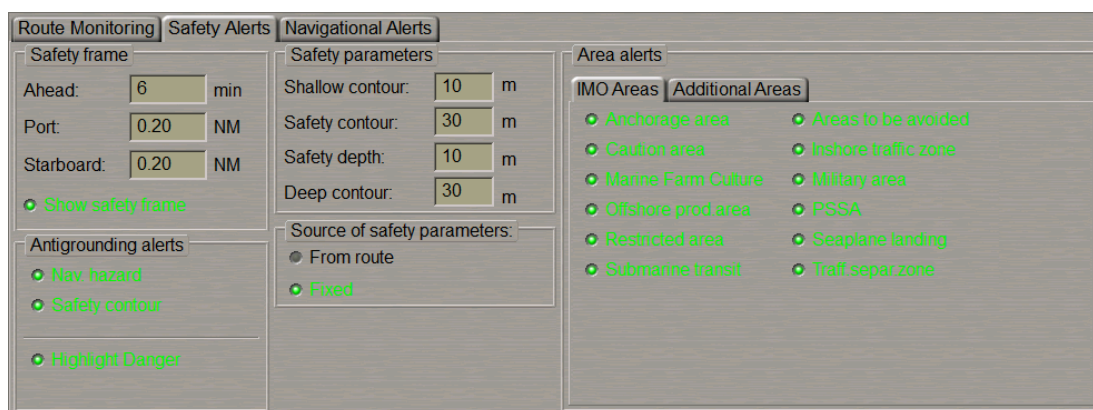

Setting of Safety Parameters for the Detection of Dangerous Objects

The **Safety frame** group is intended for setting the size of the frame, which will be used for the chart data analysis and for the generation of the Antigrinding alerts, Area alerts and Navigational alerts.



- **Ahead** – window for the input of advance time for alert generation. The time value determines the length equal to the distance covered by the ship proceeding at the current SOG (from 1 to 20 min);
- **Port** – to set the width of the corridor to the left of the ship (from 0.1 to 4.0 NM);
- **Starboard** – to set the width of the corridor to the right of the ship (from 0.1 to 4.0 NM);
- **Show safety frame** – to turn on the display of a safety frame on the ECDIS task screen.

In the **Ahead**, **Port** and **Starboard** input boxes, set the necessary values which will determined the shape of the safety frame.

Check the **Show safety frame** checkbox to show the safety frame. The safety frame is displayed with a black outlined rectangle:

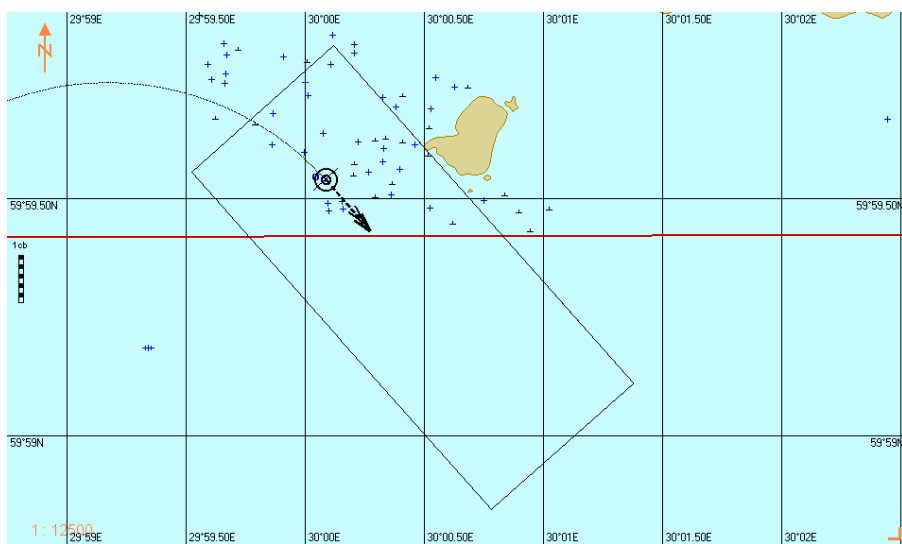

Safety parameters group is intended for the setting and viewing of safety parameters in the Navigation Mode:

Safety parameters		
Shallow contour:	10	m
Safety contour:	10	m
Safety depth:	10	m
Deep contour:	10	m

- **Shallow contour** - in the ENC four shades mode defines the value of the shallow contour affecting colours of depth areas (dark blue for depth areas with values shallower than the shallow contour);
- **Safety contour** - mariner-selected contour to distinguish on the display between safe and unsafe water;
- **Safety depth** - mariner-defined depth to emphasize soundings on the display equal to or less than this value;
- **Deep contour** - in the ENC four shades mode defines the value of deep contour affecting colours of depth areas (the lightest S-52 colour for depth areas deeper than the deep contour).

Shallow contour:	10	m
------------------	----	---

Use **Shallow contour** line to enter the value of the shallow contour affecting colours of depth areas for ENC format charts.

Safety contour: m

Use **Safety contour** line to enter the safety contour value.

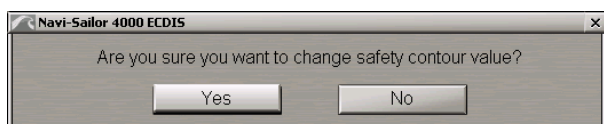

Press **Yes** button to confirm the changes you have made.

Safety depth: m

Note: The alert is generated exclusively by the safety contour value, even if the shallow contour value is smaller than the safety contour value.

Use **Safety depth** line to enter the safety depth value.

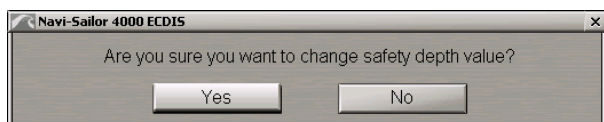

Press **Yes** button to confirm the changes you have made.

Deep contour: m

Use **Deep contour** line to enter the value of deep contour affecting colours of depth areas for ENC format charts.

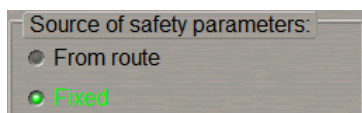

In the **Source of safety parameters** group, select the source which the safety parameters will be taken from for the route monitoring.

If the route is not loaded for monitoring, the **Fixed** radio button will be selected automatically, safety parameters set in the **Safety parameters** group are used for monitoring dangers.

As a route to be monitored is loaded, the last operator-selected **From route** or **Fixed** value is set automatically.

If the **Fixed** value is selected, the safety parameters set in the **Safety parameters** group are used (see also document *Multi-Functional Display (v. 3.00.340). Functional Description, Chapter 4, section Main Alerts Generation Principles, paragraph Safety Alerts*).

If the **From route** value is selected, safety parameters are selected by using the procedure detailed in *Chapter 4, section Loading of Route and Schedule in the Navigation Mode, paragraph Selection of Safety Parameters when Loading Monitored Route*).

Setting of Safety Parameters in the Sailing in the Vicinity of Dangerous Objects

Antigrounding alerts group contains checkboxes for enabling/disabling the following safety parameters:

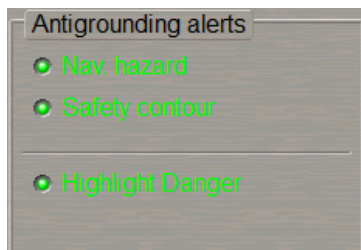

- **Nav. hazard** – to enable the caution generation upon the approach to the navigational hazards (the list of objects see document *Multi-Functional Display (v. 3.00.340). Functional Description, Chapter 4, section Main Alerts Generation Principles, paragraph Safety Alerts*);
- **Safety contour** – to enable the alarm generation upon the approach to the depth line less than the **Safety contour** value;
- **Highlight Danger** - to turn on the highlight the dangers on the Chart panel.

Check the activated **Nav. hazard** checkbox to enable the caution generation when the navigational hazards turns up within the safety frame.

Check the **Safety contour** checkbox to turn on the alarm generation as the safety contour is crossed by the safety frame.

Check the **Highlight Danger** checkbox to turn on the highlighting of the dangers on the Chart panel falling within the safety frame.

Note: If at least one checkbox in the **Antigrounding alerts** group is unchecked, the Chart panel displays the **SF CNT** important indication (for details see document *Multi-Functional Display (v. 3.00.340). Functional Description, Chapter 4, section Indications, paragraph Important Indications*).

Monitoring of Crossing of Area Limits in IMO and Additional Groups

IMO Areas tab containing checkboxes for the selection (assigning danger-to-navigation status) from the main areas tracked in accordance with IEC-61174 standard.

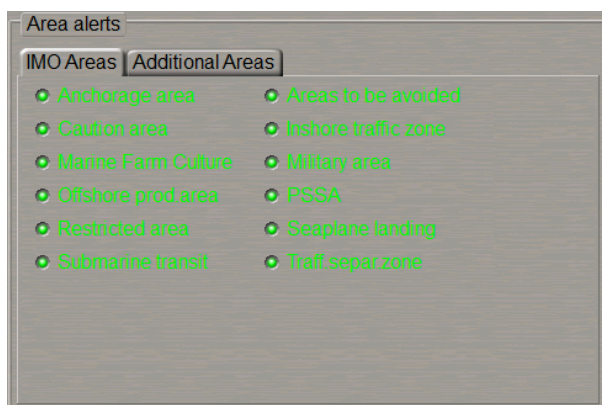

Additional Areas tab containing checkboxes for the selection (assigning danger-to-navigation status) from the additional group of those areas, which will be tracked.

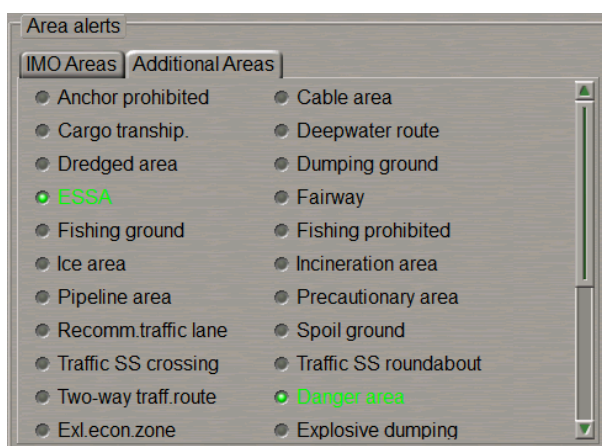

Select the required areas by checking the appropriate checkboxes in **IMO Areas** tab.

Switch to **Additional Areas** tab. Select the required areas by checking the appropriate checkboxes in **Additional Areas** tab.

For details see document *Multi-Functional Display (v. 3.00.340). Functional Description, Chapter 4, section Main Alerts Generation Principles*, paragraph *Safety Alerts*.

Safety Tools

Clearing Bearing

Clearing Bearing allows the construction of visual bearings around dangers at an appropriate distance so that they can be monitored visually.



Attention! All the Clearing Bearings are synchronized on all the network stations.

Open the **Overlays** panel by selecting the appropriate line of the **Tasks List** menu in the tabs zone of the ECDIS task screen.

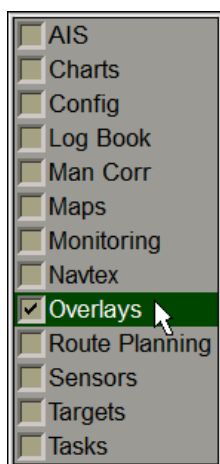

Use the tab in the top part of the **Overlays** panel which will open up, to switch to the **Clearing Bearing** page.

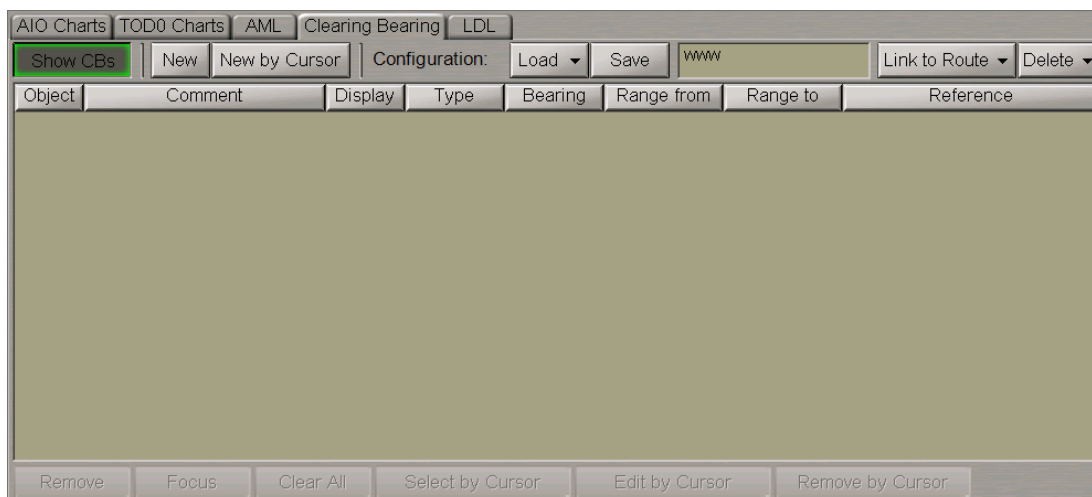

Press the **Show CBs** button to display Clearing Bearings (CBs) on the ECDIS task screen.

Note: The **Show CBs** button on the **Clearing Bearing** page is synchronized with the **Clearing Bearing** checkbox in the **Info Layers** drop-down list on the Control Panel, therefore, its status (on/off) depends on whether this checkbox is checked or not.

Creating Clearing Bearing

Press the **New** button.

In the window which will open up, set the following Clearing Bearing parameters:

1. Select the Clearing Bearing type: Port or Starboard. To do this, press respectively the **Port** or **Stb** button.

Note: Selection of the Clearing Bearing means which bearing to the selected reference point will be safe. When the Port button is pressed, any bearing Not More Than (NMT) the set value will be considered to be safe. When the Stb button is pressed, any bearing Not Less Than (NLT) the set value will be considered to be safe.

2. Use the **Comment** input box to enter necessary comments on the Clearing Bearing.
3. If the Clearing Bearing is required to be referenced to a chart object, check the **Snap** checkbox. In this case, the chart object name will automatically appear in the table **Comment** column.

Warning! It is easier to enter the parameters listed below direct on the chart with the aid of the graphic cursor called by pressing the **Edit by cursor** button. If their values are known in advance, this can be done in the relevant input boxes.

4. Use the **Bearing** input box to enter necessary comments on the Clearing Bearing.
5. Use the **Range start** input box to enter distance from the reference point to the beginning of the Clearing Bearing (cannot be larger than the next value).
6. Use the **Range end** input box to enter the distance from the reference point to the end of the Clearing Bearing.
7. Use the **Reference** input box to enter the reference point coordinates.

To plot the Clearing Bearing on the chart press **Edit by cursor** button.

The acquisition marker  will appear on the Chart Panel, whereas the right bottom part of the screen will display the Select object information window with the cursor coordinates.

Select object point	
Latitude	56°18.993' N
Longitude	017°43.472' E
Ship position	
	true relative
Bearing	221.9 005.5 °
Opp. Bearing	041.9 174.5 °
Range	4.25 NM
	7868 m
Press Tab to edit manually	

Position the acquisition marker in the reference point of the Clearing Bearing and press the left trackball button, the acquisition marker will change its form to the graphic cursor.

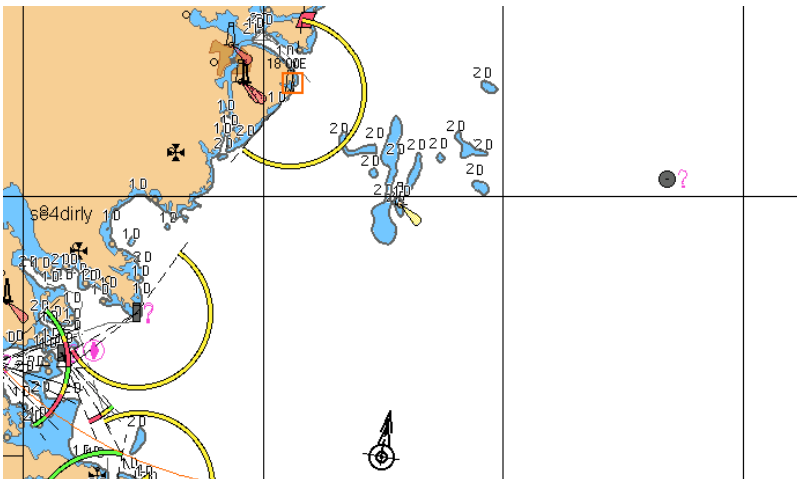

Select the Clearing Bearing reference point and press the left trackball button

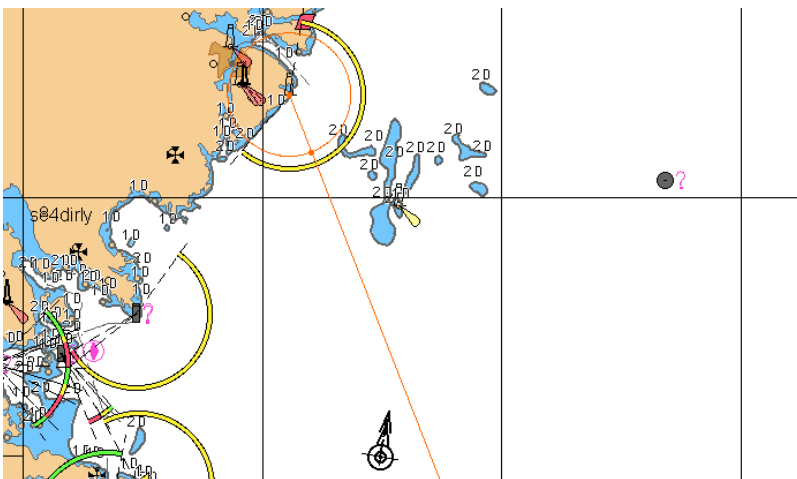

Use the ERBL to set the Start point of the Clearing Bearing line and press the left trackball button.

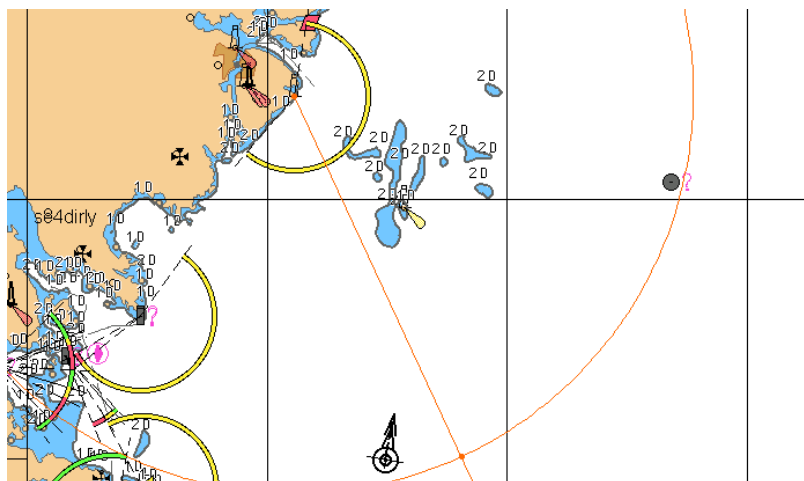

Then set the end point of the Clearing Bearing line and press the left trackball button.

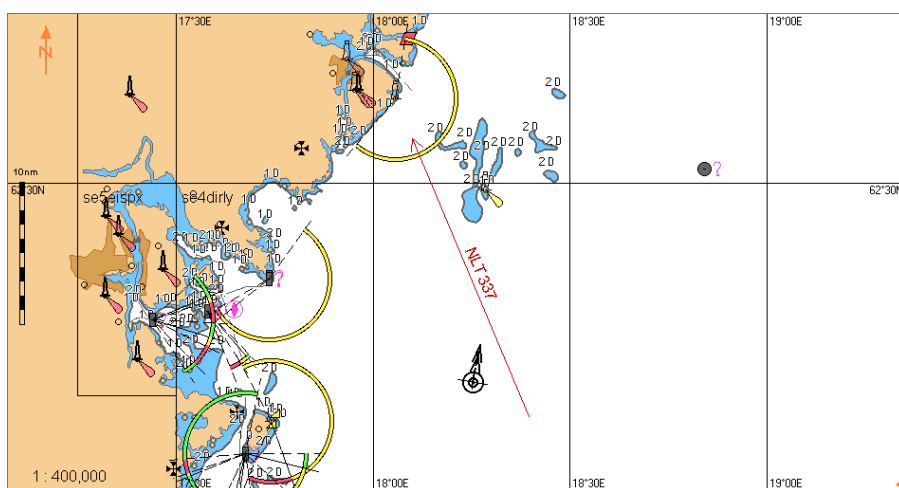

The Clearing Bearing will be set in the specified coordinates on the Chart panel.

The table on the **Clearing Bearing** page shows the Clearing Bearing and its parameters.

AIO Charts TOD0 Charts AML Clearing Bearing LDL

Show CBs New New by Cursor Configuration: Load Save Link to Route Delete

Object	Comment	Display	Type	Bearing	Range from	Range to	Reference
1	Ronehamn	<input checked="" type="checkbox"/>	NLT	337.0°	3.1 NM	24.4 NM	62° 35.975 N, 018° 03.368 E

Remove Focus Clear All Select by Cursor Edit by Cursor Remove by Cursor

You can use an alternative Clearing Bearing creation procedure by pressing the **New by Cursor** button. In this case, the acquisition marker will first appear. Use this marker to plot the Clearing Bearing on the Chart panel as described above, and after the exit from the graphic editing mode, the Clearing Bearing parameters editing window will open up.

Clearing Bearing Editing

The Clearing Bearing editing process can be divided into the editing of the Clearing Bearing and its parameters.

Select the necessary Clearing Bearing from the table. You can also choose the Clearing Bearing on the chart by pressing the **Select by Cursor** button: use the acquisition marker to select the necessary Clearing Bearing, it is then automatically selected in the table.

Edit the following Clearing Bearing parameters:

- **Comment.** Position the cursor on the **Comment** element cell; double click the left trackball button to activate the cell.

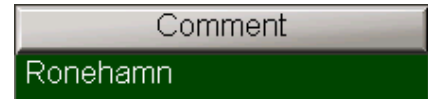

Enter the new comment and press the <Enter> key.

- **Display.** By default, the display on the Chart panel is turned on for all the Clearing Bearings. To turn off the Clearing Bearing display, uncheck the checkbox in the **Display** column.

- **Type.** Click on the **Type** element cell. From the drop-down list, select the necessary Clearing Bearing type (see the previous paragraph).

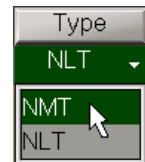

- **Bearing.** Position the cursor on the **Bearing** element cell; double click the left trackball button to activate the cell.



Enter the new bearing and press the <Enter> key.

- **Range from.** Position the cursor on the **Range from** element cell; double click the left trackball button to activate the cell.

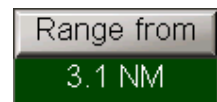

Enter the new distance from the reference point to the beginning of the Clearing Bearing (cannot be larger than the next value) and press the <Enter> key.

- **Range to.** Position the cursor on the **Range to** element cell; double click the left trackball button to activate the cell.

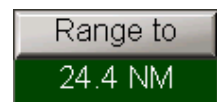

Enter the new distance from the reference point to the Clearing Bearing end and press the <Enter> key.

- **Reference.** The coordinates of the Clearing Bearing reference point cannot be changed at the parameters editing stage.

To edit the Clearing Bearing graphically, press the **Edit by cursor** button.

The  acquisition marker will appear on the Chart panel. Use the acquisition marker to select the necessary Clearing Bearing and press the left trackball button.

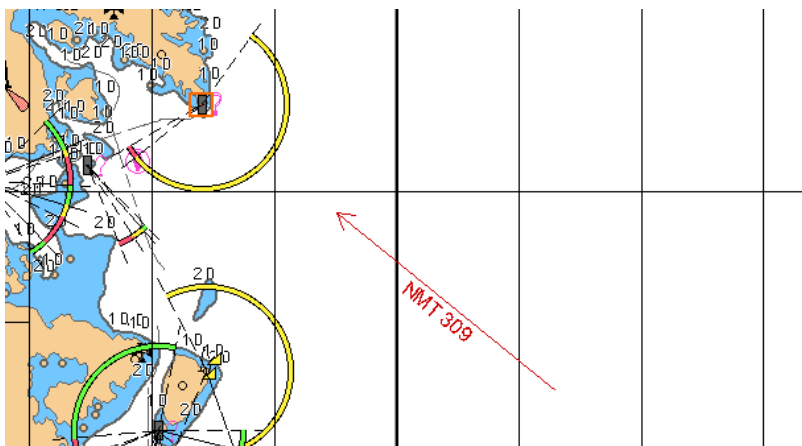

The acquisition marker will be automatically positioned on the Clearing Bearing reference point. Move the acquisition marker to the new reference point as required.

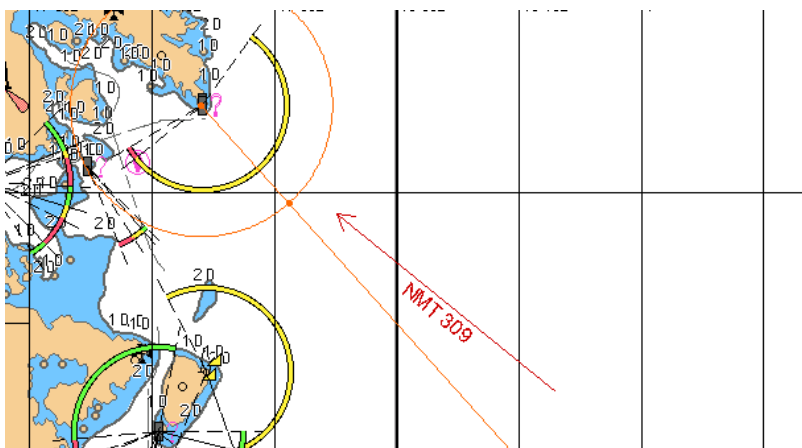

Press the left trackball button. The acquisition marker will turn to the ERBL; use it to set the distance from the reference point to the beginning of the Clearing Bearing line.

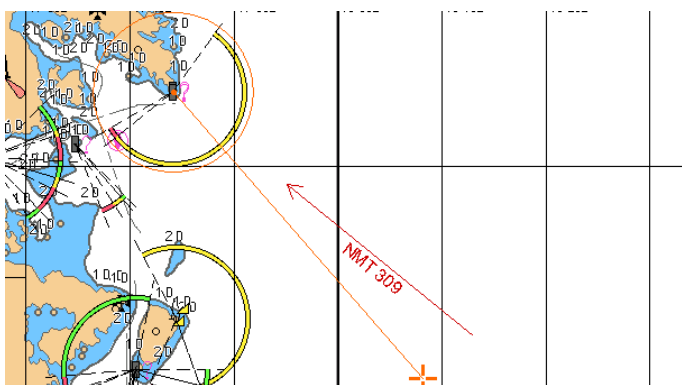

Press the left trackball button and use the ERBL to set the distance from the reference point to the end of the Clearing Bearing line and its new direction. Press the left trackball button.

The Clearing Bearing parameters editing window will open up.

Edit the necessary Clearing Bearing parameters as described above.

Press the **Apply** button to confirm the changes you have made.

Fast Clearing Bearing Search

Use the table on the **Clearing Bearing** page or the cursor (called by pressing the **Select by Cursor** button) to select the necessary object on the Chart panel.

Object	Comment	Display	Type	Bearing	Range from	Range to	Reference
1	Ronehamn	<input checked="" type="checkbox"/>	NMT	319.4°	3.6 NM	16.8 NM	62° 23.292 N, 017° 44.170 E
2	Brumc	<input checked="" type="checkbox"/>	NLT	296.2°	5.2 NM	15.7 NM	62° 10.901 N, 017° 40.340 E
3		<input checked="" type="checkbox"/>	NMT	270.7°	6.5 NM	26.2 NM	62° 00.902 N, 017° 37.141 E

Press the **Focus** button which has been activated.

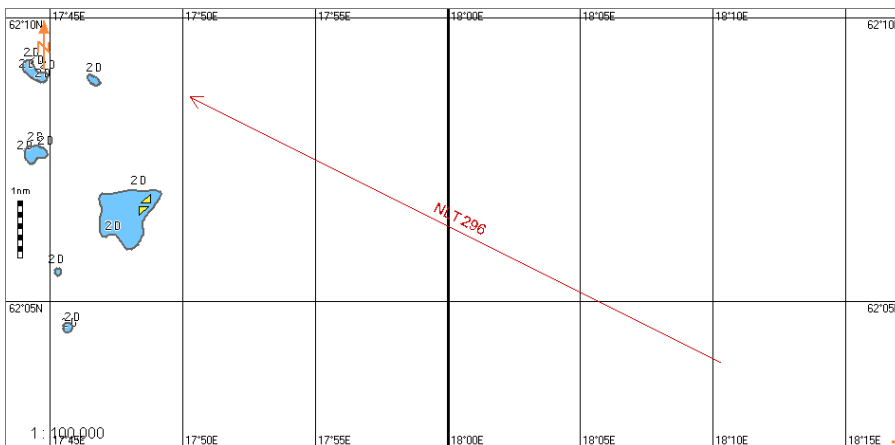

The Chart panel will display the selected Clearing Bearing on the suitable scale chart.

Deleting Clearing Bearing

From the table on the **Clearing Bearing** page select the object to be deleted.

Object	Comment	Display	Type	Bearing	Range from	Range to	Reference
1	Ronehamn	<input checked="" type="checkbox"/>	NMT	319.4°	3.6 NM	16.8 NM	62° 23.292 N, 017° 44.170 E
2	Brumc	<input checked="" type="checkbox"/>	NLT	296.2°	5.2 NM	15.7 NM	62° 10.901 N, 017° 40.340 E
3		<input checked="" type="checkbox"/>	NMT	270.7°	6.5 NM	26.2 NM	62° 00.902 N, 017° 37.141 E

Remove Focus Clear All Select by Cursor Edit by Cursor Remove by Cursor

Press the **Remove** button which has been activated.

To delete a Clearing Bearing with the aid of the cursor, press the **Remove by Cursor** button.

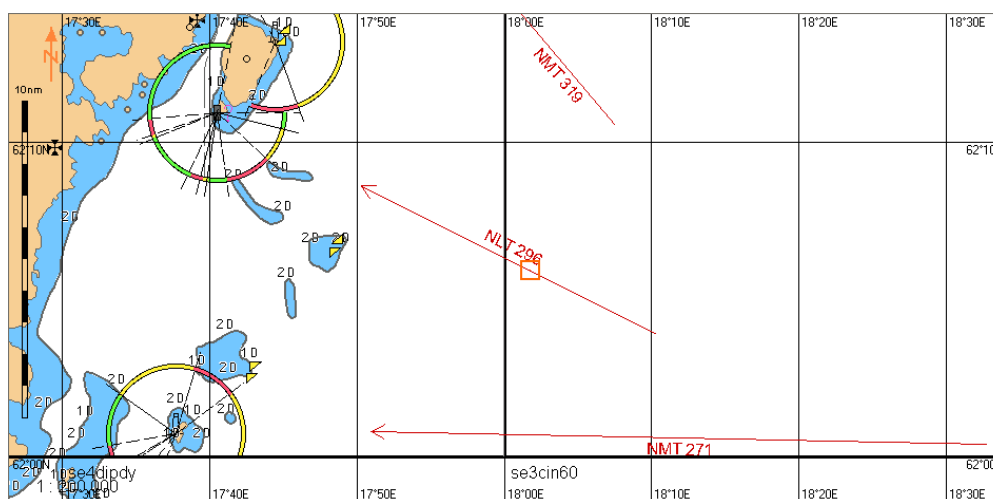

The acquisition marker will appear on the Chart panel. Use the marker to select the Clearing Bearing which should be deleted and press the left trackball button.

To delete all the Clearing Bearings, press the **Clear All** button.

Saving and Loading Configuration

There is a capability to save, load and delete configurations for Limiting Danger Line and Clearing Bearings; this operation is performed in the **Configuration** group on a relevant page.

Create the necessary configuration. To save the configuration, enter the configuration name in the input line of the **Configuration** group.

Configuration: Load Save North Botnic Link to Route Delete

Press the **Save** button which will be enabled. The saved configuration will include all the objects of this page.

To link a configuration to the existing route, press the **Link to Route** button.

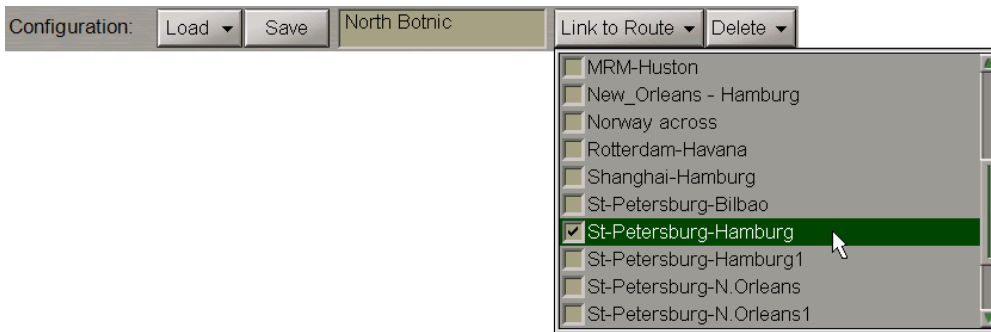

From the drop-down list, select the necessary route. Press the **Save** button.

Note: When the route is loaded for monitoring, this configuration will be automatically loaded.

To load a configuration, press the **Load** button.



From the drop-down list, select the necessary configuration.

To delete a configuration press the **Delete** button.



From the drop-down list, select the necessary configuration.

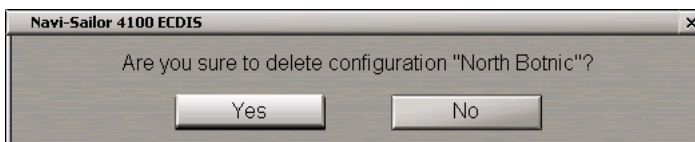

Press the **Yes** button to confirm the deleting.

The configuration files are accessible with the use of the Data Tool utility, in the **Configs** group of the **Clearing Bearing** feature, and can be imported/exported from/to another PC.

Monitoring of Navigational Alerts



Attention! Setting parameters for navigational alerts is available only at station with the status MASTER.

Open **Monitoring** panel by selecting the appropriate line of **Tasks List** menu in the tabs zone of the ECDIS task screen.

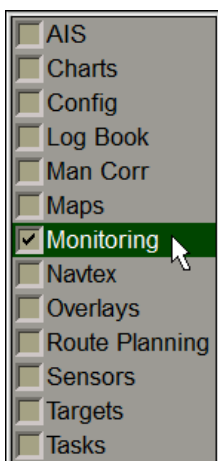

Use the tab in the top part of **Monitoring** panel, which will open up, to switch to **Navigational Alerts** page.

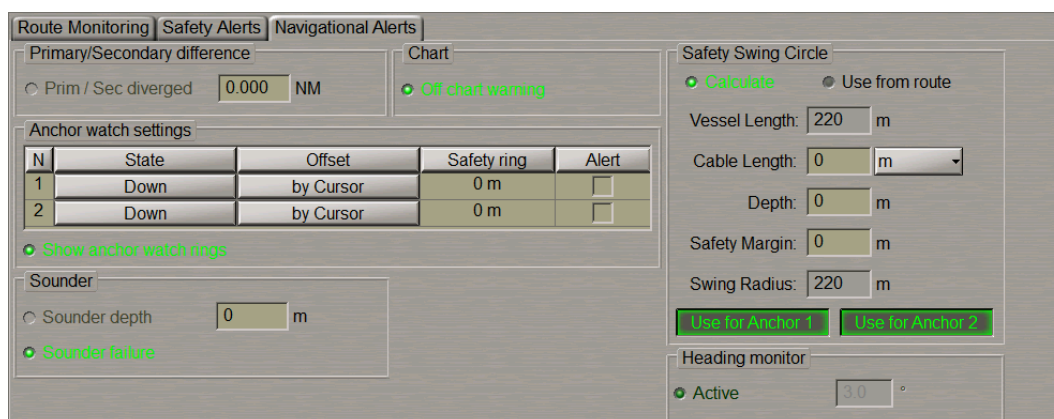

Primary/Secondary difference group is used for entering the maximum difference between the readings of positioning systems, and for turning on their monitoring.

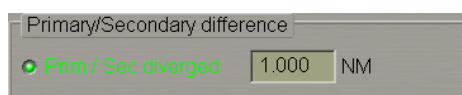

In **Prim/Sec diverged** line, enter the divergence distance between the coordinates from the primary and secondary positioning methods. Check the activated **Prim/Sec diverged** checkbox for the warning to be generated when the set value is exceeded.

The **Chart** group is used for turning on the monitoring of electronic charts under the own ship.



Check the **Off chart warning** checkbox to enable the warning generation if the ship sails beyond the chart boundary with the Chart Autoload mode off.

Anchor watch setting group is used for setting the maximum distance (safety ring) from the anchor points. As the ship moves beyond any of the formed circles, a warning is generated.

Anchor watch settings				
N	State	Offset	Safety ring	Alert
1	Down	by Cursor	0 m	<input type="checkbox"/>
2	Down	by Cursor	0 m	<input type="checkbox"/>

Show anchor watch rings

In **Safety ring** column enter the maximum distance (Safety ring radius) from the anchor points 1 and 2. Position of anchor points 1 and 2 is set on the ship contour during the installation in the System Configuration utility. (see document *Multi-Functional Display. (v. 3.00.340). Installation Guide Part I, Chapter 2, section MFD Configuration , paragraph MFD Settings)*

Check the checkboxes in **Alert** column to turn on the warning generation as the ship sails beyond the set distances.

Check the **Show anchor watch rings** checkbox to show the anchor watch rings around the anchor position after the anchor drop points are set.

To set the position of 1 anchor, press the **Down** button in the row 1.

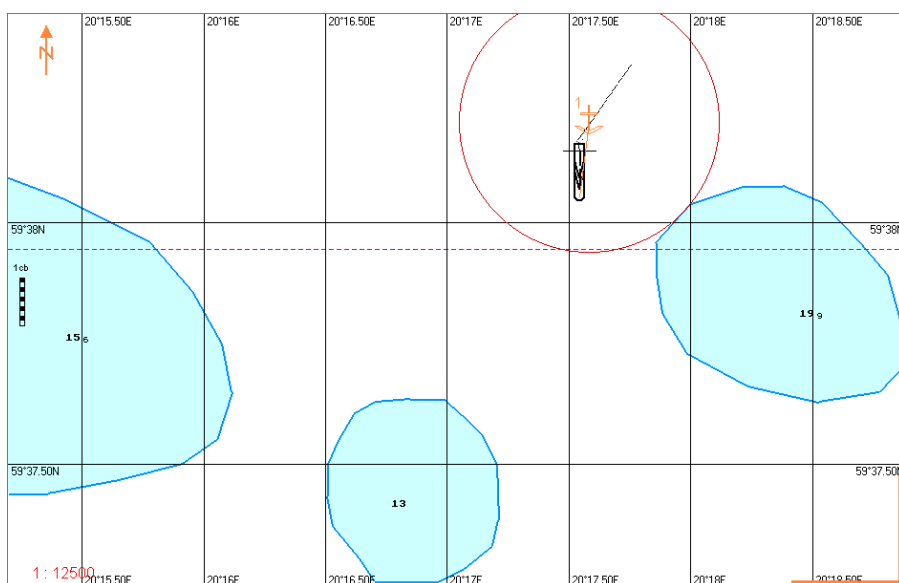

In this case, the anchor position will correspond to the position of anchor point 1 at the moment when the **Down** button is pressed. The anchor position is marked with a special symbol .

Along the line connecting the positions of the anchor and anchor point 1, bearing and distance between them is dynamically displayed.

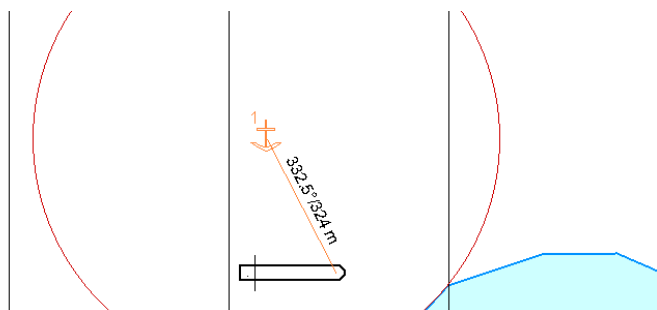

To set the anchor position, use the cursor to press the **By Cursor** button in row 1. Indicate the anchor position with the cursor on the Chart Panel.

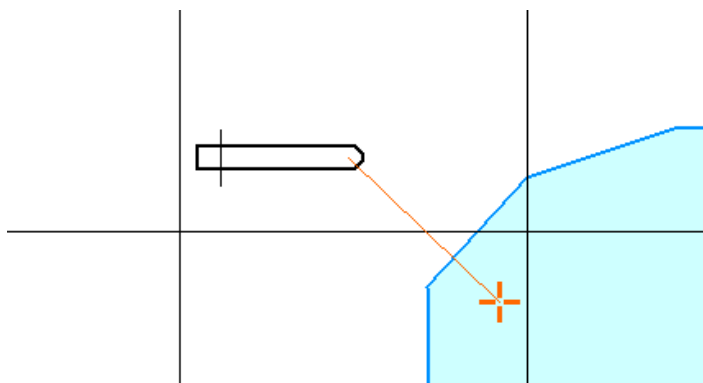

Press the left trackball button.

Use similar procedures if it is necessary to set anchor 2.

Press the left trackball button.

Sounder group is used for turning on monitoring of the echo sounder readings and contains the following checkboxes:

- **Sounder depth** – to enable and enter the minimum depth value for an alert generated upon the reception of data from the echo sounder;
- **Sounder failure** – to enable/disable **Sounder: no input** caution.

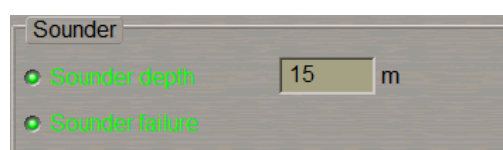

Use **Sounder depth** line to enter the safety depth value from the echo sounder. Check the activated **Sounder depth** checkbox for turning on the alert generation as a depth smaller than the set one is detected.

Monitoring of Time

Open **Config** panel by selecting the appropriate line of **Tasks List** menu in the tabs zone of the ECDIS task screen.

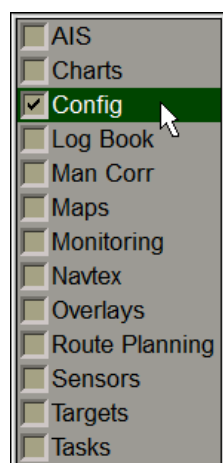

Use the tab in the top part of **Config** panel, which will open up, to switch to **General** page.

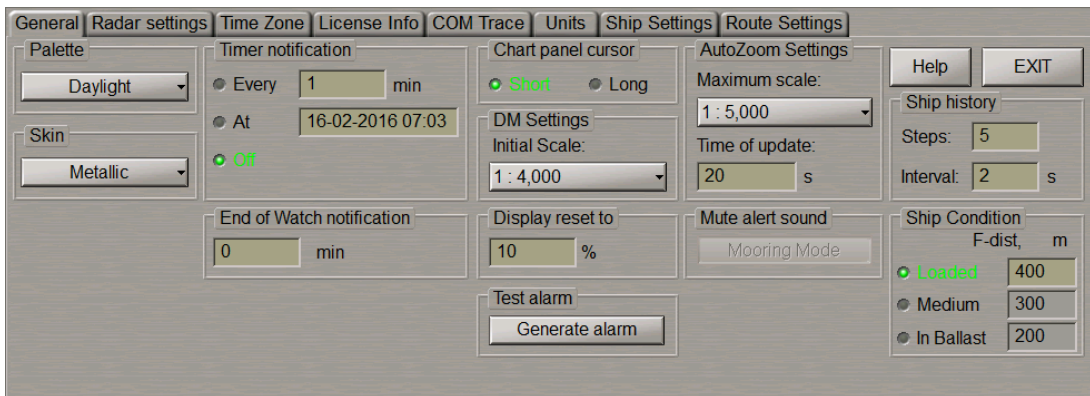

Setting of End-of-Watch Alerts

End of Watch Caution group is intended for setting the period of time before the end of the current watch when an alert will be generated. The order of watches is set in the System Configuration utility (see document *Multi-Functional Display (v. 3.00.340). Installation Guide Part I, Chapter 2, section MFD Configuration, paragraph MFD Settings*).

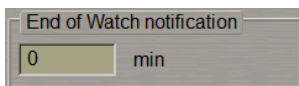

Use End of Watch notification input line to enter the time before the end of the current watch when the notification should be generated.

Setting of the Timer

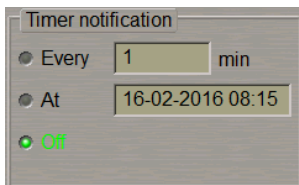

Timer notification group is designed for the control of the timer functions:

- **Every** – setting of the notification to be generated over the time specified in the line to the right;
- **At** – setting of the notification to be generated at the time specified in the line to the right;
- **Off** – to turn off timer functions.

To set the notification generation over equal time intervals, check **Every** checkbox and enter value of the notification generation time interval in the input line.

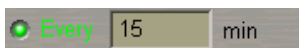

To set the notification generation at the certain time, check **At** checkbox and enter the notification generation time (ship time) to the right.

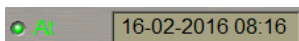

Chapter 6.

Using Logging Functions

This chapter describes the procedure used for handling information archived in the course of the MFD operation.

<u>Using Ship Logbook</u>	178
User Accounts Creation	179
Search for Events in Ship LogBook	181
Events Filtering	182
Custom Events Creation	183
Event Entering and Editing	185
The Ship Logbook Editing	191
Separating Voyages	192
<u>Work with Archive</u>	194
<u>Ship Logbook Printout</u>	196
<u>Using Electronic System Logbook</u>	200
<u>Own Ship Track in the ECDIS Task</u>	204
Setting Track Display Elements	204
Viewing Archive Tracks	207

Using Ship Logbook

Open **Logbook** panel by selecting the appropriate line of **Tasks List** menu in the tabs zone of the ECDIS task screen.

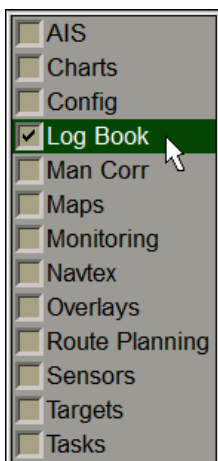

Use the tab in the top part of **Logbook** panel, which will open up, to switch to **LogBook** page.

 The screenshot shows the 'Ship LogBook' panel. At the top, there are tabs for 'Ship LogBook', 'Archive', 'System Log', and 'Logbook settings'. Below the tabs, there are controls for 'Dates' (set to 16-10-2013), 'Focus', 'Filter...', 'Position interval' (set to 60 min), 'Start voyage', and 'Enter Event ...'. The main part of the panel is a table with the following columns: Time Local, Event, LAT LON, Source, Chart Track, GYRO (ERR), MAG (ERR), Press. hPa, Temp. air, °C sea, °C, Wind dir. speed, m/s, DIST., NM by LOG, SMG, and RPM. The table contains several rows of data, with the first row highlighted in green. Below the table, there is a 'Comment' field with a 'History list' button and an 'Edit' button.

Time Local	Event	LAT LON	Source	Chart Track	GYRO (ERR)	MAG (ERR)	Press. hPa	Temp. air, °C sea, °C	Wind dir. speed, m/s	DIST., NM by LOG, SMG	RPM
12:56:21 (04:00 E)	Chart	57° 31.766 N 019° 42.958 E	GPS1 GYRO1	226.4°	216.5° +0.0	216.5° +0.0	***	18.0 18.0	119.9° 10.0	15.2 16.7	***
12:49:06 (04:00 E)	Out of XTD	57° 32.251 N 019° 43.627 E	GPS1 GYRO1	226.3°	216.5° +0.0	216.5° +0.0	***	18.0 18.0	119.9° 10.0	14.6 15.8	***
12:48:55 (04:00 E)	New track	57° 32.264 N 019° 43.644 E	GPS1 GYRO1	226.3°	216.5° +0.0	216.5° +0.0	***	18.0 18.0	119.9° 10.0	14.6 15.8	***

Ship LogBook page is designed for recording events which occurred during the ECDIS task operation and their synchronizing among the stations. The table is a set of rows (events) and of columns (event parameters). For the set of events which are automatically shown in the Ship Logbook, see *Multi-Functional Display (v. 3.00.340). Functional Description, Chapter 6, section Ship Logbook, paragraph Ship Logbook Formation Principles*. Besides, the operator can enter events manually, edit events and enter comments on the events. The events editing and input of comments is password protected.

Note: The Ship LogBook always opens up on the current date

User Accounts Creation

Before starting work with the Ship LogBook, it is necessary to create user accounts. Account attributes are used as a digital signature when an event is entered or edited in the Ship log book. The user who has no own account can only read the Ship LogBook.

Open **Logbook** panel by selecting the appropriate line of **Tasks List** menu in the tabs zone of the ECDIS task screen.

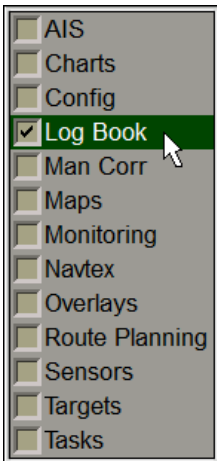

Use the tab in the top part of **Logbook** panel, which will open up, to switch to **Logbook settings** page. On the **Logbook settings** page switch to **Logbook accounts** tab.

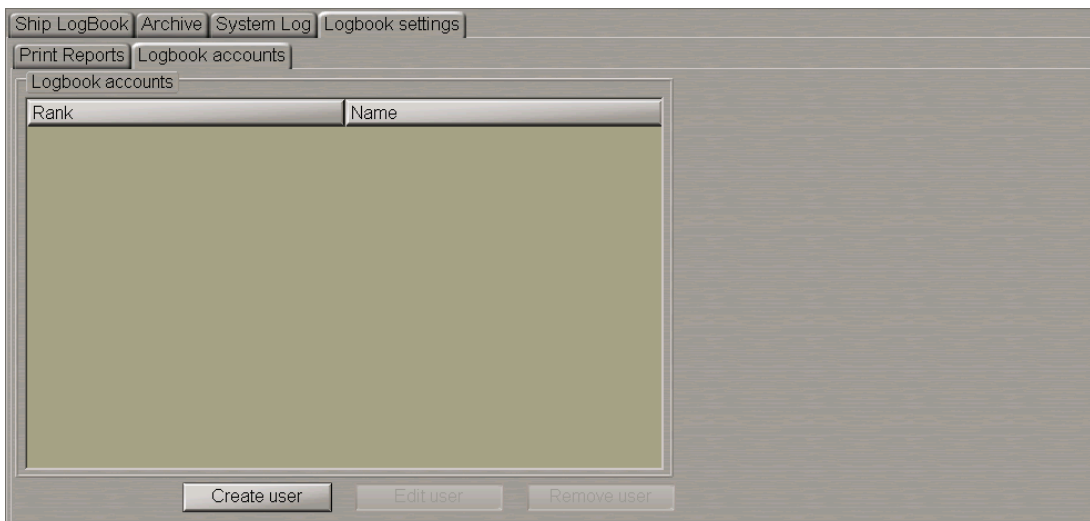

This tab is intended for creating accounts for the Ship Logbook only. Accounts which are created in the System Configuration utility are only used for deleting accounts from the Ship Logbook.

To create a new user account press **Create user** button.

In a special window the user should enter the following parameters:

- Rank. The user can select one of the offered ranks or specify his/her own (i.e., “Master”);
- Name;
- Password (special symbols like space, points, etc. are not permitted. When these are entered, there is a message that unacceptable symbols have been entered);
- Password confirmation;
- Security question for restoring the forgotten password. At the account creation stage the operator can select any question and answer it in the *Answer* field;
- Answer for Security question.

The rank and name combination will serve as the user account.

Rank	Name
Captain	Den Brown
Captain	Jack Short
2nd officer	Jack Sparrow
Chief officer	Sebastian Pereira
3rd officer	William Kidd

To change the user account (rank, name, password) select it from the table and press **Edit user** button.

Enter the “password” for the relevant currently edited user account and edit it.

To remove a user account press the **Remove user** button. The deleting password is advised by the MFD distributor upon the master's request.



In the password-protected operations, the password input box has been supplemented with the **Forgot?** button. This button is intended for restoring a forgotten password. Press this button to open a dialogue box in which use the **Your answer** field to enter an answer to the Security question (set at the account creation stage). If the reply is entered correctly, the **Your password** field will display a password set by the operator at the account creation stage.

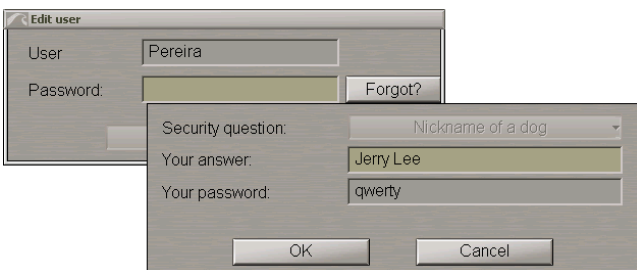

Press the **Ok** button, the password will be automatically applied to the **Edit user** window.

The **Security question** and **Your password** fields are not editable in this window.

Account parameters are stored on the all WS of the bridge.

Search for Events in Ship LogBook

Note: The **Ship LogBook** page stores date-by-date events for the last 90 days, whereupon the events are moved to the archive.

Press the **Date** button and select the date which the Ship Logbook entries will be shown for.

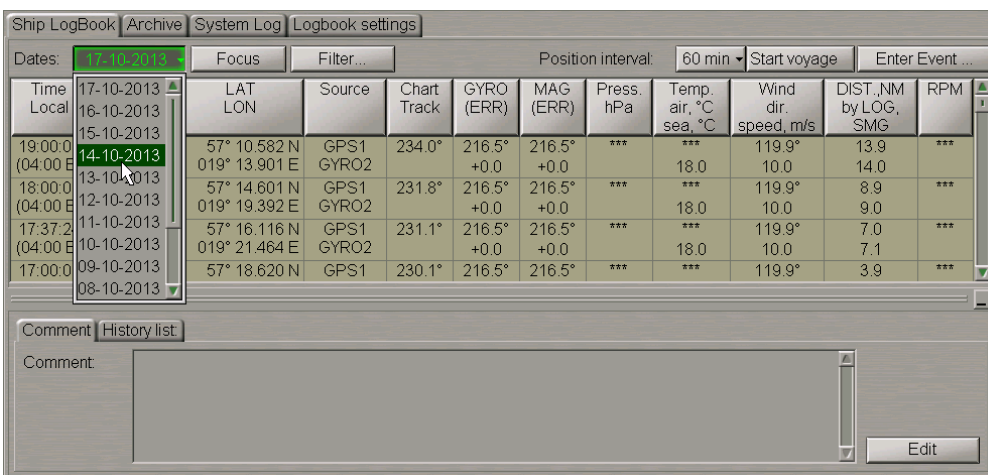

When a date is selected, the drop-down list opens up showing the events which occurred within the selected 24 hour. Select the necessary event. The **Comment** tab will display the last actual comment related to this event.

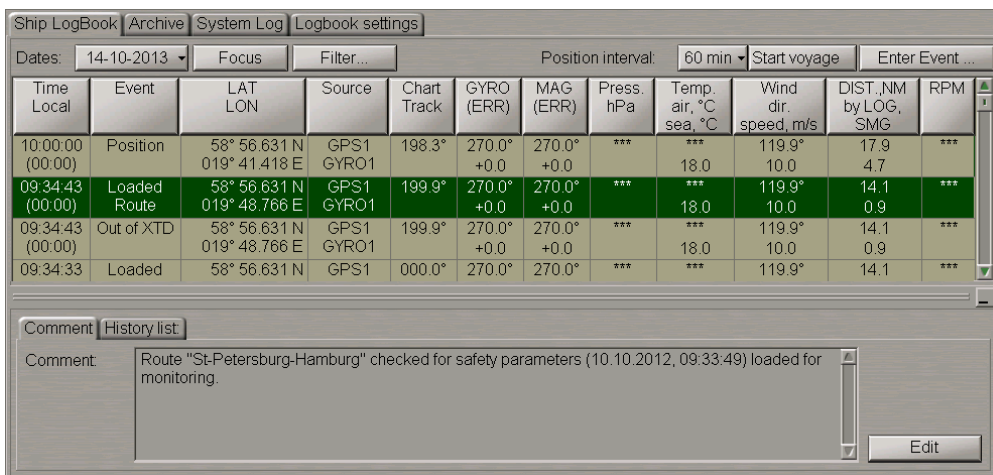

To display the event position, on the Chart panel press the **Focus** button.



The selected event mark is displayed in the centre of the Chart panel highlighted with a flashing circle for 10 seconds.

Events Filtering

To filter the display of events in the Ship Logbook, press the **Filter** button in the top part of the page.

Note: Filtering is only possible for events entered by the operator manually (default and custom).

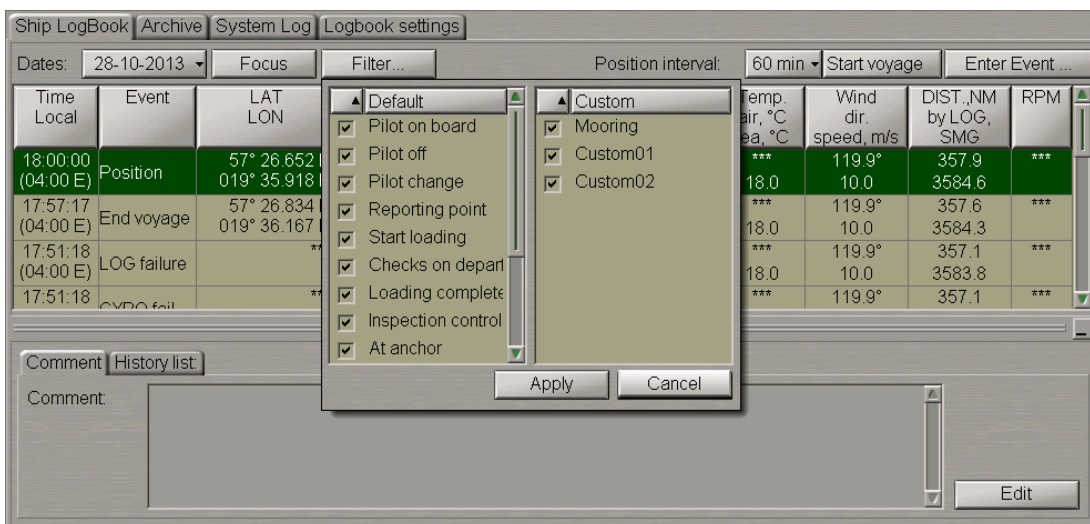

Turned on by default is the display of all default and custom events available in the **Enter Event** control. When a new custom event is created it automatically becomes available in the **Filter** drop down list.

To turn off the display of some events, uncheck relevant checkboxes next to the names of these events.

To select all the events, press the right trackball button and choose the **Select all** menu item.

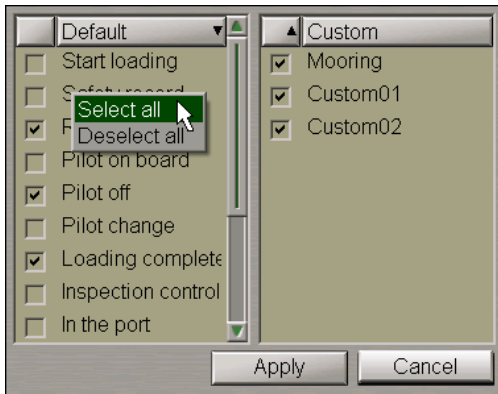

To cancel selection of all the previously selected events, choose the **Deselect all** menu item.

Events can also be sorted by alphabet which is done by pressing on the name of the **Default/Custom** column.

Press the **Apply** button.

If display of some of the events was disabled, the "*" symbol appears on the button.



Custom Events Creation

In the Ship LogBook, there is a list of default events. The user can create own custom events as required, which can be recorded in the Ship LogBook.

Note: Custom Events can only be entered on a WS with the backup-0 and backup-1 priority, see also document *Multi-Functional Display (v. 3.00.340). Functional Description, Chapter 6, section Ship Logbook, paragraph Ship Logbook Formation Principles.*

Press the **Enter Event** button.

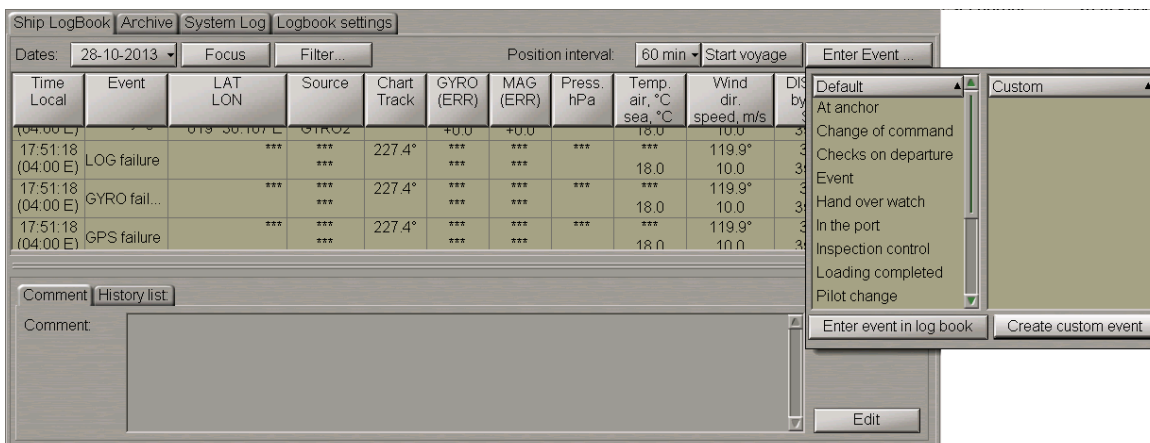

In the window, which will open up, press **Create custom event** button.

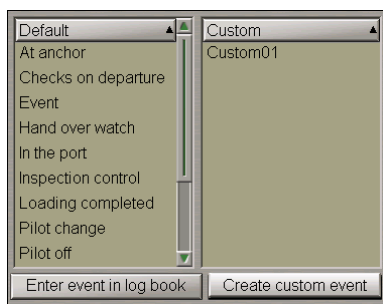

The event with the name “CustomXX” will appear on the **Custom** list. The created custom event is synchronized automatically among the stations of the bridge.

Edit the event name. To do this, double click the event name.

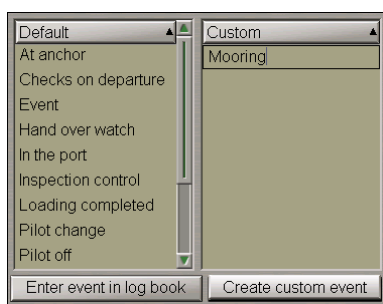

Type the necessary event name and press the left trackball button.

To add and edit a new custom event, you can also use the context menu called by clicking the right mouse button.

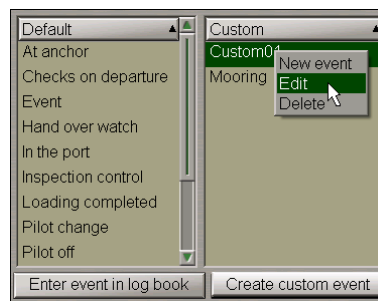
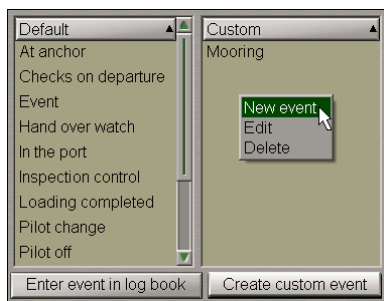

To delete a custom event, select it and press the right trackball button.

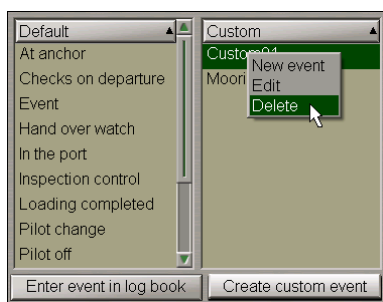

From the drop-down list select **DELETE** item.

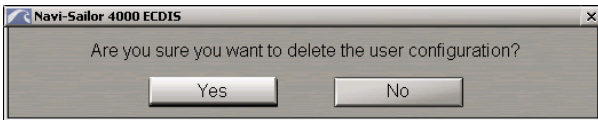

Press **OK** button.

To exit from the window, click the cursor in the point on the ECDIS task screen.

Event Entering and Editing

The event **Position** is entered in the Ship Logbook automatically, by default the 60 min interval is set. To set the required interval, press the **Position Interval** button.

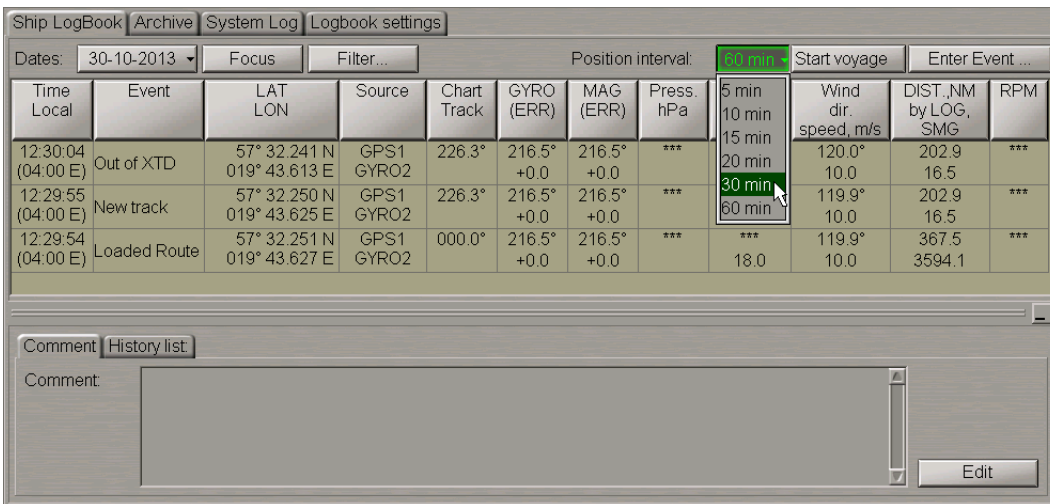

Select the necessary time period. The selected setting is synchronised automatically among the stations of the bridge.

To manually enter an event in the Ship Logbook, press the **Enter Event** button.

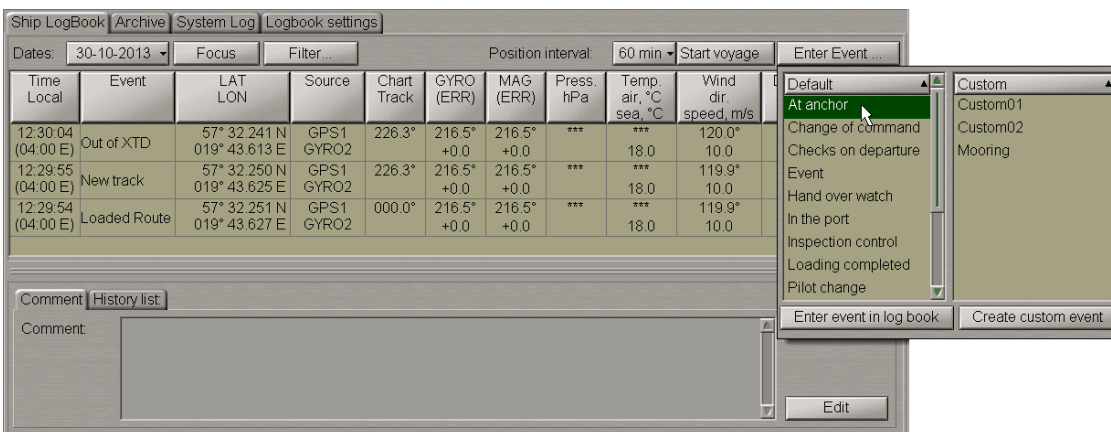

Select the necessary event from the **Default** or **Custom** list boxing press **Enter event in log book** button. All events from these lists can be sorted in alphabetical order.

In the **User accounts** window which will appear, in **Comment** input box enter the comments on the event. Each event is recorded manually in the Ship Log Book required to enter a personal password, the rank and name of the operator who entered the event. From the **User** drop-down list In the **User accounts** window which will appear, select your user account and enter the password (user accounts and password settings are made in **Logbook accounts** tab of **Logbook settings** page see above item *User Accounts Creation*).

Press the **OK** button.

Time Local	Event	LAT LON	Source	Chart Track	GYRO (ERR)	MAG (ERR)	Press. hPa	Temp. air, °C sea, °C	Wind dir. speed, m/s	DIST. NM by LOG, SMG	RPM
12:37:53 (04:00 E)	At anchor	57° 31.686 N 019° 42.847 E	GPS1 GYRO2	226.4°	216.5° +0.0	216.5° +0.0	***	*** 18.0	119.9° 10.0	203.5 17.2	***
12:35:07 (04:00 E)	Chart	57° 31.903 N 019° 43.146 E	GPS1 GYRO2	226.4°	216.5° +0.0	216.5° +0.0	***	*** 18.0	119.9° 10.0	203.3 17.0	***
12:30:04 (04:00 E)	Out of XTD	57° 32.241 N 019° 43.613 E	GPS1 GYRO2	226.3°	216.5° +0.0	216.5° +0.0	***	*** 18.0	120.0° 10.0	202.9 16.5	***
12:29:55	New track	57° 32.250 N	GPS1	226.3°	216.5°	216.5°	***	***	119.9°	202.9	***

Comment: 6 shackles in the water.

The event is shown in the Ship Logbook. The data available in the table columns as of the event occurrence time are shown in the Ship Logbook automatically.

To view the history of an event /comment entered for this event, switch to the **History list** tab.

Time Local	Event	LAT LON	Source	Chart Track	GYRO (ERR)	MAG (ERR)	Press. hPa	Temp. air, °C sea, °C	Wind dir. speed, m/s	DIST. NM by LOG, SMG	RPM
12:37:53 (04:00 E)	At anchor	57° 31.686 N 019° 42.847 E	GPS1 GYRO2	226.4°	216.5° +0.0	216.5° +0.0	***	*** 18.0	119.9° 10.0	203.5 17.2	***
12:35:07 (04:00 E)	Chart	57° 31.903 N 019° 43.146 E	GPS1 GYRO2	226.4°	216.5° +0.0	216.5° +0.0	***	*** 18.0	119.9° 10.0	203.3 17.0	***
12:30:04 (04:00 E)	Out of XTD	57° 32.241 N 019° 43.613 E	GPS1 GYRO2	226.3°	216.5° +0.0	216.5° +0.0	***	*** 18.0	120.0° 10.0	202.9 16.5	***

Comment History list

Created by: **Captain Jack Short**

Edited by: **2nd officer Jack Sparrow** [30/10/13 08:41:01]

Comment: - Changed from:
6 shackles in the water.
Changed to:
7 shackles in the water.

There are some slight differences in the procedure of entering the **Hand over watch** event in which both navigators take part: officers going off and on the watch.

Press the **Enter Event** button.

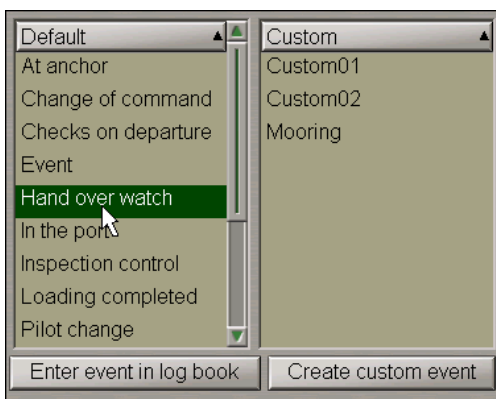

Select the **Hand over watch** event from the **Default** list boxing and press **Enter event in log book** button.

From the **User** drop-down list in the **Hand over watch** window which will appear, the officer going off the watch selects his/her user account and enters the password.

Hand over watch

For hand over watch please specify your password.

User: Chief officer Pereira

Password: ****

Press the **OK** button.

From the **User** drop-down list in the **Hand over watch** window which will appear, the officer going on the watch selects his/her user account and enters the password.



Hand over watch

For hand over watch please specify your password.

User: 2nd officer Sparrow

Password: ****

Forgot?

OK Cancel

Press the **OK** button.

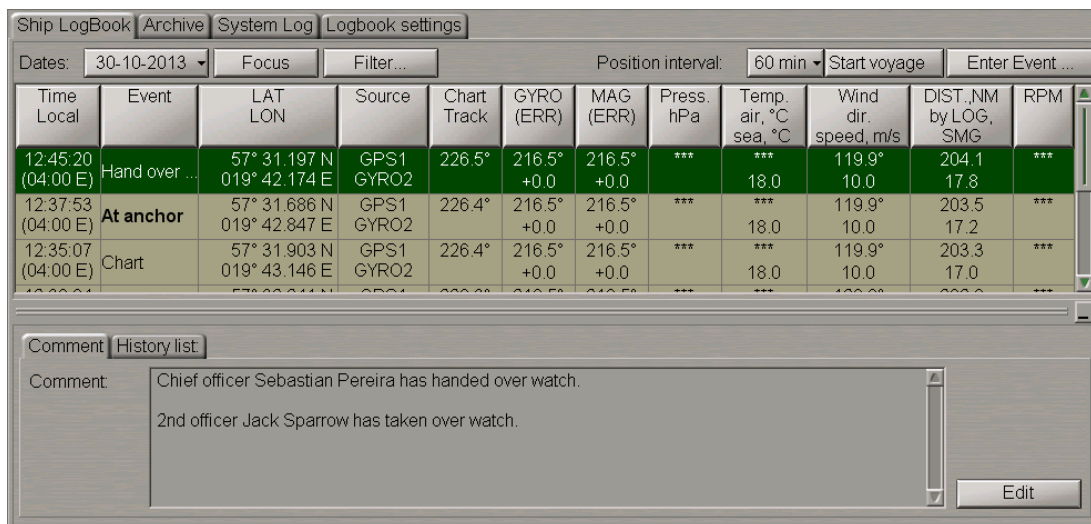

Ship LogBook Archive System Log Logbook settings

Dates: 30-10-2013 Focus Filter... Position interval: 60 min Start voyage Enter Event ...

Time Local	Event	LAT LON	Source	Chart Track	GYRO (ERR)	MAG (ERR)	Press. hPa	Temp. air, °C sea, °C	Wind dir. speed, m/s	DIST.,NM by LOG, SMG	RPM
12:45:20 (04:00 E)	Hand over ...	57° 31.197 N 019° 42.174 E	GPS1 GYRO2	226.5°	216.5° +0.0	216.5° +0.0	***	*** 18.0	119.9° 10.0	204.1 17.8	***
12:37:53 (04:00 E)	At anchor	57° 31.686 N 019° 42.847 E	GPS1 GYRO2	226.4°	216.5° +0.0	216.5° +0.0	***	*** 18.0	119.9° 10.0	203.5 17.2	***
12:35:07 (04:00 E)	Chart	57° 31.903 N 019° 43.146 E	GPS1 GYRO2	226.4°	216.5° +0.0	216.5° +0.0	***	*** 18.0	119.9° 10.0	203.3 17.0	***

Comment History list

Comment Chief officer Sebastian Pereira has handed over watch.
2nd officer Jack Sparrow has taken over watch.

Edit

The event is shown in the Ship Logbook. The **Comment** tab will display information on the person going off/on the watch.

For rules for the input and display of comments in the Ship Logbook, see document *Multi-Functional Display (v. 3.00.340). Functional Description, Chapter 6, section Ship Logbook, paragraph Making Corrections and Safety.*

It is in much the same way that the **Change of command** event is entered, in which both masters take part. This event serves for denoting the account of which master is currently active, i.e., who is in command of the ship at each particular moment of time.

Press the **Enter Event** button.

Select the **Change of command** event from the **Default** list boxing and press the **Enter event in log book** button.

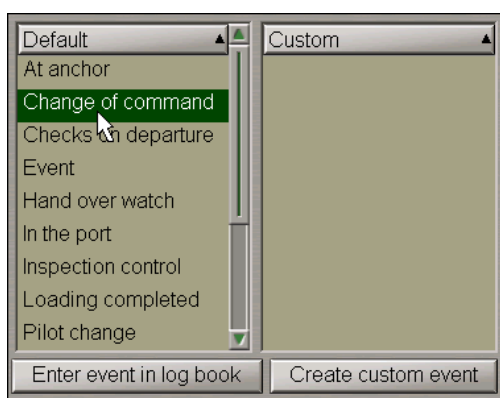

Default Custom

- At anchor
- Change of command
- Checks in departure
- Event
- Hand over watch
- In the port
- Inspection control
- Loading completed
- Pilot change

Enter event in log book Create custom event

The master who is passing the command enters his/her password.

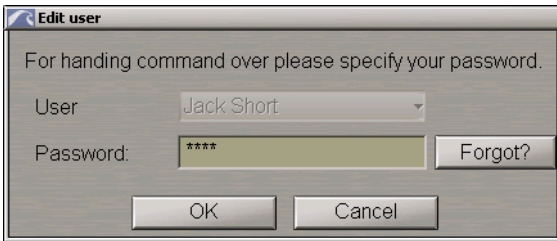

Edit user

For handing command over please specify your password.

User: Jack Short

Password: ****

Forgot?

OK Cancel

Press the **Ok** button.



Select user

For taking command over please specify your password.

User: Select user

Password: Captain Den Brown

Forgot?

OK Cancel

From the **User** drop-down list in the **Select user** window which will appear, the master assuming the command selects his/her user account and enters the password.



Select user

For taking command over please specify your password.

User: Captain Den Brown

Password: ****

Forgot?

OK Cancel

Press the **Ok** button.

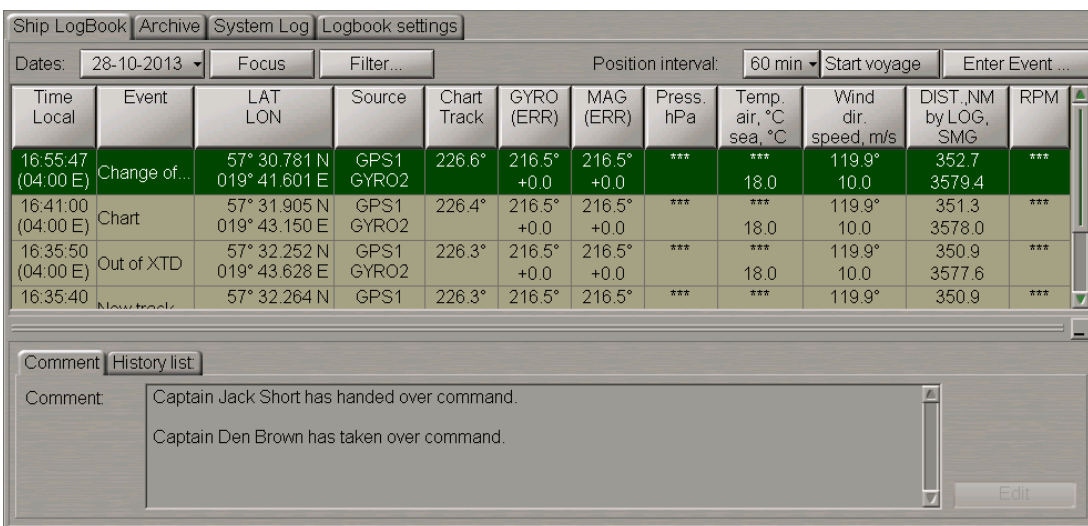

Ship LogBook Archive System Log Logbook settings

Dates: 28-10-2013 Focus Filter... Position interval: 60 min Start voyage Enter Event ...

Time Local	Event	LAT LON	Source	Chart Track	GYRO (ERR)	MAG (ERR)	Press. hPa	Temp. air, °C sea, °C	Wind dir. speed, m/s	DIST.,NM by LOG, SMG	RPM
16:55:47 (04:00 E)	Change of...	57° 30.781 N 019° 41.601 E	GPS1 GYRO2	226.6°	216.5° +0.0	216.5° +0.0	***	*** 18.0	119.9° 10.0	352.7 3579.4	***
16:41:00 (04:00 E)	Chart	57° 31.905 N 019° 43.150 E	GPS1 GYRO2	226.4°	216.5° +0.0	216.5° +0.0	***	*** 18.0	119.9° 10.0	351.3 3578.0	***
16:35:50 (04:00 E)	Out of XTD	57° 32.252 N 019° 43.628 E	GPS1 GYRO2	226.3°	216.5° +0.0	216.5° +0.0	***	*** 18.0	119.9° 10.0	350.9 3577.6	***
16:35:40	New track	57° 32.264 N	GPS1	226.3°	216.5°	216.5°	***	***	119.9°	350.9	***

Comment History list

Comment: Captain Jack Short has handed over command.
Captain Den Brown has taken over command.

Edit

The event is shown in the Ship Logbook. The **Comment** tab will display information on the person who has passed/assumed the command. Comments on this event cannot be edited, the **Edit** button is disabled.

If during the creation of the **Change of command** event, in the **Logbook accounts** tab there is not a single user with the "Captain" rank, a press on the **Enter event in log book** button, will display the **Select user** window:

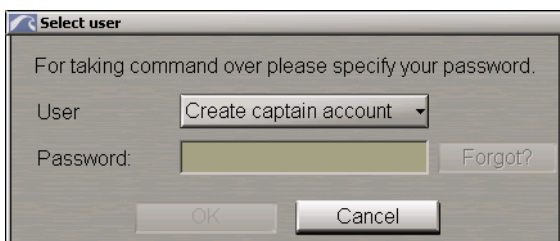

Press the **Create captain account** button. The **Logbook accounts** tab will open on the **Logbook settings** page. Use this tab to create a new captain account as described in *User Accounts Creation* paragraph (see above). Then run the procedure for creating the **Change of command** event anew.

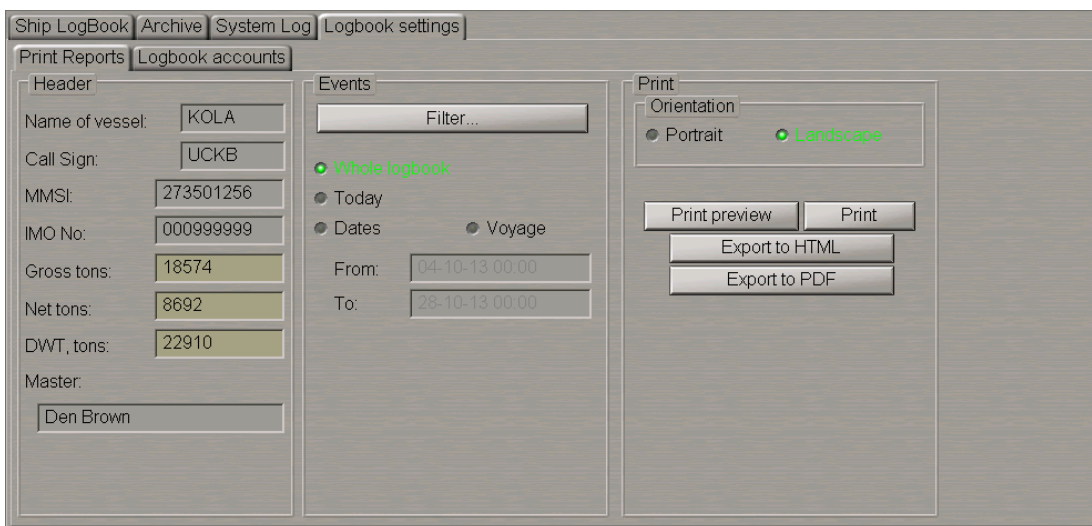

The name of the master who has assumed the command is automatically entered in the **Master** box in the **Print Settings** tab on the **Logbook settings** page of the **Logbook** panel (see section *Ship Logbook Printout*).

If the active master's account is deleted, the **Change of command** event with an appropriate comment will be automatically entered in the Ship Logbook:

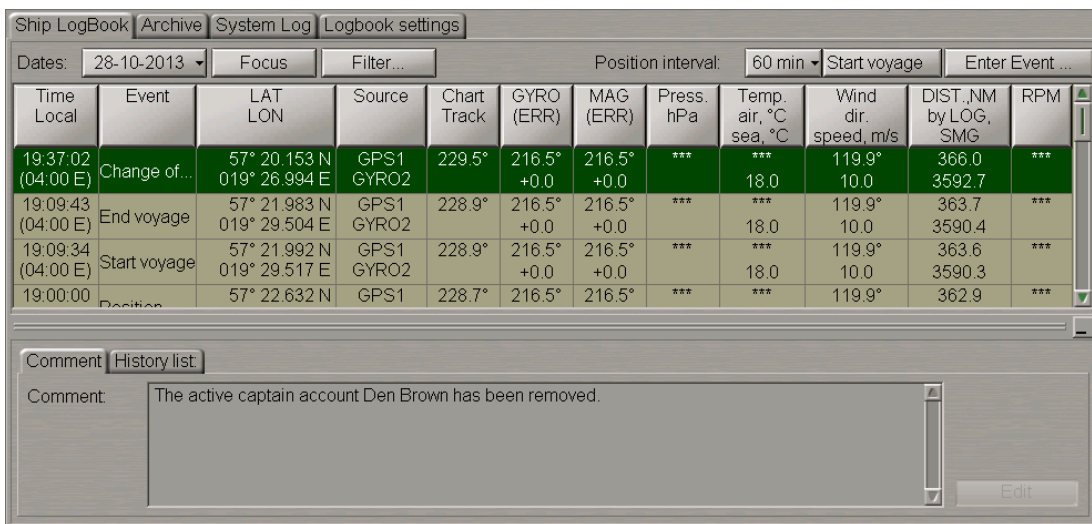

The Ship Logbook Editing

The Ship Logbook enables editing of the event parameters from Chart Track to RPM columns only. Use the trackball to position the cursor on the cell which should be edited and make a double left click.

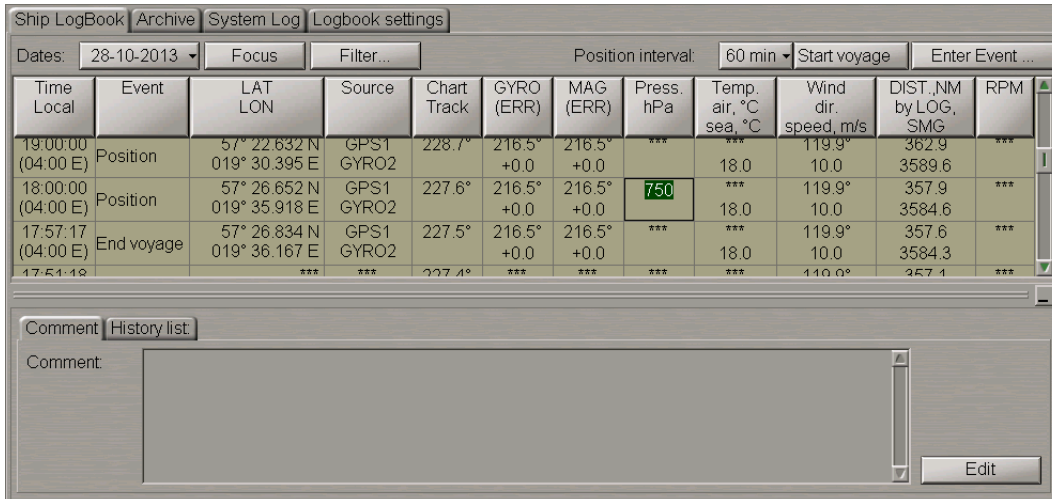

Roll the trackball or use the keyboard to enter the necessary value and press the left trackball button or the <Enter> key. To cancel input of the correction, press the right trackball button.

In the **User accounts** window which will appear, enter the comment (if necessary), select your user account and enter the password (user accounts and password settings are made in **Logbook accounts** tab of **Logbook settings** page see above item *User Accounts Creation*).



Press the **OK** button.

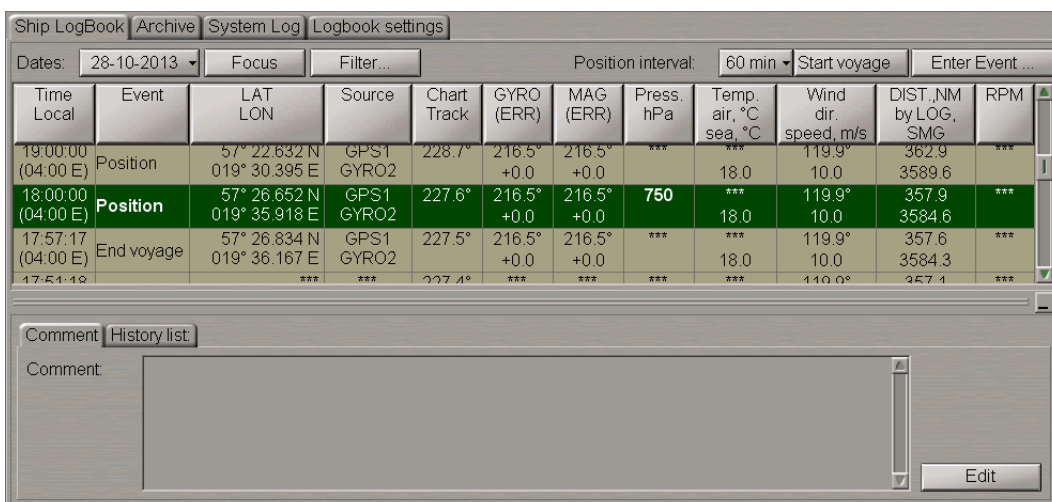

To view the corrections entered for the given event, switch to the **History list** tab.

The screenshot shows the 'Ship LogBook' interface with the 'History list' tab selected. The table below shows the logbook data:

Time Local	Event	LAT LON	Source	Chart Track	GYRO (ERR)	MAG (ERR)	Press. hPa	Temp. air, °C sea, °C	Wind dir. speed, m/s	DIST., NM by LOG, SMG	RPM
19:00:00 (04:00 E)	Position	57° 22.632 N 019° 30.395 E	GPS1 GYRO2	228.7°	216.5° +0.0	216.5° +0.0	***	18.0	119.9° 10.0	362.9 3589.6	***
18:00:00 (04:00 E)	Position	57° 26.652 N 019° 35.918 E	GPS1 GYRO2	227.6°	216.5° +0.0	216.5° +0.0	750	18.0	119.9° 10.0	357.9 3584.6	***
17:57:17 (04:00 E)	End voyage	57° 26.834 N 019° 36.167 E	GPS1 GYRO2	227.5°	216.5° +0.0	216.5° +0.0	***	18.0	119.9° 10.0	357.6 3584.3	***
17:54:18		***	***	227.4°	***	***	***	18.0	119.9°	357.1	***

Below the table, the 'History list' tab is active, showing a comment: 'Edited by: 3rd officer William Kidd [29/11/13 14:40:42] Press: - Changed from *** to 750'.

Separating Voyages

To differentiate the logbook events by voyages and to enable the subsequent display of events connected with a certain voyage, the capability to specify the voyage beginning and end is provided.

At the beginning of the voyage, press the **Start voyage** button.

The screenshot shows the 'Ship LogBook' interface with the 'Start voyage' button highlighted in the top right corner. The table below shows the logbook data:

Time Local	Event	LAT LON	Source	Chart Track	GYRO (ERR)	MAG (ERR)	Press. hPa	Temp. air, °C sea, °C	Wind dir. speed, m/s	DIST., NM by LOG, SMG	RPM
17:00:00 (04:00 E)	Position	57° 30.633 N 019° 41.397 E	GPS1 GYRO2	226.6°	216.5° +0.0	216.5° +0.0	***	18.0	119.9° 10.0	352.9 3579.6	***
16:55:47 (04:00 E)	Change of...	57° 30.781 N 019° 41.601 E	GPS1 GYRO2	226.6°	216.5° +0.0	216.5° +0.0	***	18.0	119.9° 10.0	352.7 3579.4	***
16:41:00 (04:00 E)	Chart	57° 31.905 N 019° 43.150 E	GPS1 GYRO2	226.4°	216.5° +0.0	216.5° +0.0	***	18.0	119.9° 10.0	351.3 3578.0	***
16:35:50	Out of VTD	57° 32.252 N	GPS1	226.3°	216.5°	216.5°	***	18.0	119.9°	350.9	***

Below the table, the 'History list' tab is active, showing a comment field and an 'Edit' button.

From the **User** drop-down list in the **User accounts** window which will appear, select the user account and enter the comment and password.

The screenshot shows the 'User accounts' dialog box with the following fields and buttons:

- Comment:** Voyage from S-Petersburg to Hamburg with 12000 tons of coal.
- User:** Captain Den Brown (selected from a drop-down list)
- Password:** **** (masked)
- Forgot?** button
- OK** and **Cancel** buttons

Press the **Ok** button.



Start Voyage dialog box with the following fields:

- Voyage No.: 12
- From: St-Petersburg
- To: Hamburg
- Buttons: OK, Cancel

Use the relevant boxes to enter the voyage number, port of departure and port of destination. Press the **Ok** button.

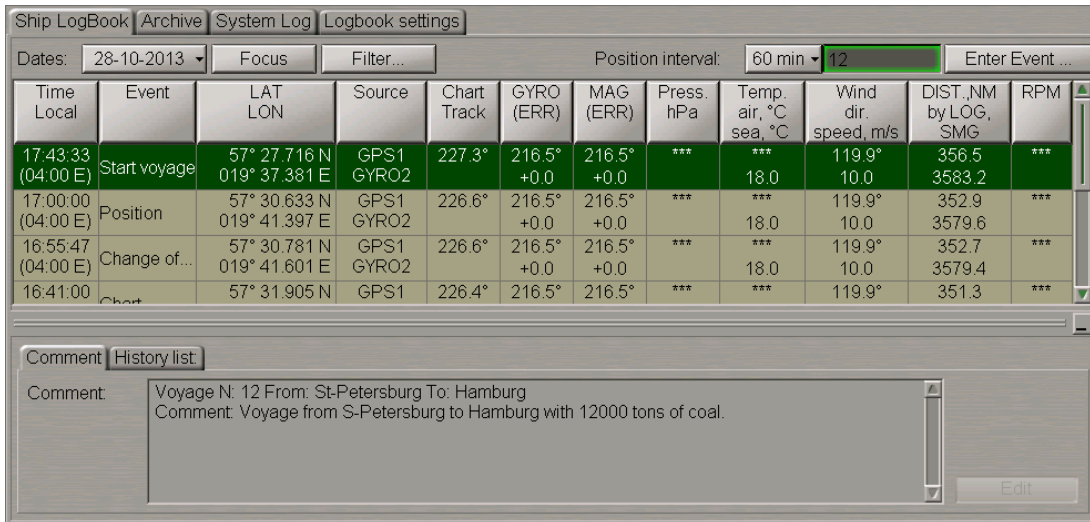

Ship Logbook interface showing the 'Start voyage' event. The event is highlighted in green. The voyage number '12' is visible in the top right corner of the logbook page.

Time Local	Event	LAT LON	Source	Chart Track	GYRO (ERR)	MAG (ERR)	Press. hPa	Temp. air, °C sea, °C	Wind dir. speed, m/s	DIST.,NM by LOG, SMG	RPM
17:43:33 (04:00 E)	Start voyage	57° 27.716 N 019° 37.381 E	GPS1 GYRO2	227.3°	216.5° +0.0	216.5° +0.0	***	*** 18.0	119.9° 10.0	356.5 3583.2	***
17:00:00 (04:00 E)	Position	57° 30.633 N 019° 41.397 E	GPS1 GYRO2	226.6°	216.5° +0.0	216.5° +0.0	***	18.0	119.9° 10.0	352.9 3579.6	***
16:55:47 (04:00 E)	Change of...	57° 30.781 N 019° 41.601 E	GPS1 GYRO2	226.6°	216.5° +0.0	216.5° +0.0	***	18.0	119.9° 10.0	352.7 3579.4	***
16:41:00	Chart	57° 31.905 N	GPS1	226.4°	216.5°	216.5°	***	18.0	119.9°	351.3	***

Comment: Voyage N: 12 From: St-Petersburg To: Hamburg
Comment: Voyage from S-Petersburg to Hamburg with 12000 tons of coal.

The event is shown in the Ship Logbook. The voyage number is shown on the button in the top right corner of the page. Comments on this event cannot be edited, the **Edit** button is disabled.

After the end of the voyage press the button with its number in the top right corner of the Ship Logbook page.

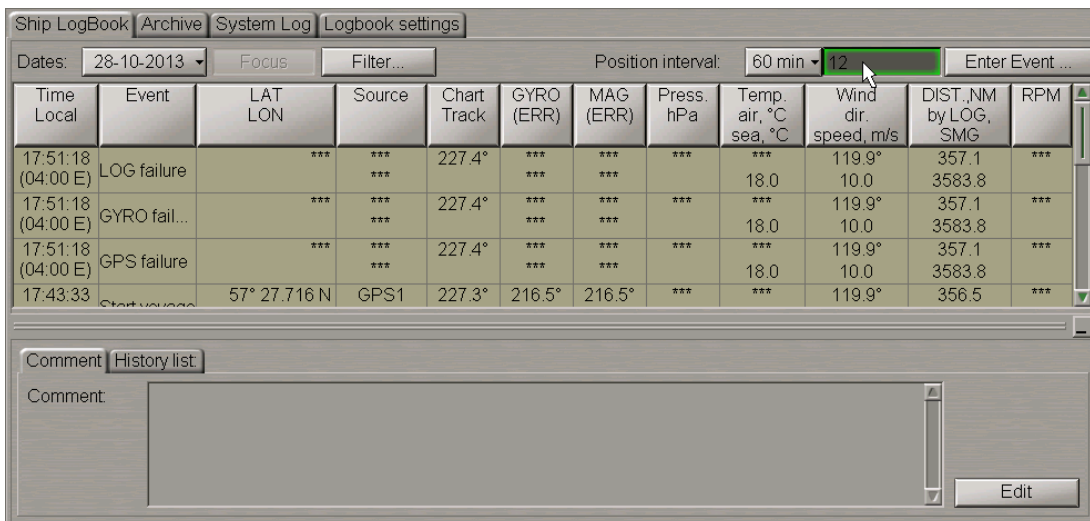

Ship Logbook interface showing the 'LOG failure' event. The event is highlighted in green. The voyage number '12' is visible in the top right corner of the logbook page.

Time Local	Event	LAT LON	Source	Chart Track	GYRO (ERR)	MAG (ERR)	Press. hPa	Temp. air, °C sea, °C	Wind dir. speed, m/s	DIST.,NM by LOG, SMG	RPM
17:51:18 (04:00 E)	LOG failure	***	***	227.4°	***	***	***	18.0	119.9° 10.0	3583.8	***
17:51:18 (04:00 E)	GYRO fail...	***	***	227.4°	***	***	***	18.0	119.9° 10.0	357.1 3583.8	***
17:51:18 (04:00 E)	GPS failure	***	***	227.4°	***	***	***	18.0	119.9° 10.0	357.1 3583.8	***
17:43:33	Start voyage	57° 27.716 N	GPS1	227.3°	216.5°	216.5°	***	18.0	119.9°	356.5	***

Comment:
Edit

From the **User** drop-down list in the **User accounts** window which will appear, select the user account and enter the comment and password.

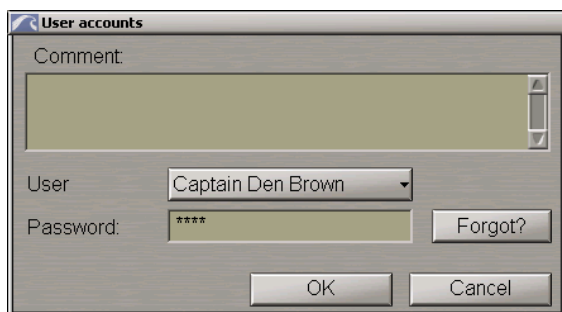

The 'User accounts' dialog box contains a 'Comment' text area, a 'User' dropdown menu with 'Captain Den Brown' selected, a 'Password' text area with four asterisks, and a 'Forgot?' button. At the bottom are 'OK' and 'Cancel' buttons.

Press the **Ok** button.

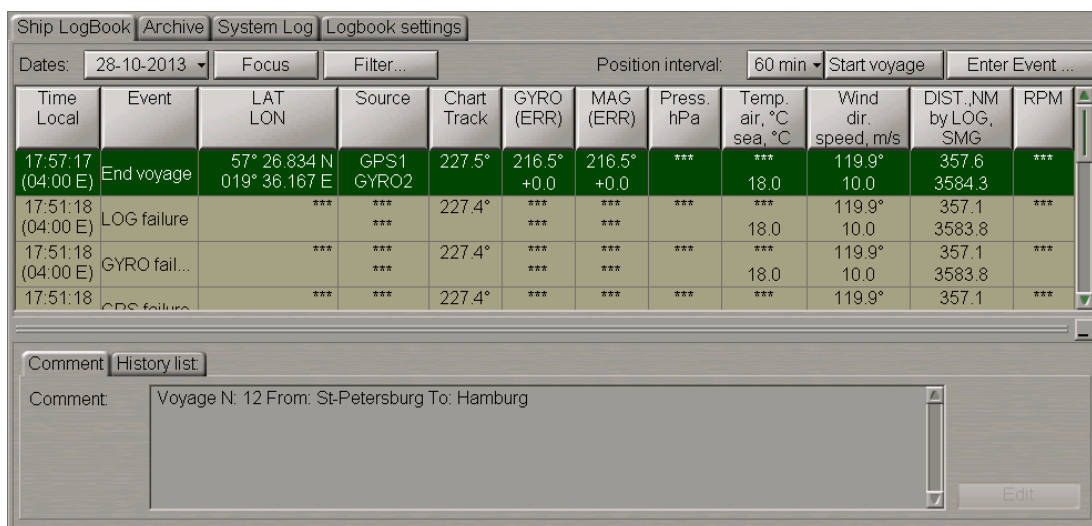

The 'Ship LogBook' interface shows a table of log entries. The first entry is highlighted in green and is an 'End voyage' event. Below the table is a 'Comment' field with the text 'Voyage N: 12 From: St-Petersburg To: Hamburg' and a disabled 'Edit' button.

Time Local	Event	LAT LON	Source	Chart Track	GYRO (ERR)	MAG (ERR)	Press. hPa	Temp. air, °C sea, °C	Wind dir. speed, m/s	DIST.,NM by LOG, SMG	RPM
17:57:17 (04:00 E)	End voyage	57° 26.834 N 019° 36.167 E	GPS1 GYRO2	227.5°	216.5° +0.0	216.5° +0.0	***	*** 18.0	119.9° 10.0	357.6 3584.3	***
17:51:18 (04:00 E)	LOG failure	***	***	227.4°	***	***	***	18.0	119.9° 10.0	357.1 3583.8	***
17:51:18 (04:00 E)	GYRO fail...	***	***	227.4°	***	***	***	18.0	119.9° 10.0	357.1 3583.8	***
17:51:18	GPS failure	***	***	227.4°	***	***	***	18.0	119.9°	357.1	***

The event is shown in the Ship Logbook. Comments on this event cannot be edited, the **Edit** button is disabled. The **End of voyage** event is just a mark to identify the voyage period (for database query, for printing purposes).

Work with Archive

Open **Logbook** panel by selecting the appropriate line of **Tasks List** menu in the tabs zone of the ECDIS task screen.

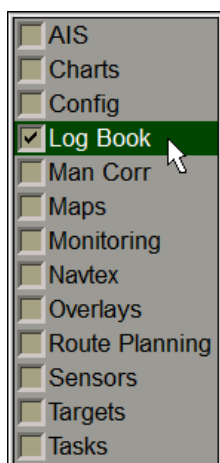

Use the tab in the top part of **Logbook** panel, which will open up, to switch to **Archive** page.



The **Archive** page is designed for displaying archived Ship Logbooks. For the archiving rules see *Multi-Functional Display (v. 3.00.340). Functional Description, Chapter 6* document, section *Ship Logbook*, paragraph *Archiving Ship Logbook*.

Press the **Ship LogBook** button and select the necessary archive from the list box.

Note: In the Ship LogBook events are stored for 90 days. Then they are moved automatically to the archive. In the archive they are stored as long as there is space on the disk.



The page will display records contained in the archive.

Press the **Jump to date** button and select the date which the Ship Logbook records will be displayed for.



The table will display Ship Logbook events starting from the first event of the selected date. It should be noted that on the **Archive** page you can only view the Ship Logbook.

To filter events on the **Archive** page you can also use a filter described in the *Events Filtering* paragraph of the *Using Ship Logbook* section.

Ship Logbook Printout

Open **Logbook** panel by selecting the appropriate line of **Tasks List** menu in the tabs zone of the ECDIS task screen.

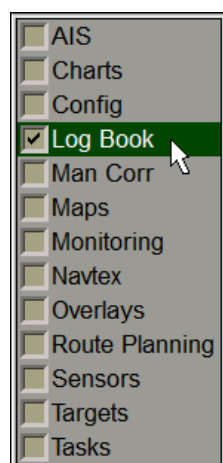

Use the tab in the top part of **Logbook** panel, which will open up, to switch to **Log Settings** page. On the **Logbook settings** page switch to **Print Settings** tab.

In **Header** group enter the following information in the input lines:

- **Gross tons** – gross tonnage of the vessel;
- **Net tons** – net tonnage of the vessel;
- **DWT tons** – vessel's deadweight capacity.

The Captain's name in the **Master** input line is entered automatically with a change of command (see section *Using Ship Logbook*, paragraph *Event Entering and Editing*). The name of the master who assumed the command will be shown in the logbook printout.

If for some reasons the name of the person who assumed the command is not entered (or the active master's name is deleted) the **Header** group will look like follows:

Press the **Change of command** button and determine the name of the person who assumed command as described in the *Event Entering and Editing* paragraph of the *Using Ship Logbook* section.

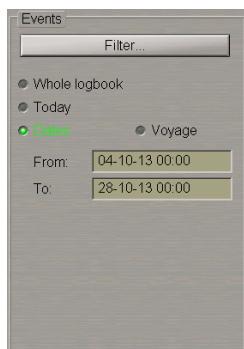

In the **Events** group select the printout range: **Whole logbook**, **Today** or **Dates**. In the case of **Dates**, use **From** and **To** input boxes to set the time interval for the printout of the Ship Logbook.

If several voyages fall within the selected time interval, during the printout they will be shown with their respective numbers. The new voyage information is started on a new page of the report.

Note: By using the **Data** filter you can also print out an archive Ship Logbook.

If it is necessary to print out the Ship Logbook for a certain voyage, check the **Voyage** checkbox.

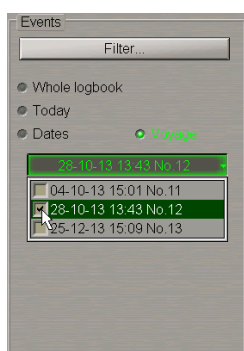

From the drop-down list select the necessary voyage(s) and check the checkbox(es) next to its/their name(s). While printing out the Ship Logbook, it is also possible to filter events by their names. To do this, press the **Filter** button.

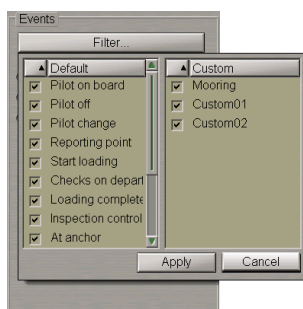

Turned on by default, is the display of all the default and custom events available in the **Enter Event** control (see section *Using Ship Logbook*, paragraph *Event Entering and Editing*).

To turn off the print of some events, uncheck the appropriate checkboxes next to the names of these events. You can also use a context menu for selecting/deselecting all the events, and sorting as described for the Ship logbook filter in the *Events Filtering* paragraph of *Using Ship Logbook* section.

Press the **Apply** button.

If display of some of the events was disabled, the "*" symbol appears on the button.



In the **Orientation** group select the text orientation on the page during the printout: **Portrait** or **Landscape**.

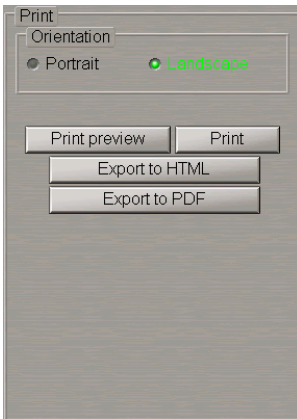

Select the printout range: **Whole logbook**, **Today** or **Dates**. In the case of **Dates**, use **From** and **To** input boxes to set the time interval for the printout of the Ship Logbook.

Note: By using the **Data** filter you can also print out an archive Ship Logbook.

For the Ship Logbook print preview, press the **Print preview** button.

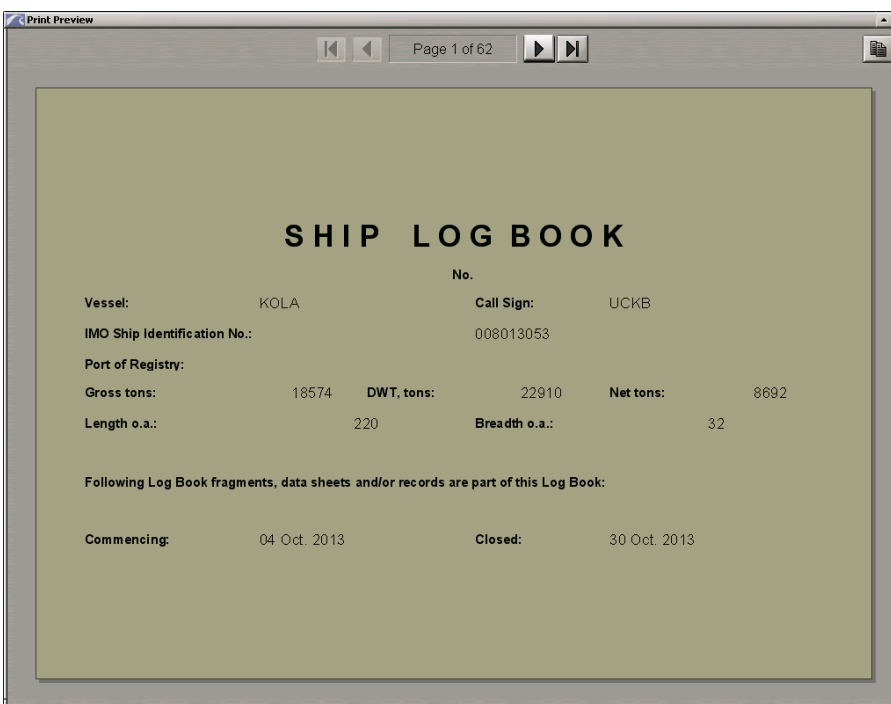

Data entered in the **Header** group is displayed on the title sheet on the Ship Logbook. On the subsequent pages, headers display the Ship name, IMO No, Voyage Data.

If voyages are selected for printing out, the Ship Logbook looks as follows:

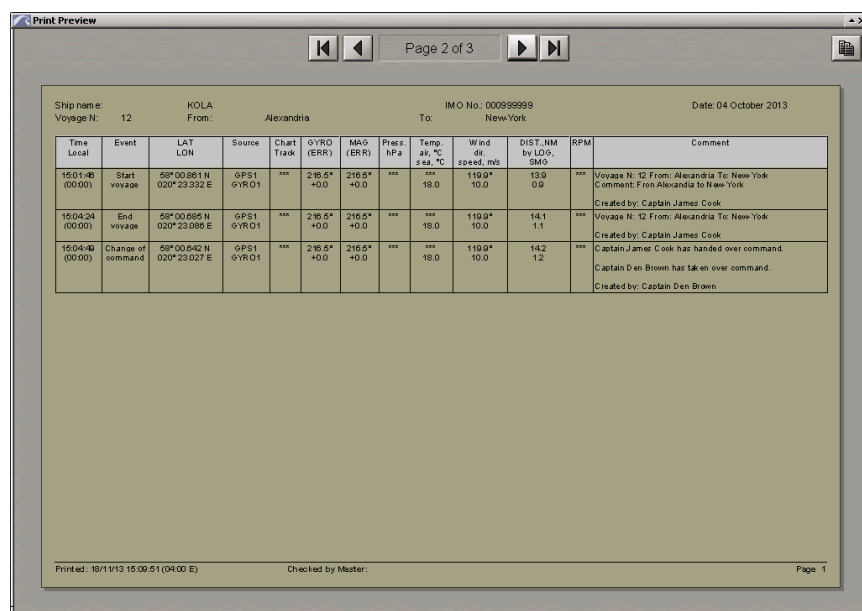

Time Local	Event	LAT LON	Source	Chart Track	GYRO (ERR)	MAG (ERR)	Pres: hPa	Temp. air, °C sea, °C	Wind dir speed, m/s	DIST_NM by LGS, SMO	RPM	Comment
150148 (00.00)	Start voyage	59°00'08.1 N 020°23'33.2 E	GPS1 GYR01	***	216.5* +0.0	216.5* +0.0	***	18.0	110.9* 10.0	13.0 0.9	***	Voyage N: 12 From: Alexandria To: New York Comment: From Alexandria to New York Created by: Captain James Cook
150424 (00.00)	End voyage	59°00'08.6 N 020°23'08.0 E	GPS1 GYR01	***	216.5* +0.0	216.5* +0.0	***	18.0	110.9* 10.0	14.1 1.1	***	Voyage N: 12 From: Alexandria To: New York Created by: Captain James Cook
150440 (00.00)	Change of command	59°00'04.2 N 020°23'02.7 E	GPS1 GYR01	***	216.5* +0.0	216.5* +0.0	***	18.0	110.9* 10.0	14.2 1.2	***	Captain James Cook has handed over command. Captain Den Brown has taken over command. Created by: Captain Den Brown

Printed: 18/11/13 15:00:51 (04:00 E) Checked by Master: Page 1

In this case all the events are sorted by voyages, and events of every new voyage start to be displayed on a new page.

Close the **Print Preview** window and press the **Print** button.

To convert the Ship Logbook to the * .pdf file, press the **Export to PDF** button.

To convert the Ship Logbook to the * .html file, press the **Export to HTML** button.

Files has names in the Logbook (DD-Month-YYYY - DD-Month-YYYY) . * format, dates in the name show the time interval whose data was included in the file.

Files can be copied by using the Data Tool utility (Track feature, Ship's Logbook (PDF) and Ship's Logbook (HTML) file groups) for subsequent use.

Using Electronic System Logbook



Attention! The Electronic System log is not synchronised in the net among WS's.

Open **Logbook** panel by selecting the appropriate line of **Tasks List** menu in the tabs zone of the ECDIS task screen.

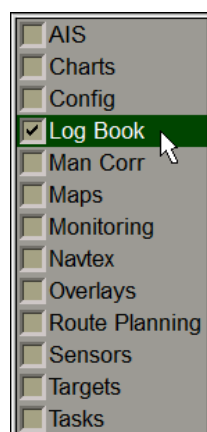



Use the tab in the top part of **Logbook** panel, which will open up, to switch to **System Log** page.

Settings	Date	14-10-12	14-10-12	
14-10-2012	Time	00:00:00(UTC)	00:00:00(UTC)	01:00
Fields	Event	ON HOUR	WATCH	
Filter	Primary Sensor	GPS 1	GPS 1	
Reset Dist.	Secondary Sensor	None	None	
Print	L/L	58°56'630 N, 019°06'645 E	58°56'630 N, 019°06'645 E	58°56'630 N, 019
	Offset L/L	00°00'000 N, 000°00'000 E	00°00'000 N, 000°00'000 E	00°00'000 N, 000
	Prim/Sec Diverge			
	COG - SOG	270.0°-9.0 kn	270.0°-9.0 kn	270
	HDG - LOG	270.0°-9.0 kn	270.0°-9.0 kn	270
	Average speed	0.0 kn	0.0 kn	
	WatchDist-Log	0.0 nm-36.0 nm	0.0 nm-36.0 nm	0.0

System Log page is designed for the recording of events, which occurred during the ECDIS task operation. The table is a set of columns (events) and of rows (event parameters). By default, the table reflects the following event parameters:

- **Date** – date of the event;
- **Time** – time of the event (UTC);
- **Event** – name of the event;
- **Primary Sensor** – primary positioning system;
- **Secondary Sensor** – secondary positioning system;
- **L/L** – event latitude/longitude coordinate;
- **Offset L/L** – event latitude/longitude offset;
- **Prim/Sec Diverge** – distance and direction to the secondary positioning system (large – distance exceeding the limit set in the safety parameters);
- **COG - SOG** – course and speed values received from the positioning system;
- **HDG - LOG** – course and speed values received from the compass and log;
- **Average speed** – average speed in the last 10 minutes;
- **WatchDist-Log** – distance covered during the watch (by chart – by log);
- **DAY DIST-LOG** – distance covered in 24 hours (by chart – by log);
- **VOY DIST-LOG** – summary distance passed (by chart – by log);
- **Echo Sounder** – depth from the sounder or entered manually if the sounder is not connected in the System Configuration utility;
- **Charts displayed** – charts loaded for proceeding in Navigation Mode, the source specified (ARCS, BSB – BSB/NDI, ENC, TRS – TX-97, SRF – Seafarer);
- **Wind direction** – true wind direction;
- **Wind speed** – true wind speed;
- **Water temperature** – water temperature.

- **Voice comment** – voice comment. The table cell has a control panel containing the following buttons:
 -  to rewind to the start;
 -  to play back a voice comment;
 -  to stop the playback.

The following system log fields are filled in by the operator manually:

- **Remarks** – operator notes;
- **Wave direction** – wave direction value entered by the operator;
- **Wave Height** – wave height value entered by the operator;
- **Air temperature** – air temperature value entered by the operator;
- **Pressure** – atmospheric pressure value entered by the operator;
- **Visibility** – visibility range value entered by the operator;
- **Engine RPM** – main engine rpm value entered by the operator.

To do this, position the free cursor on the necessary cell and press the left trackball button. Type the necessary message and press the left trackball button or the <Enter> key:

Remarks	The drifting container is found
Wave direction	120.0°
Wave Height	2.0 m

In Settings group select the necessary date (current date is set by default):

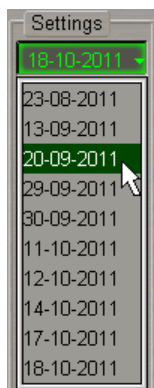

To change contents of the electronic system logbook (delete unnecessary event parameters), press **Fields** button:

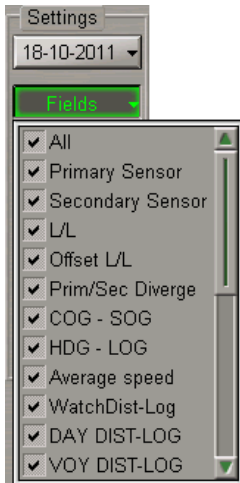

Uncheck checkboxes of the unnecessary event parameters.

By default, it is only **Main** group of events which is displayed in the system log (see document *Multi-Functional Display (v. 3.00.340). Functional Description, Chapter 6*, section *Electronic System Logbook*, paragraph *Electronic System Logbook Formations Principles*). To display other groups of events in the system log, press **Filter** button in **Settings** group.

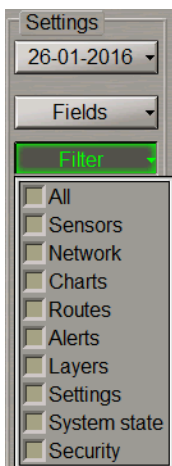

Check checkboxes of the necessary parameter groups.

To set the value of the total covered distance to zero, press **Reset Dist.** button in **Settings** group.

To print out the electronic system logbook, press **Print** button in **Settings** group.

Note: The printer is required to be connected to the one of WS's. For the printer to be used as a network printer, the printer settings should be made.



Use **From** and **To** input boxes to set the time interval for the printout of the electronic system logbook events, and press **Print** button.

Own Ship Track in the ECDIS Task

Setting Track Display Elements

Open **Monitoring** panel by selecting the appropriate line of **Tasks List** menu in the tabs zone of the ECDIS task screen.



Use the tab in the top part of **Monitoring** panel, which will open up, to switch to **Route Monitoring** page.

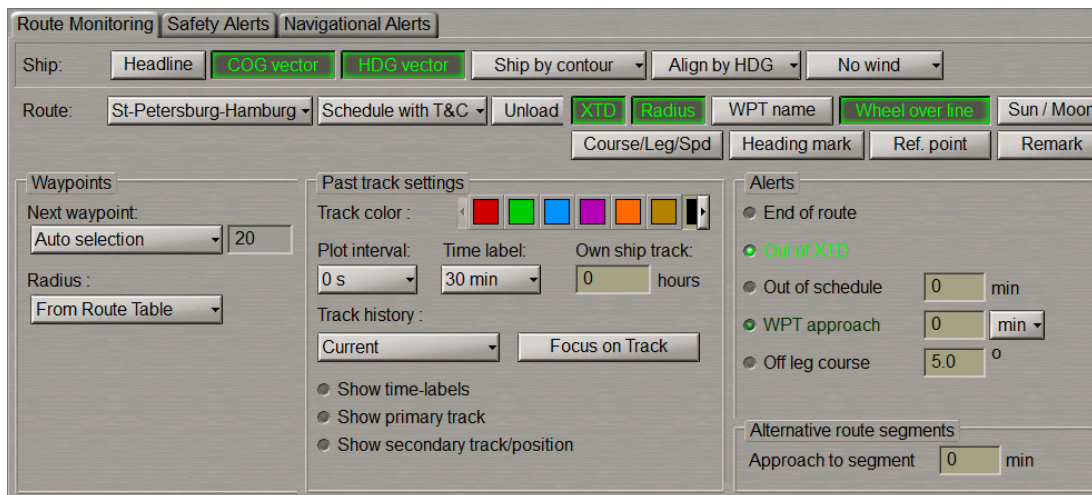

In **Past track settings** group of **Route Monitoring** page, which will open up, set the colour of the track segment, which is being formed, by selecting it from the offered **Track colour** palette.



Press **Plot interval** button.

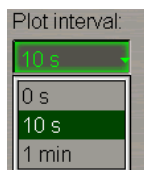

In the list, which will open up, select the track plot interval and press the left trackball button.

Use **Own ship track** input line to enter the time value which the length of the displayed own ship track will correspond to.

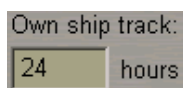

Show primary track checkbox is checked by default.

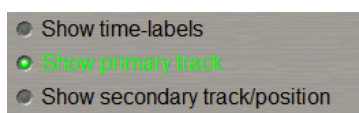

If its necessary to turn off the display of a track from the primary positioning system, uncheck this checkbox. If it is necessary to turn on the display of a track and ship symbol from the secondary positioning system on the Chart panel, check the **Show secondary track/position** checkbox.

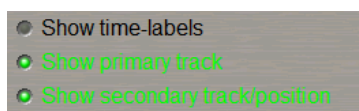

If it is necessary to turn on the display of a time labels on the primary and secondary tracks check the **Showtime-labels** checkbox.



Press **Plot interval** button.

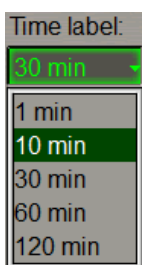

In the list, which will open up, select the track plot interval and press the left trackball button.

Open **Logbook** panel by selecting the appropriate line of **Tasks List** menu in the tabs zone of the ECDIS task screen.

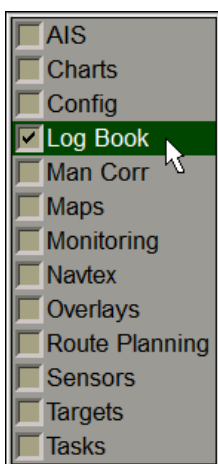

Use the tab in the top part of **Logbook** panel, which will open up, to switch to **System Log** page. In the left-hand part of **System Log** page, press **Filter** button.

Ship LogBook		Archive	System Log	Logbook settings
Settings	Date	14-10-12	14-10-12	
14-10-2012	Time	00:00:00(UTC)	00:00:00(UTC)	01:00
Fields	Event	ON HOUR	WATCH	
Filter	Primary Sensor	GPS 1	GPS 1	
Reset Dist.	Secondary Sensor	None	None	
Print	L/L	58°56'630 N, 019°06'645 E	58°56'630 N, 019°06'645 E	58°56'630 N, 019°06'645 E
	Offset L/L	00°00'000 N, 000°00'000 E	00°00'000 N, 000°00'000 E	00°00'000 N, 000°00'000 E
	Prim/Sec Diverge			
	COG - SOG	270.0°-9.0 kn	270.0°-9.0 kn	270.0°-9.0 kn
	HDG - LOG	270.0°-9.0 kn	270.0°-9.0 kn	270.0°-9.0 kn
	Average speed	0.0 kn	0.0 kn	0.0 kn
	WatchDist.L on	0.0 nm-36.0 nm	0.0 nm-36.0 nm	0.0 nm-36.0 nm

Check the checkboxes of the event groups, which are required to be displayed on the track.

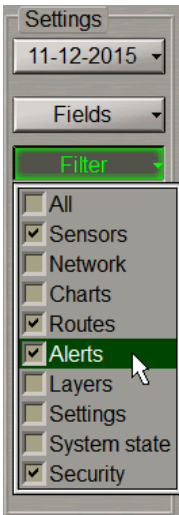

These events will be shown in the form of time tags on the set own ship track

Viewing Archive Tracks

Open **Monitoring** panel by selecting the appropriate line of **Tasks List** menu in the tabs zone of the ECDIS task screen.

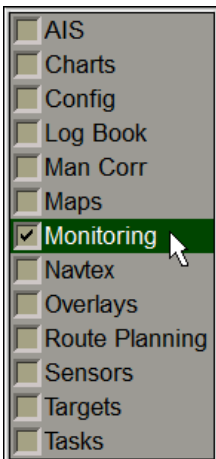

Use the tab in the top part of **Monitoring** panel, which will open up, to switch to **Route Monitoring** page.

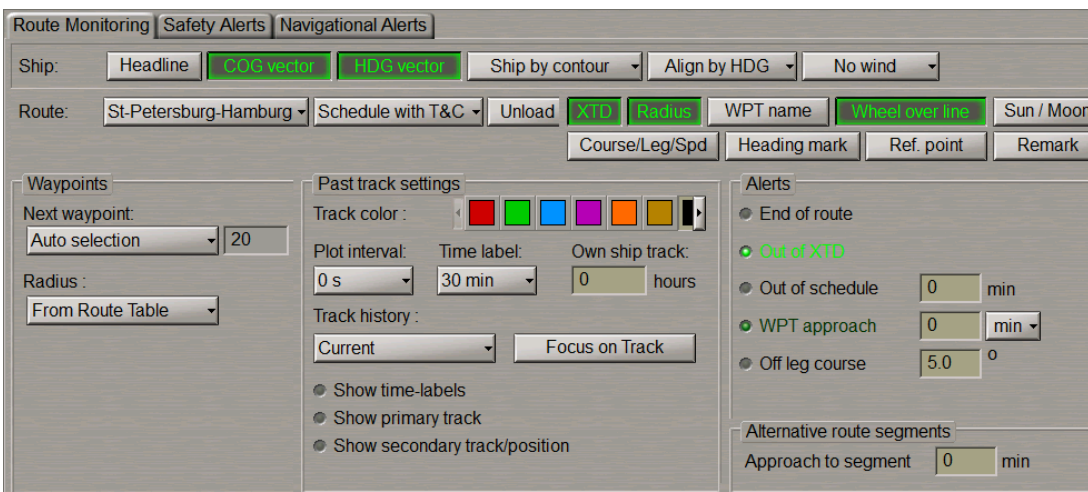

In **Past track settings** group of **Route Monitoring** page, which will open up, press **Plot interval** button:

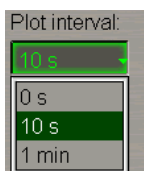

In the list, which will open up, select the track plot interval and press the left trackball button.

Press **Track history** button:

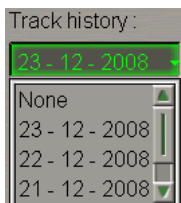

In the list, which will open up, select the date of the track required to be displayed, and press the left trackball button. The selected date track is displayed on the Chart panel.

To display the entire own ship track for the selected date on the Chart panel, press **Focus on Track** button.

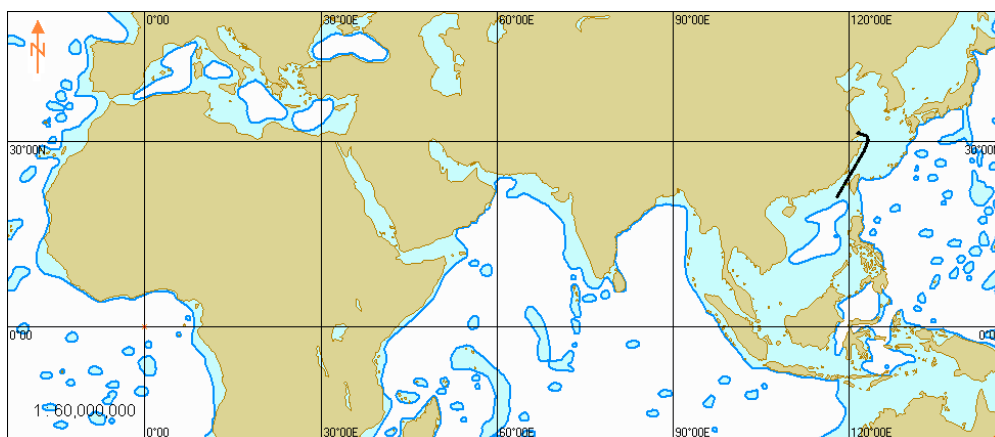

Chapter 7.

Manual Updating

This chapter describes the procedure used in the handling of updating objects.

<u>Turning On/Off the Display of Updating Objects and Their Attributes</u>	210
<u>Creating and Plotting Updating Objects</u>	211
Plotting Point Type Objects	212
Plotting Circles and Circumferences	214
Plotting Lines and Areas	216
Plotting Text Object	218
Plotting Depth Object	220
Assigning “Attached File” Attribute	222
<u>Editing Updating Objects</u>	224
Editing Updating Objects Attributes	224
Editing Object Coordinates	226
Deleting Updating Object	228
Restore the Deleted Object	229
<u>Search for Updating Objects</u>	231

Turning On/Off the Display of Updating Objects and Their Attributes



Attention! Point type objects cannot be displayed on scales smaller than 1:600,000.

Open **Manual Correction** panel by selecting the appropriate line of **Tasks List** in the tabs zone of the ECDIS task screen.

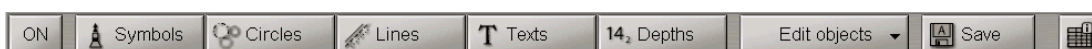

To turn on/off the display of updating objects on the ECDIS task screen press **ON** button.

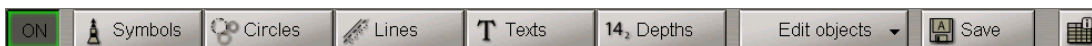

To open the **Manual Correction** panel completely press  button.

Type	Danger	Modified	State	Start time (UTC)	End time (UTC)	Latitude	Longitude
Symbol	No	10-12-09 15:22	Normal				
Symbol	No	10-12-09 15:22	Normal				
Symbol	No	10-12-09 15:22	Normal				
Line	No	04-02-10 08:16	Normal				

Display options

Attachments Deleted Colored Timed objects

To turn on/off the display of updating objects attributes on the ECDIS task screen, on **Display options** page press the following buttons:

- **Attachments** – to turn on highlighting of objects with attached files;
- **Deleted** – to turn on highlighting of deleted objects;
- **Colored** – to turn on orange coloured highlighting of updating objects;
- **Timed objects** – to turn on the display of temporary updating objects until the time when they become effective.



Creating and Plotting Updating Objects



Attention! Point type objects cannot be displayed on scales smaller than 1:600,000.

Open **Manual Correction** panel by selecting the appropriate line of **Tasks List** in the tabs zone of the ECDIS task screen.

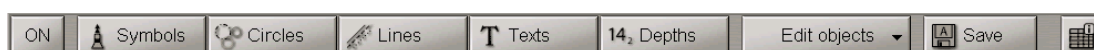
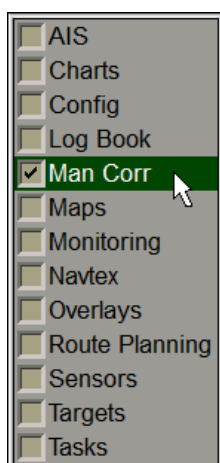

To turn on/off the display of updating objects on the ECDIS task screen press **ON** button.

The updating object creating and plotting procedure consists of four stages:

- selection of the object category and type;
- assigning of attributes to the object (except attached files);
- plotting of an object;
- assigning of “attached file” attribute.

Plotting Point Type Objects

Press **Symbols**  **Symbols** button.

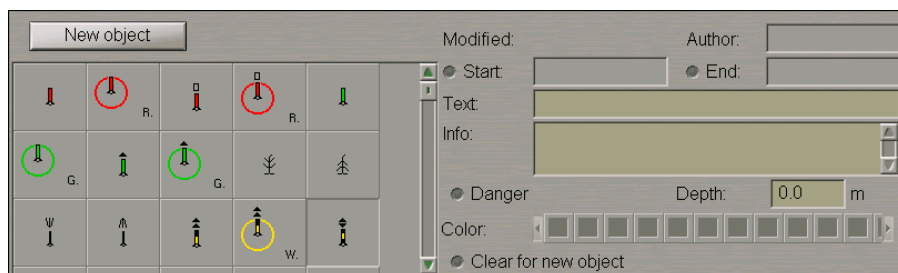

Press the button with point type object in the table:

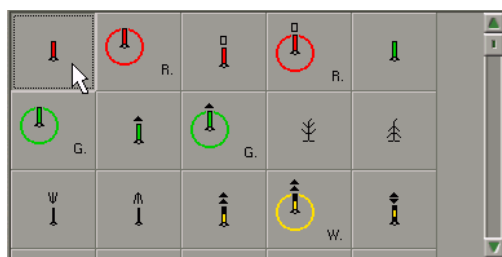

Select the type of updating object symbol from the table and press the left trackball button.

Set the updating display time (“Temporary updating” attribute). To do this, check **Start** checkbox. By trackball set the start date and time of the updating object display and press the right trackball button.

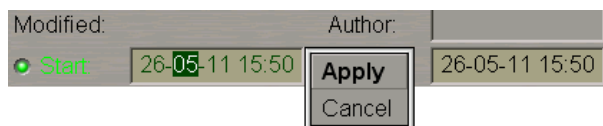

Press **Apply** button to confirm the changes you have made.

Check **End** checkbox and set the updating object display end date and time.

Enter the required text (“Text” attribute) in **Text** input line (information will be displayed on the chart).

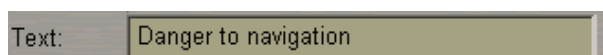

Enter the required information (“Object information” attribute) in **Info** field (information will not be displayed unless Info function is used).

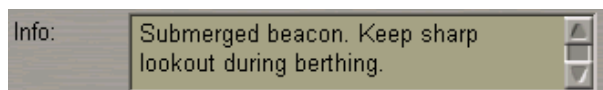

Check **Danger** checkbox (“Danger to navigation” attribute) as required.

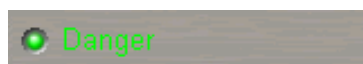

Set the required depth value (“Object depth” attribute) in **Depth** line.

Depth: m

Files are attached (“Attached file” attribute) after the plotting of the updating object.

To plot the updating object on the chart, press **New object** button.

Graphic cursor  will appear on the Chart Panel, whereas the right bottom part of the screen will display **Add Symbol** information window with cursor coordinates.

Add Symbol	
Latitude	<input type="text" value="60°22.840' N"/>
Longitude	<input type="text" value="027°35.423' E"/>
Ship position	
	<input type="radio"/> true <input type="radio"/> relative
Bearing	<input type="text" value="290.8"/> <input type="text" value="000.0"/> °
Opp. Bearing	<input type="text" value="110.8"/> <input type="text" value="180.0"/> °
Range	<input type="text" value="2.86"/> NM
	<input type="text" value="5291"/> m
Press Tab to edit manually	

Position the cursor in the required coordinates.

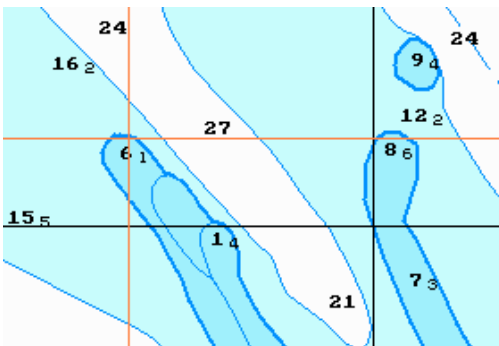

Press the left trackball button: the point type object will be set in the specified coordinates.

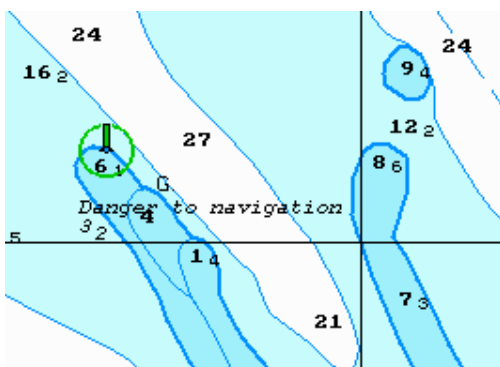

Press the right trackball button to exit from the editing mode. The cursor will assume the shape of the ECDIS task free cursor.

Information on the plotted updating object will be displayed in the table on **Manual Correction** panel.

Type	Danger	Modified	State	Start time (UTC)	End time (UTC)	Latitude	Longitude
Symbol	No	26-05-11 16:26	Normal	26-05-11 15:50	26-06-11 15:50	60° 22.261 N	027° 35.066 E

Display options

Attachments Deleted Colored Timed objects

Press Save button.

Plotting Circles and Circumferences

Press Circles  button.

Select the type of circle updating object from the table.

New object

Modified: Author:

Start: End:

Text:

Info:

Danger: Depth: 0.0 m

Color: 

Clear for new object

Set the updating object colour (“Object colour” attribute). Select it from the **Color** palette.

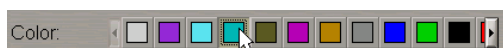

Set the updating object display time (“Temporary updating” attribute), text (“Text” attribute), required information (“Object information” attribute), “Danger to navigation” attribute and required depth value (“Object depth” attribute) (see paragraph *Plotting Point Type Object*).

Files are attached (“Attached file” attribute) after the plotting of the updating object.

To plot the updating object on the chart, press **New object** button.

Graphic cursor  will appear on the Chart Panel, whereas the right bottom part of the screen will display **Add Circle** information window with cursor coordinates.

Add Circle	
Latitude	60°21.685' N
Longitude	027°35.237' E
Ship position	
	true relative
Bearing	111.0 ◀ 179.8 °
Opp. Bearing	291.0 ▶ 000.2 °
Range	303.66 NM
Press Tab to edit manually	

Position the cursor in the central point and press the left trackball button.

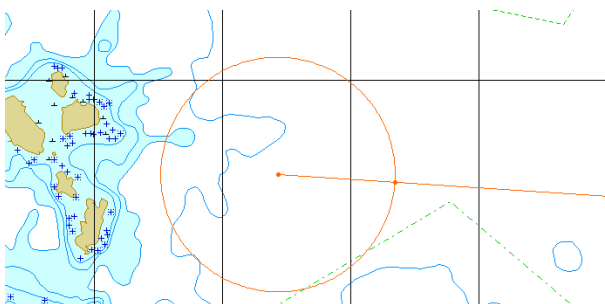

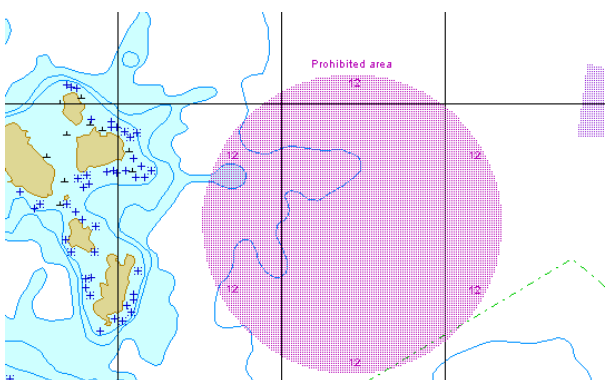

After that move the cursor to the necessary radius and press the left trackball button again.



Press the right trackball button to exit from the editing mode. The cursor will assume the shape of the ECDIS task free cursor.

Information on the plotted updating object will be displayed in the table on **Manual Correction** panel.

Type	Danger	Modified	State	Start time (UTC)	End time (UTC)	Latitude	Longitude
 Symbol	No	26-05-11 16:26	Normal	26-05-11 15:50	26-06-11 15:50	60° 24.637 N	027° 31.430 E
 Circles	Yes	27-05-11 12:20	Normal	26-05-11 15:50	26-06-11 15:50		

Display options: Attachments Deleted Colored Timed objects

Press **Save** button.

Plotting Lines and Areas

Press **Lines**  button.

New object
Modified:
Author:

Start:

End:

Text:
 Info:

Danger
 Depth: m

Color:

Clear for new object

Set the updating object colour (“Object colour” attribute). Select it from the **Color** palette.

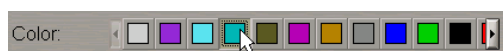

Set the updating object display time (“Temporary updating” attribute), text (“Text” attribute), required information (“Object information” attribute), “Danger to navigation” attribute and required depth value (“Object depth” attribute) (see paragraph *Plotting Point Type Object*).

Files are attached (“Attached file” attribute) after the plotting of the updating object.

To plot the updating object on the chart, press **New object** button.

Graphic cursor  will appear on the Chart Panel, whereas the right bottom part of the screen will display **Add Line** information window with cursor coordinates.

Add Line	
Latitude	60°22.259' N
Longitude	027°35.045' E
Ship position	
	<input type="radio"/> true <input type="radio"/> relative
Bearing	110.9 ◀ 179.9 °
Opp. Bearing	290.9 ▶ 000.1 °
Range	304.38 NM
Press Tab to edit manually	

Position the cursor in the initial point and press the left trackball button.

To set lines and areas, after the plotting of the initial point, move the cursor to the next point and press the left button again. Repeat the procedure until you set the required number of point.

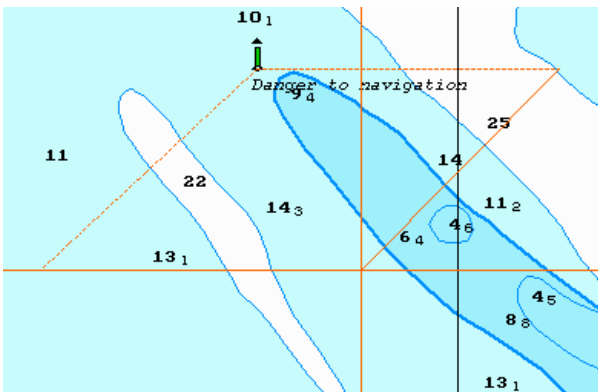

After the input of the last point of the line or area, press the right trackball button: the cursor will change its form, and the object will be set in the specified coordinates:

- line by the specified points;

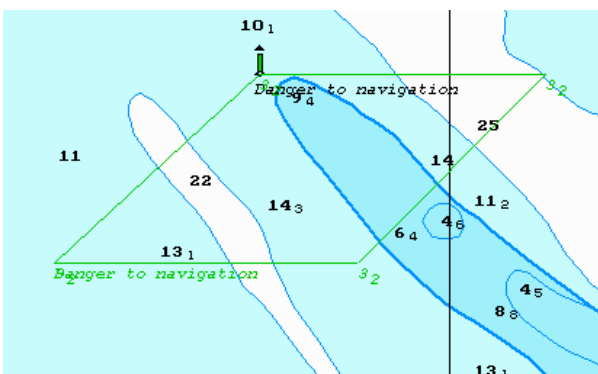

- area by the points, the first and the last of them connected.

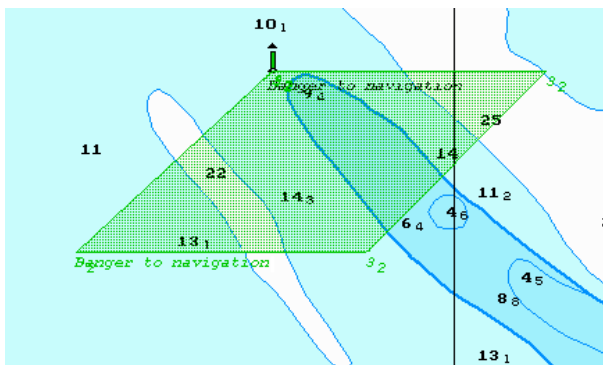

Information on the plotted updating object will be displayed in the table on **Manual Correction** panel.

Type	Danger	Modified	State	Start time (UTC)	End time (UTC)	Latitude	Longitude
Symbol	No	26-05-11 16:26	Normal	26-05-11 15:50	26-06-11 15:50	60° 22.260 N	027° 35.066 E
Circles	Yes	27-05-11 12:20	Normal	26-05-11 15:50	26-06-11 15:50	60° 21.864 N	027° 36.134 E
Line	No	27-05-11 12:40	Normal			60° 21.864 N	027° 34.330 E

Press Save button.

Plotting Text Object

Press Texts **T Texts** button.

New object

Modified: Author:

Start: End:

Text:

Info:

Danger Depth: m

Color:

Clear for new object

In the Text input window enter the necessary text.

Set the updating object colour (“Object colour” attribute). Select it from the Color palette.

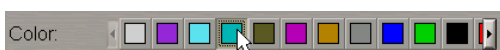



Set the updating object display time (“Temporary updating” attribute), required information (“Object information” attribute), “Danger to navigation” attribute and required depth value (“Object depth” attribute) (see paragraph *Plotting Point Type Object*).

Files are attached (“Attached file” attribute) after the plotting of the updating object.

To plot the updating object on the chart, press **New object** button.

Graphic cursor  will appear on the Chart Panel, whereas the right bottom part of the screen will display **Add Text** information window with cursor coordinates.

Add Text	
Latitude	60°22.742' N
Longitude	027°32.124' E
Ship position	
	<input type="radio"/> true <input type="radio"/> relative
Bearing	110.9  179.9 °
Opp. Bearing	290.9  000.1 °
Range	304.52 NM
Press Tab to edit manually	

Position the cursor in the required coordinates.

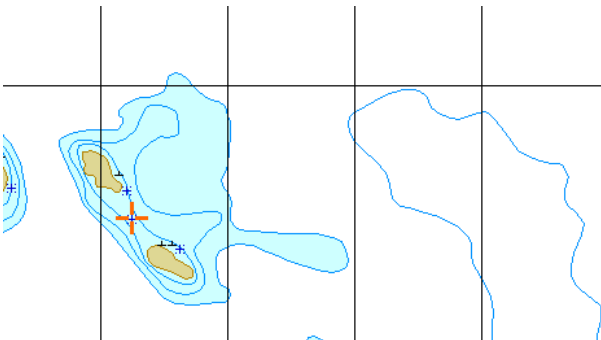

Press the left trackball button: the text type updating object will be set in the specified coordinates.

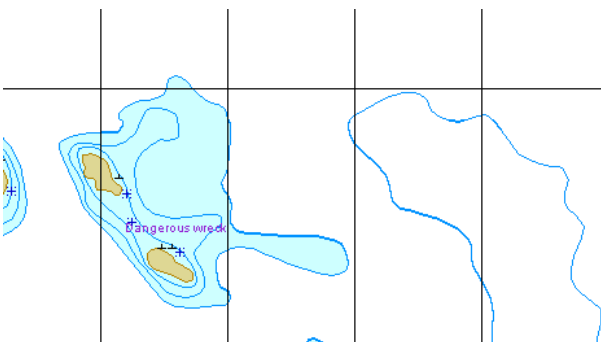

Press the right trackball button to exit from the editing mode. The cursor will assume the shape of the ECDIS task free cursor.

Information on the plotted updating object will be displayed in the table on **Manual Correction** panel.

Type	Danger	Modified	State	Start time (UTC)	End time (UTC)	Latitude	Longitude
 Symbol	No	26-05-11 16:26	Normal	26-05-11 15:50	26-06-11 15:50	60° 22.742 N	027° 32.101 E
Circles	Yes	27-05-11 12:15	Deleted	26-05-11 15:50	26-05-11 15:50		
Line	No	27-05-11 12:40	Normal				
Text	Yes	27-05-11 13:03	Normal				

Display options

Attachments Deleted **Colored** Timed objects

Press **Save** button.

Plotting Depth Object

Press **Depths** **14₂ Depths** button.

New object

Modified: _____ Author: _____

Start: _____ End: _____

Text: _____

Info: _____

Danger Depth: 0.0 m

Color: 

Clear for new object

In the **Depth** input window, enter the necessary depth.

Set the updating object colour (“Object colour” attribute). Select it from the **Color** palette.

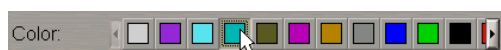

Set the updating object display time (“Temporary updating” attribute), text (“Text” attribute), required information (“Object information” attribute), “Danger to navigation” attribute and required depth value (“Object depth” attribute) (see paragraph *Plotting Point Type Object*).

Files are attached (“Attached file” attribute) after the plotting of the updating object.

To plot the updating object on the chart, press **New object** button.

Graphic cursor  will appear on the Chart Panel, whereas the right bottom part of the screen will display **Add Depth** information window with cursor coordinates.

Add Depth	
Latitude	60°22.422' N
Longitude	027°32.889' E
Ship position	
	true relative
Bearing	111.0 ◀ 179.8 °
Opp. Bearing	291.0 ▶ 000.2 °
Range	308.03 NM
Press Tab to edit manually	

Position the cursor in the required coordinates.

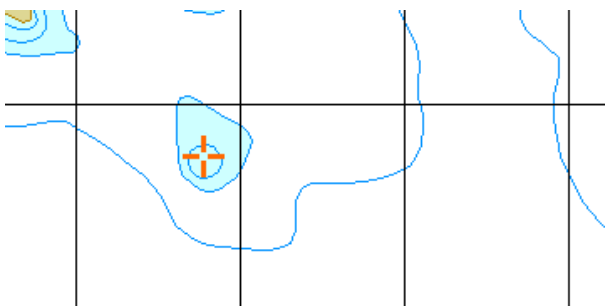

Press the left trackball button: the depth type updating object will be set in the specified coordinates.

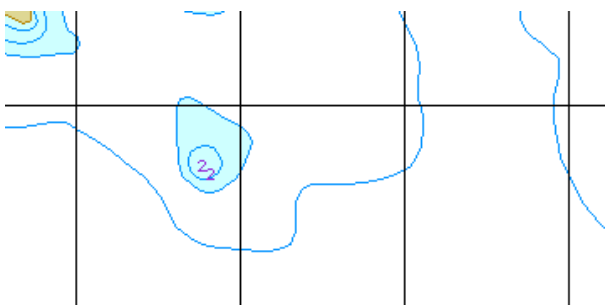

Press the right trackball button to exit from the editing mode. The cursor will assume the shape of the ECDIS task free cursor.

Information on the plotted updating object will be displayed in the table on **Manual Correction** panel.

Type	Danger	Modified	State	Start time (UTC)	End time (UTC)	Latitude	Longitude
Symbol	No	26-05-11 16:26	Normal	26-05-11 15:50	26-06-11 15:50	60° 22.422 N	027° 32.874 E
Circles	Yes	27-05-11 12:20	Normal	26-05-11 15:50	26-06-11 15:50		
Line	No	27-05-11 12:40	Normal				
Text	Yes	27-05-11 13:03	Normal				
Depth	No	27-05-11 13:13	Normal				

Display options

Attachments Deleted Colored Timed objects

Press Save button.

Assigning “Attached File” Attribute

To assign “Attached file” attribute, the selected object should be plotted on chart.

To attach files (*.txt, *.rtf, *.bmp, *.doc, *.gif, *.jpg, *.tif, *.pdf) press the Edit objects button in the right-hand part of the panel.

From the drop-down list select **Attach.** item.

Type	Danger	Modified	State	Start time (UTC)	End time	Latitude	Longitude
Symbol	No	26-05-11 16:26	Normal	26-05-11 15:50	26-06-11	22.261 N	027° 35.066 E
Circles	Yes	27-05-11 12:20	Normal	26-05-11 15:50	26-06-11		
Line	No	27-05-11 12:40	Normal				
Text	Yes	27-05-11 13:03	Normal				
Depth	No	27-05-11 13:13	Normal				

Display options

Attachments Deleted Colored Timed objects

Edit objects menu: Edit, Shift, Shift All, Delete, Restore, Attach.

Position the acquisition marker , which will appear, on the object and press the left trackball button.

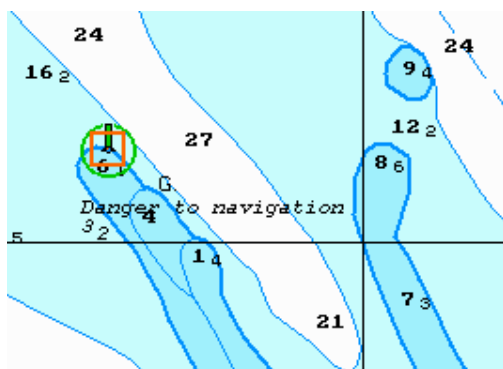

The screen will display a window with lists of all the files available for attaching (to view the contents of the selected file, press **View** button on the appropriate panel). The list of files available for attaching is formed in the Data Tool utility.



To attach a file (group of files) to the updating object, select it in **Available files** group and press **Attach >>** button.

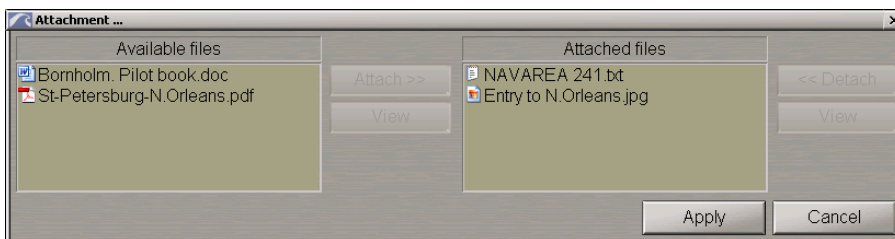

The file (group of files) will move to **Attached files** group.

To view the file contents select it and press **View** button.

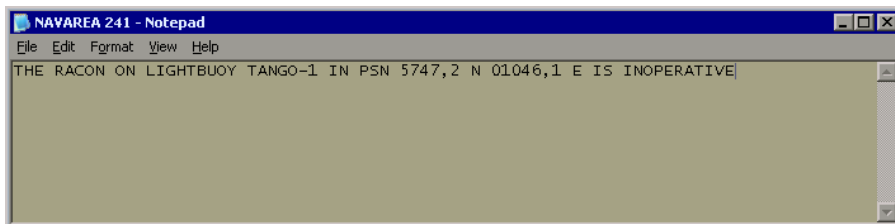

Press **Apply** button to confirm the changes you have made.

To detach a file (group of files), select the necessary files in **Attached files** group and press **<< Detach** button. The file (group of files) will move to **Available files** group. Press **Apply** button to confirm the changes you have made.

Press **Save** button.

Editing Updating Objects

Editing Updating Objects Attributes



Attention! Point type objects cannot be displayed on scales smaller than 1:600,000.

Open **Manual Correction** panel by selecting the appropriate line of **Tasks List** in the tabs zone of the ECDIS task screen.

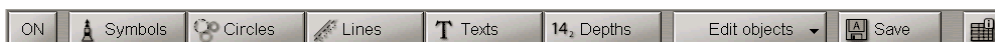

To turn on/off the display of updating objects on the ECDIS task screen press **ON** button.

Press the **Edit objects** button in the right-hand part of the panel. From the drop-down list select **Edit** item.

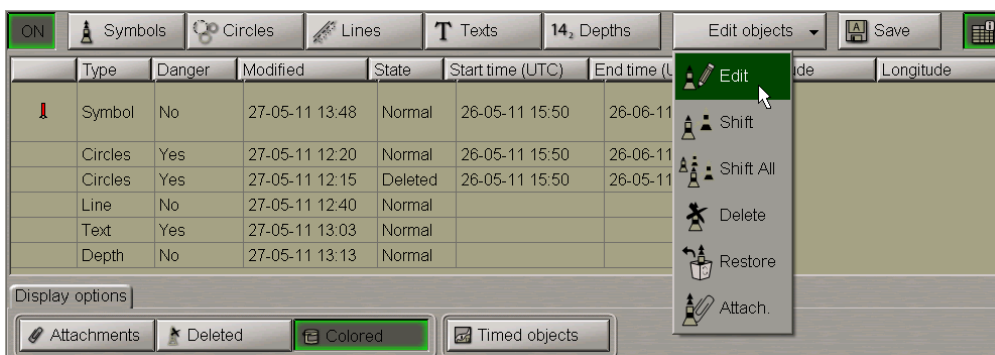

Position the acquisition marker , which will appear, on the object (in case of text objects, the acquisition point is the first character) and press the left trackball button.

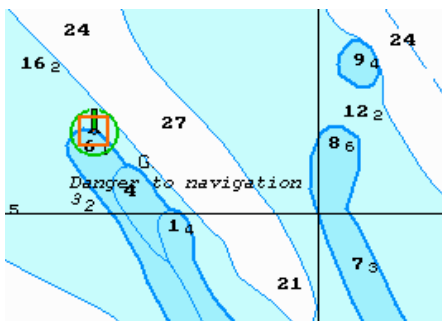

The bottom part of the screen will display a window for editing updating objects.





Edit the updating object parameters so as display time (“Temporary updating” attribute), text (“Text” attribute), required information (“Object information” attribute), “Danger to navigation” attribute and required depth value (“Object depth” attribute) (see paragraph *Plotting Point Type Object*).

Set the updating object colour (“Object colour” attribute). Select it from the **Color** palette (except for the point type objects).

Press **Edit** button in edition window to confirm the changes you have made.

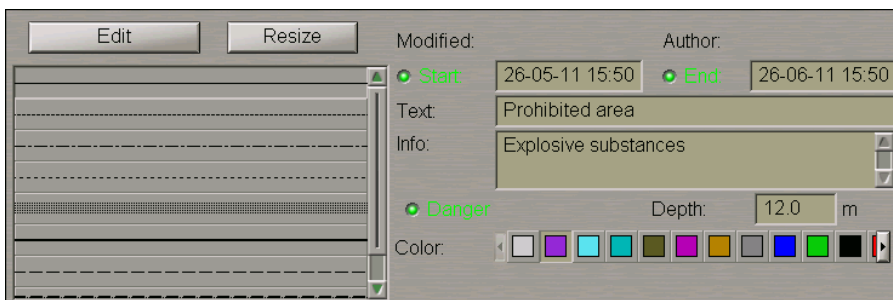
Parameters of the line and circle type objects are edited in much the same way. To resize line or circle type objects select this object as described above and press **Resize** button in edition window.



The graphic cursor  will appear on the first point of the selected line object.

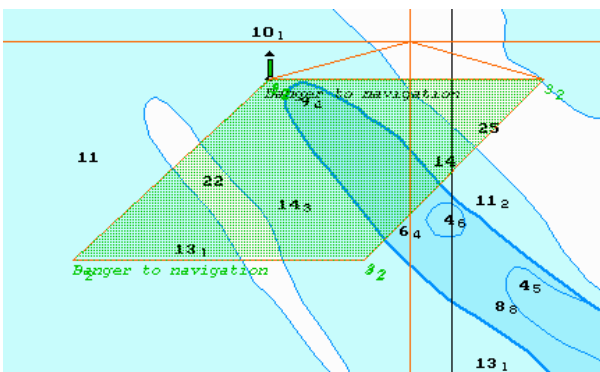

Move the cursor to the required coordinates. Press the left trackball button. Graphic cursor will change own form to acquisition marker.

Repeat this operation for other updating object boundaries until the necessary configuration is set.

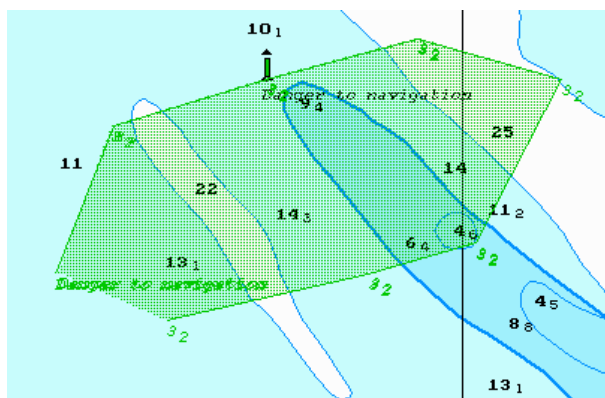

Press the right trackball button, all changes will be accepted.

Edit all necessary updating objects.

To exit from the editing mode press the right trackball button.

To attach/detach files to the updating object, see paragraph *Assigning "Attached File" Attribute*.

Press Save button.

The procedure of editing the updating object is completed.

Editing Object Coordinates



Attention! Point type objects cannot be displayed on scales smaller than 1:600,000.

Open **Manual Correction** panel by selecting the appropriate line of **Tasks List** in the tabs zone of the ECDIS task screen.

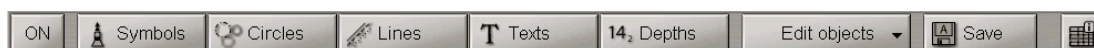

To turn on/off the display of updating objects on the ECDIS task screen press ON button.

Press the **Edit objects** button in the right-hand part of the panel. From the drop-down list select **Shift** item.

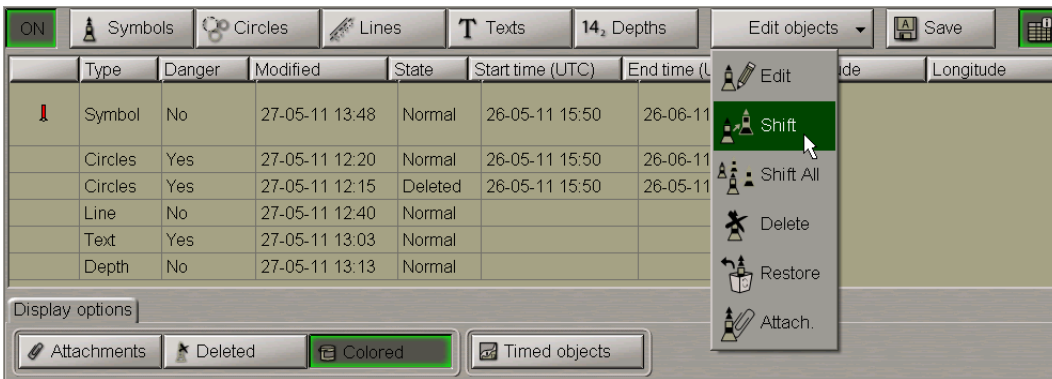

Position the acquisition marker  which will appear, on the object to be shifted (the first character of a text object or a point in a line or area type object).

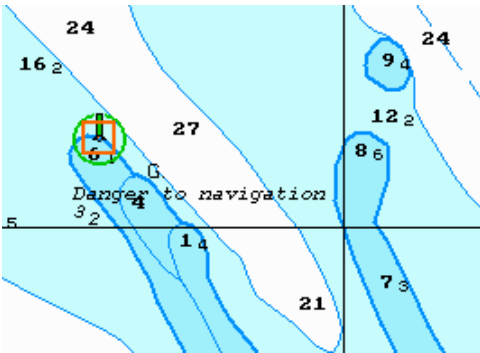

Press the left trackball button. Position the marker, which will appear, in the new object coordinates within the displayed Chart panel.

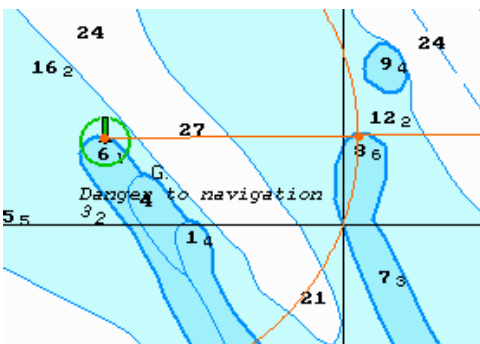

Press the left trackball button: the object will move to the specified coordinates.

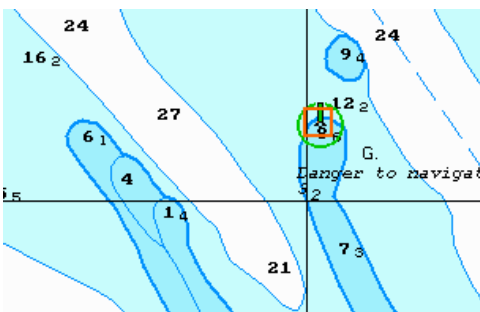

Press the right trackball button to exit from the editing mode of the updating object coordinates.

Press **Save** button.

You can use a similar procedure to change coordinates of all the updating objects by selecting the **Shift All** item from the drop-down list (to do this, it is necessary to enter the password).

Attention! In this case, all the updating objects of the layer will be shifted to the same distance and in the same direction as the object which is being edited.

Deleting Updating Object

Attention! Point type objects cannot be displayed on scales smaller than 1:600,000.

Open **Manual Correction** panel by selecting the appropriate line of **Tasks List** menu in the tabs zone of the ECDIS task screen.

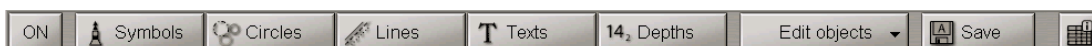
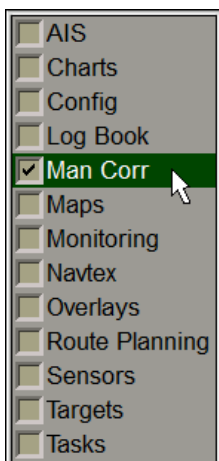

Press **ON** button.

Press the **Edit objects** button in the right-hand part of the panel. From the drop-down list select **Delete** item.

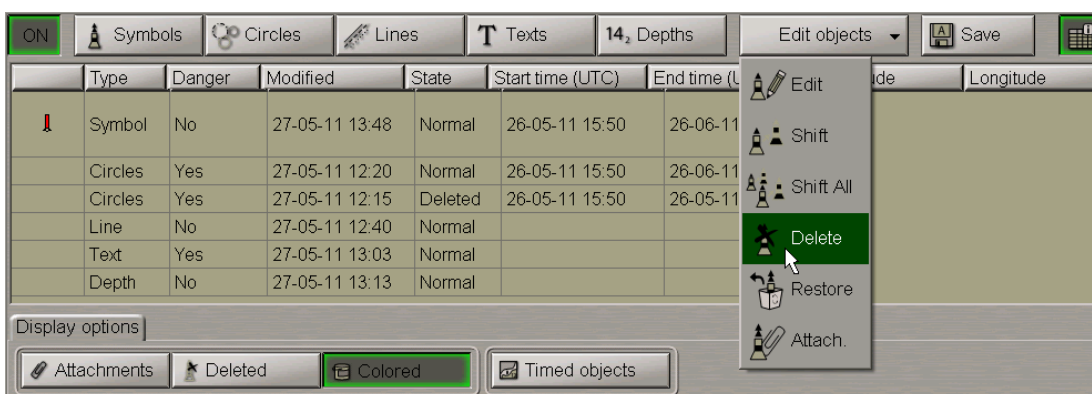

Position the acquisition marker, which will appear, on the object to be deleted (the first character of a text object or a point in a line or area type object).

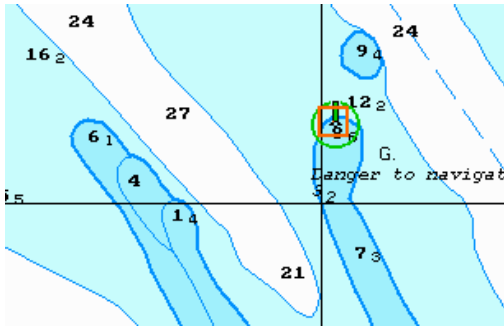

Press the left trackball button: the presentation of the object will be removed from the Chart panel.

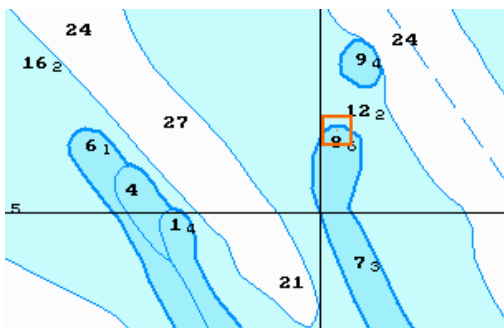

Press the right trackball button to exit from the updating object deleting mode.

Press Save button.

Restore the Deleted Object



Attention! Point type objects cannot be displayed on scales smaller than 1:600,000.

Open **Manual Correction** panel by selecting the appropriate line of **Tasks List** menu in the tabs zone of the ECDIS task screen.

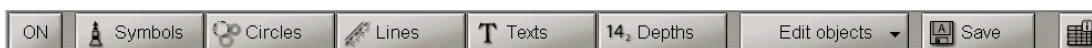
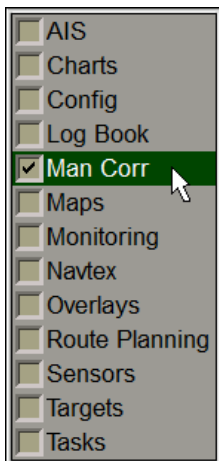

To turn on/off the display of updating objects on the ECDIS task screen press **ON** button.

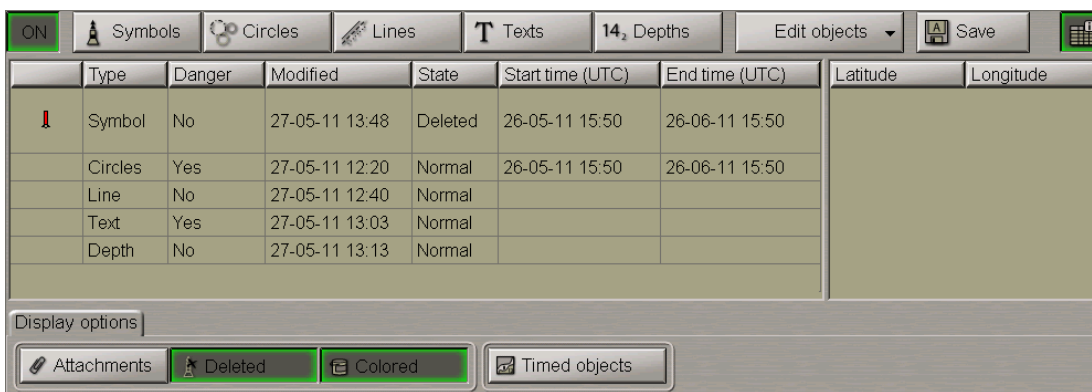

Press **Deleted** button in the **Display option** page. The screen will display all the previously deleted objects shown in the grey colour.

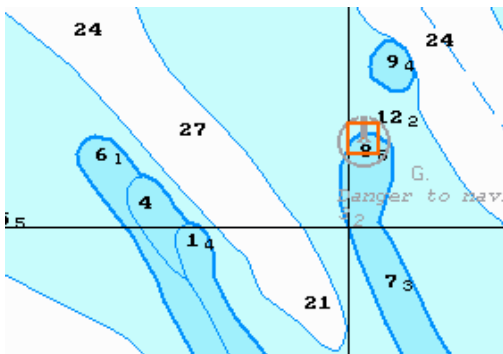

Press the **Edit objects** button in the right-hand part of the panel. From the drop-down list select **Restore** item.

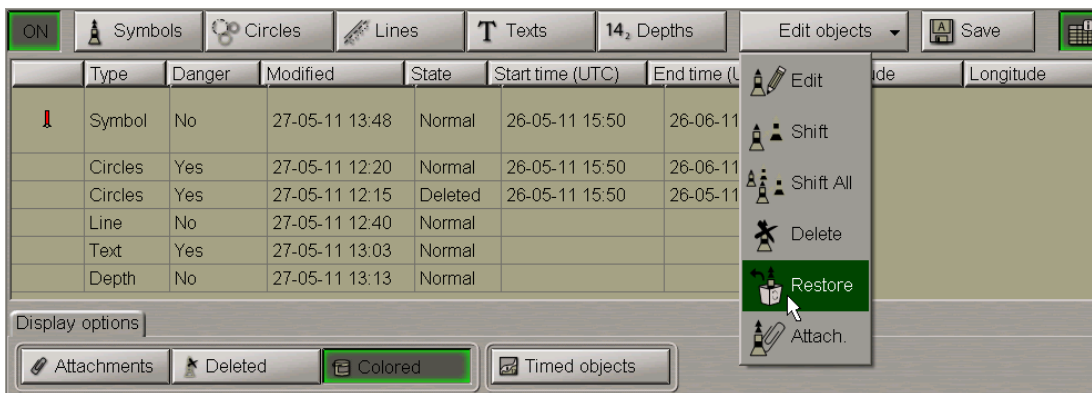

Position the acquisition marker, which will appear, on the deleted object (the first character of a text object or a corner point of a line or area type object).

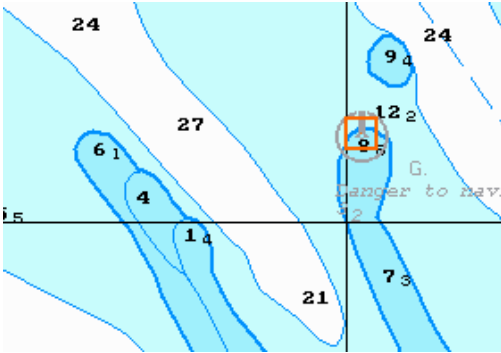

Press the left trackball button: “Deleted object” attribute is removed, and the object is highlighted in accordance with the previously made settings.

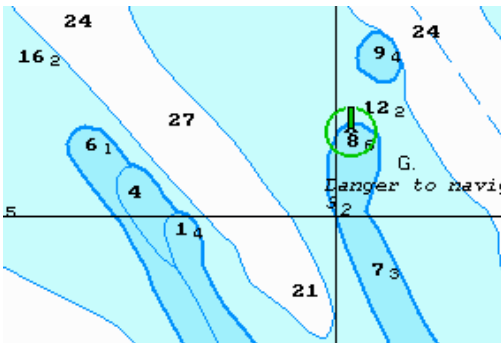

Press the right trackball button to exit from the deleted object restore mode.

Press Save button.

Search for Updating Objects



Attention! Point type objects cannot be displayed on scales smaller than 1:600,000.

Open **Manual Correction** panel by selecting the appropriate line of **Tasks List** menu in the tabs zone of the ECDIS task screen.

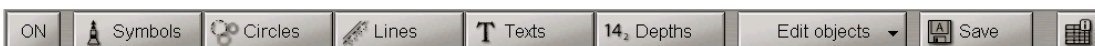
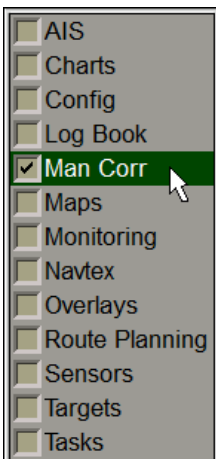

Press ON button.

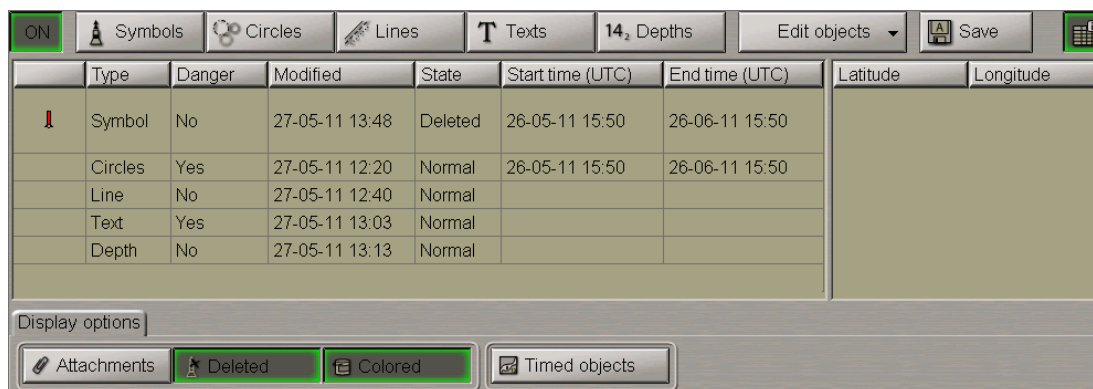

Select the required updating object in the left-hand part of the page and press the left trackball button. Coordinates of the selected object will be displayed in the right-hand part of the page.

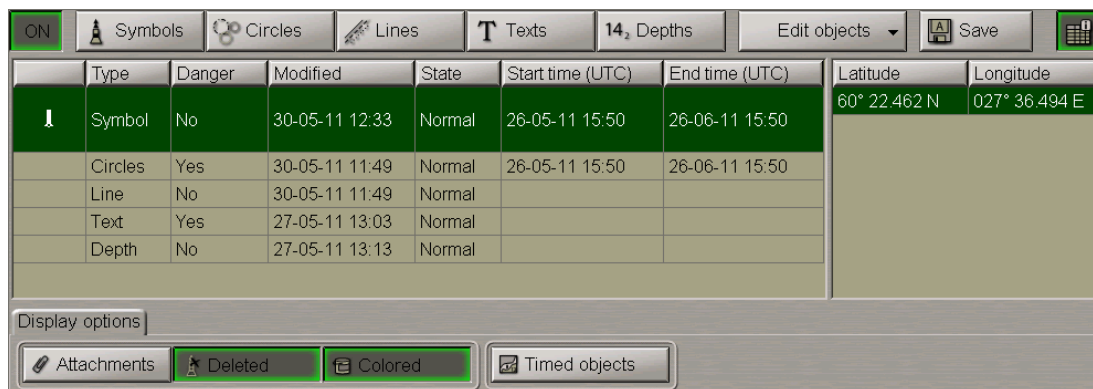

A double click of the left trackball button on the selected object line or its coordinates displays this object in the centre of the Chart panel highlighted with a flashing circle for 10 seconds.

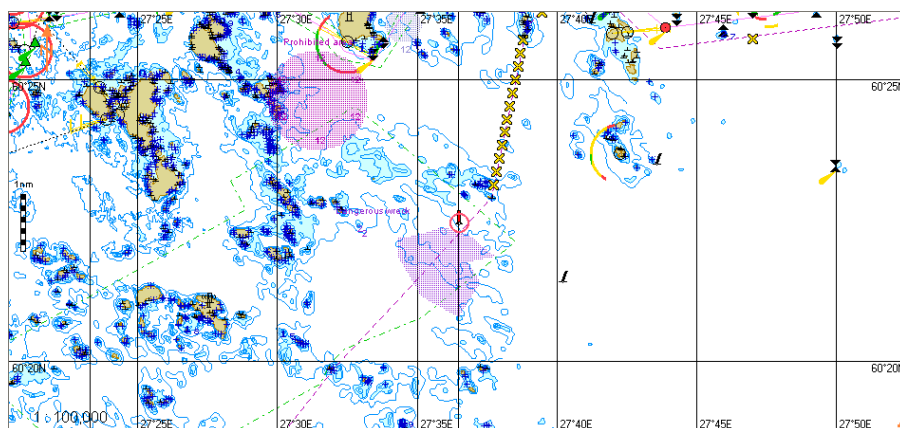

With the selection of line or area type objects, the right-hand part of the page displays coordinates of all the points, which the line/area type object consists of.

The screenshot shows a software interface with a toolbar at the top containing icons for Symbols, Circles, Lines, Texts, Depths, Edit objects, and Save. Below the toolbar is a table with the following data:

Type	Danger	Modified	State	Start time (UTC)	End time (UTC)	Latitude	Longitude
Symbol	No	30-05-11 12:33	Normal	26-05-11 15:50	26-06-11 15:50	60° 22.233 N	027° 35.847 E
Circles	Yes	30-05-11 11:49	Normal	26-05-11 15:50	26-06-11 15:50	60° 22.462 N	027° 36.494 E
Circles	Yes	27-05-11 12:15	Deleted	26-05-11 15:50	26-05-11 15:50	60° 22.464 N	027° 37.220 E
Line	No	30-05-11 12:45	Normal			60° 22.464 N	027° 38.454 E
Text	Yes	27-05-11 13:03	Normal				
Depth	No	27-05-11 13:13	Normal				

Below the table is a 'Display options' section with buttons for Attachments, Deleted, Colored, and Timed objects.

A double click of the left trackball button on the coordinates of any point which the line/area type object consists of, displays this point in the centre of the Chart panel highlighted with a flashing circle for 10 seconds.

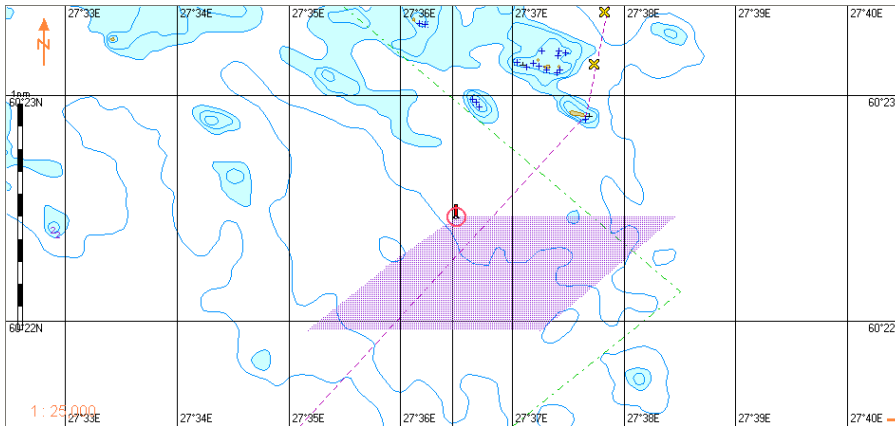

Chapter 8.

Handling of Maps

This chapter describes the procedure used in the handling of maps.

<u>Creating and Saving Maps</u>	236
Creating and Plotting Map Objects	238
Saving Map	255
Turning On/Off Display of Map Objects and Their Attributes	255
<u>Map Loading and Unloading for Editing</u>	256
<u>Map Loading and Unloading for Monitoring</u>	260
<u>Editing Map Objects</u>	263
Editing Map Object Attributes	263
Editing Map Object Coordinates	265
Deleting Map Object	267
Restoring Deleted Map Object	268
<u>Merging Maps</u>	269
<u>Deleting Maps</u>	272
<u>Search for Map Objects</u>	273
<u>Map Handling in Network Configuration</u>	274

Creating and Saving Maps

Attention! Symbol type objects cannot be displayed on scales smaller than 1:600,000.

Open the Maps panel by selecting the appropriate line of the **Tasks List** menu in the tabs zone of the ECDIS task screen.

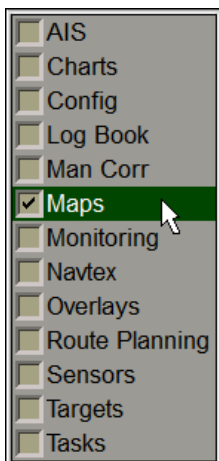

In **Maps** panel which will open up, press the  button in the top left part of the panel to turn on the maps display on the ECDIS task screen.

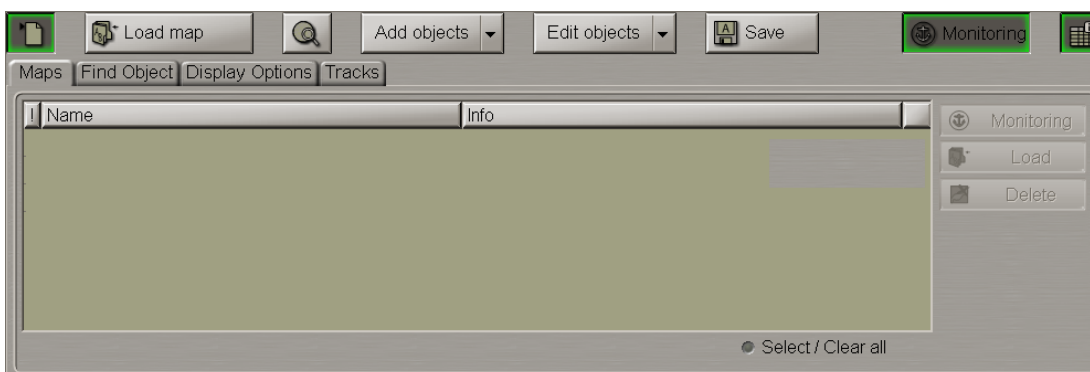

The map creating procedure consists of following stages:

- creation of map objects:
 - selection of the object category and type;
 - assigning of attributes to the object (except the “Attached files”);
 - plotting of an object;
 - assigning of the file “Attached file”; attribute
- saving the map.

Press the Loaded Maps button.

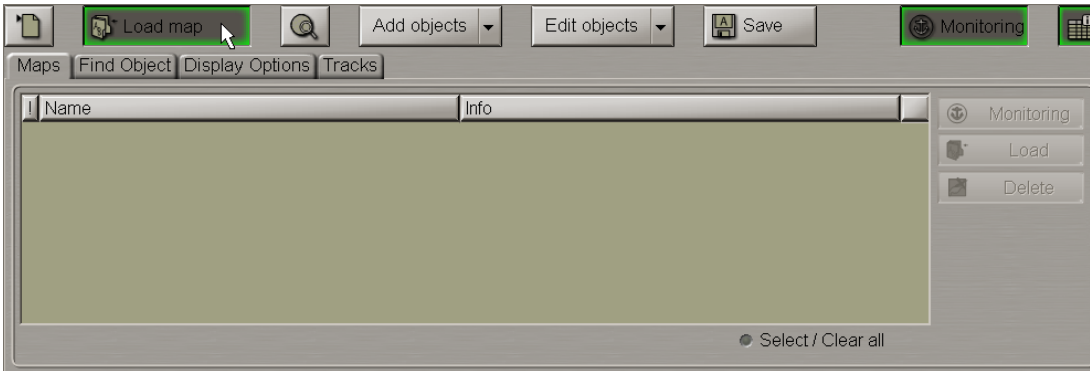

The drop-down list displays all the loaded maps.

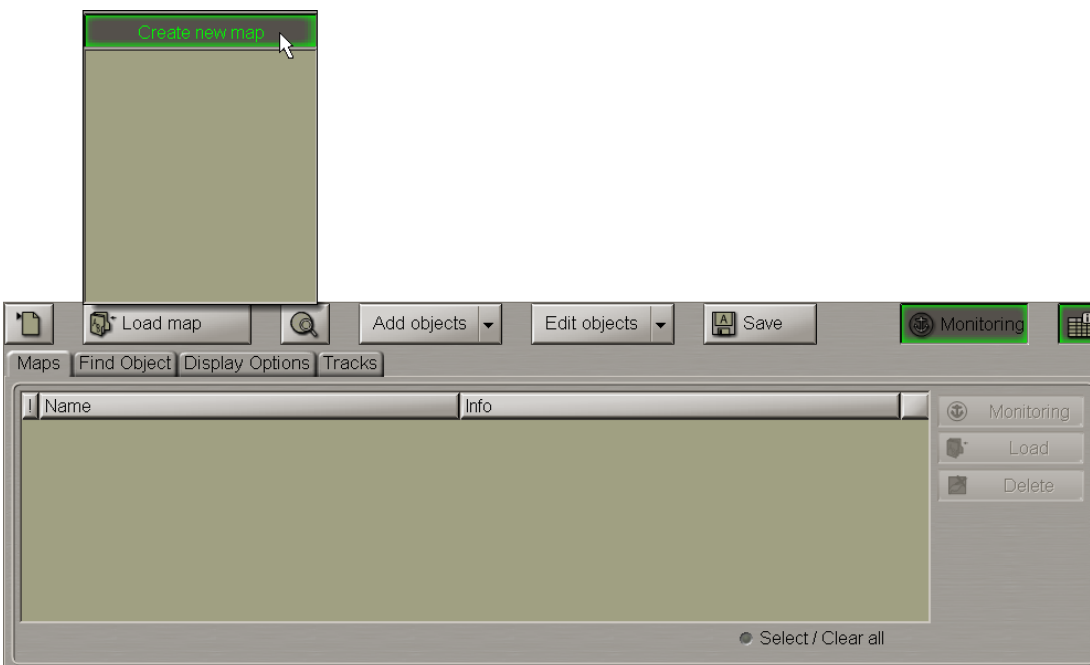

In the drop-down list press the Create new map button.

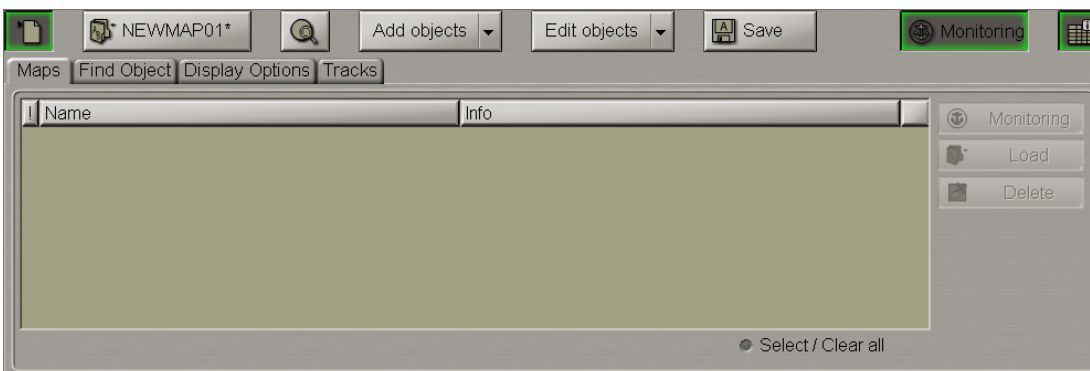

The map under the "NEWMAPXX*" name will be loaded.

Note: Next to the map name there is a "*" symbol which means that the map is edited but not saved. The unsaved maps are not synchronized with other WS's.

It is then necessary to plot on the map the map objects which may be of the following types:

- Symbol;
- Line;
- Text;
- Depth;
- Shapes.

Creating and Plotting Map Objects

Plotting Symbol Type Objects

Press the **Add objects** button.

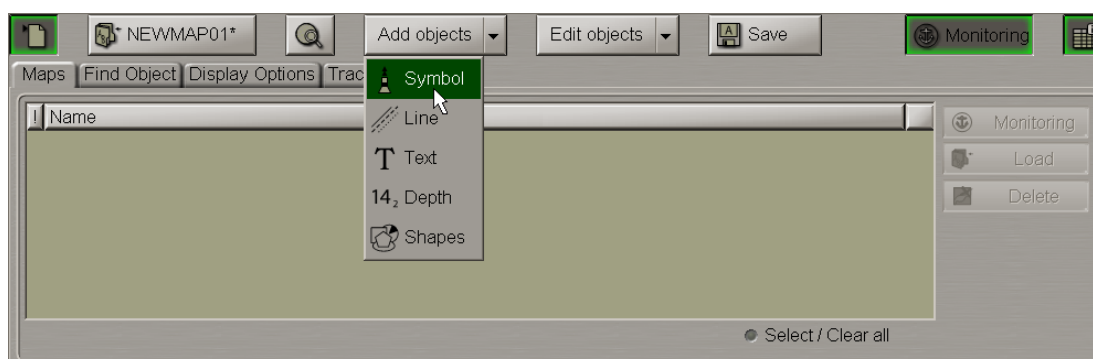

From the drop-down list select the **Symbol** item.

Note: In this case the map editing mode is automatically switched on, the **Monitoring** button in the top right corner switched to the **Editor** position.

Press the button with the name of current symbol library. From the drop-down list, select the symbol library:

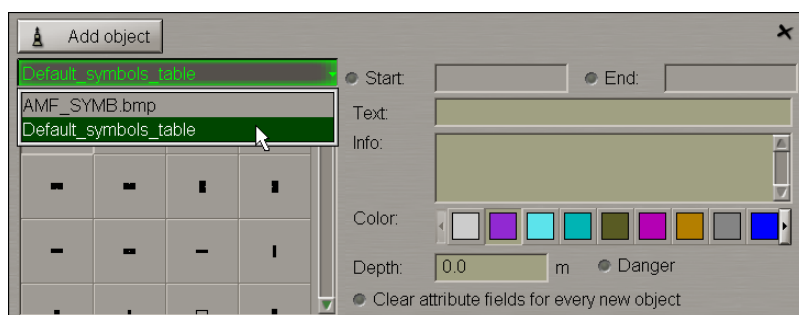

Select the map object symbol type from the table and press the left trackball button.

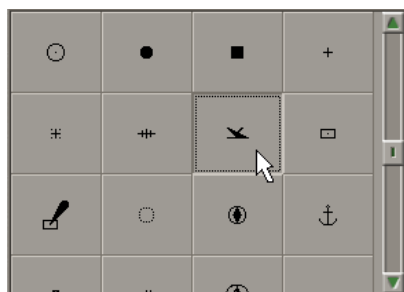

Set the display time (“Temporary”) attribute. To do this, check the **Start** checkbox. Use the trackball to set the start date and time of the map object display and press the right trackball button.

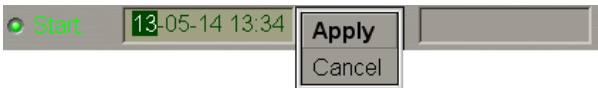

Press the “Apply” button to confirm the changes you have made.

Check the End checkbox and set the map object display end date and time.

Set the map object colour (“Object colour” attribute). Select it from the **Color** palette.



Enter the required text (“Text” attribute) in the Text input line (information will be displayed on the map).

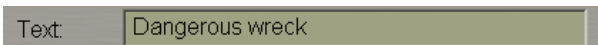

Enter the required information (“Object information” attribute) in the Info field (information will not be displayed unless the Info function is used).

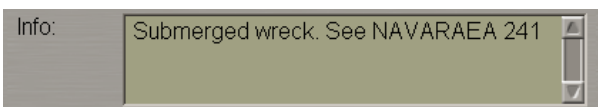

Set the required depth value (the “Object depth” attribute) in the Depth line.

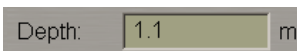

Check the Danger checkbox (the “Danger to navigation” attribute) as required.



Files are attached (the “Attached file” attribute) after the plotting of map object.

To plot a map object on the chart, press the **Add object** button.

The graphic cursor  will appear on the Chart Panel, whereas the right bottom part of the screen will display the **Add Symbol** information window with cursor coordinates.



Position the cursor, which will appear on the graphic screen in the required coordinates.

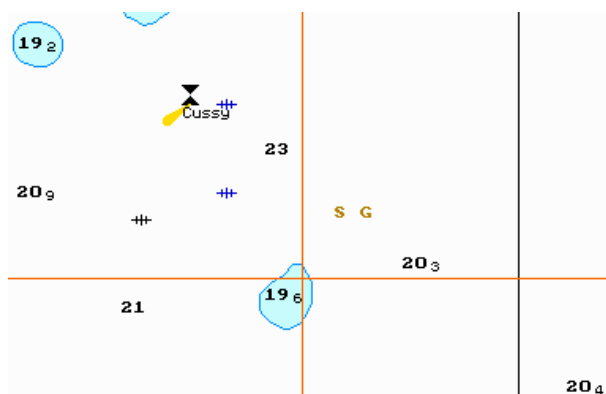

Press the left trackball button: the symbol type object will be set in the specified coordinates.



Press the right trackball button to exit from the editing mode. The cursor will assume the shape of the ECDIS task free cursor.

Switch to the **Find Object** page. Information on the plotted map object will be displayed in the table on this page.

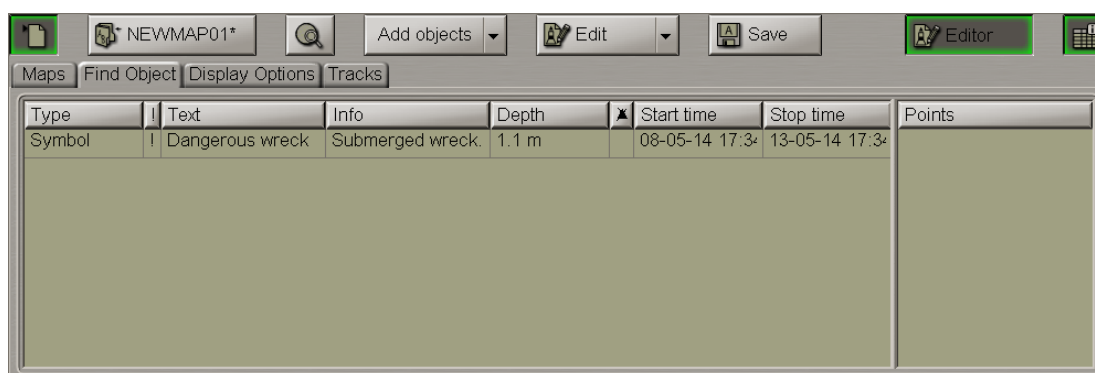

Plotting Lines

Press the **Add objects** button.

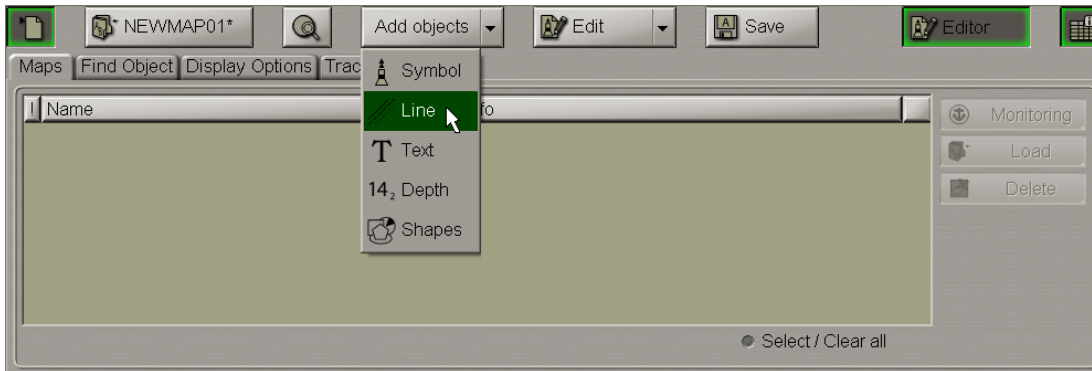

From the drop-down list select the **Line** item.

Select the type of line type map object from the table.

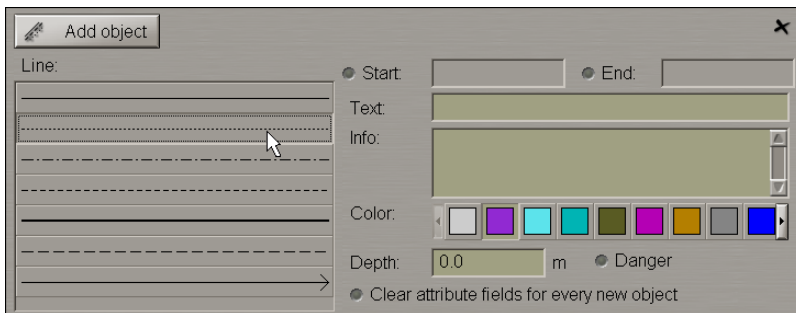

Set the map object colour (the “Object colour” attribute), the map object display time (the “Temporary” attribute), the map object text (the “Text” attribute), the necessary information (the “Object information” attribute), the “Danger to navigation” attribute and the required depth value (the “Object depth” attribute) (see item *Plotting Symbol Type Objects*).

Files are attached (the “Attached file” attribute) after the plotting of the map object.

To plot a map object on the chart, press the **Add object** button.

The graphic cursor  will appear on the Chart Panel, whereas the right bottom part of the screen will display the **Add Line** information window with cursor coordinates.



Position the cursor in the initial point and press the left trackball button.

To set lines and areas, after the plotting of the initial point, move the cursor to the next point and press the left button again. Repeat the procedure until you set the required number of point.

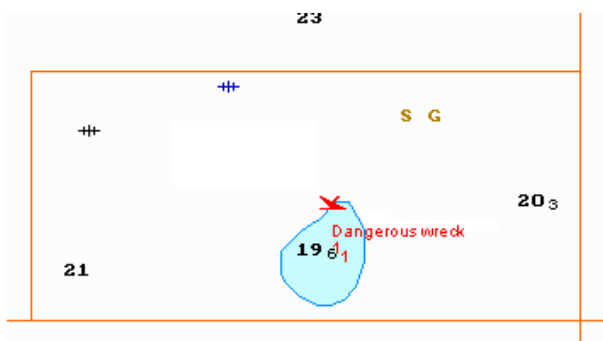

After the input of the last point of a line or area, press the right trackball button: the cursor will change its form, and the object will be set in the specified coordinates:

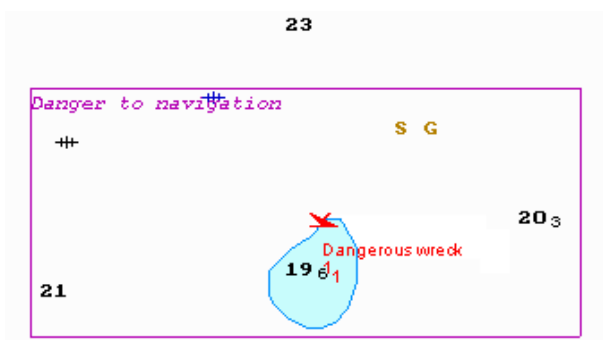

Switch to the **Find Object** page. Information on the plotted user map object will be displayed in the table on this page.

NEWMAP01*

Line Edit objects Save Editor

Maps Find Object Display Options Tracks

Type	Text	Info	Depth	X	Start time	Stop time	Points
Symbol	Dangerous wreck	Submerged wreck.	1.1 m		08-05-14 17:32	13-05-14 17:32	
Line	Danger to navigatic				14-05-14 17:32	20-05-14 17:32	

Plotting Text Object

Press the **Add objects** button.

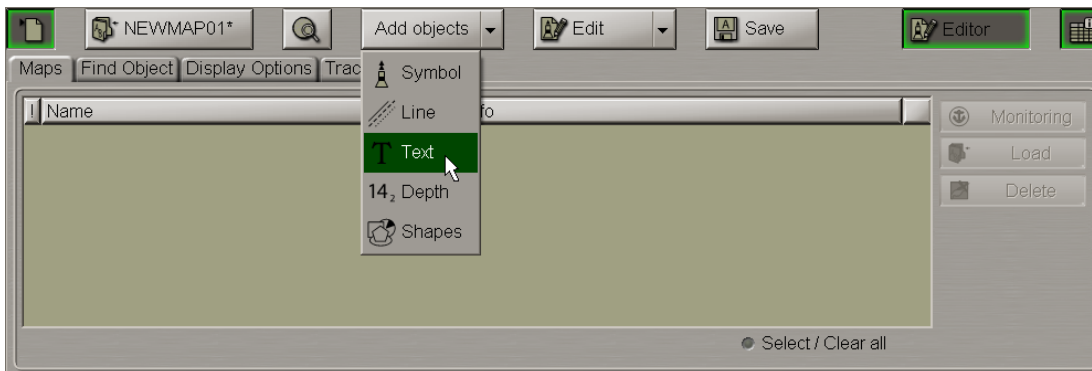

From the drop-down list select the **Text** item.

In the **Text** input window enter the necessary text.

 A screenshot of a dialog box titled 'Add object' with a 'T' icon. It contains several input fields: 'Start' (04-05-14 13:34), 'End' (08-07-14 13:34), 'Text' (Dangerous wreck), 'Info' (empty text area), 'Color' (a row of color swatches), 'Depth' (0.0 m), and a radio button for 'Danger'. At the bottom, there is a checkbox labeled 'Clear attribute fields for every new object'.

Set the map object colour (the “Object colour” attribute), the map object display time (the “Temporary” attribute), required information (the “Object information” attribute), the “Danger to navigation” attribute and the required depth value (the “Object depth” attribute) (see item *Plotting Symbol Type Objects*).

Files are attached (the “Attached file” attribute) after the plotting of a map object.

To plot a map object on the chart, press the **Add object** button.

The graphic cursor  will appear on the Chart Panel, whereas the right bottom part of the screen will display the **Add Text** information window with cursor coordinates.

 A screenshot of a dialog box titled 'Add Text'. It contains input fields for 'Latitude' (51°20.012' N) and 'Longitude' (001°28.227' E). Below these is a section for 'Ship position' with radio buttons for 'true' and 'relative'. It also has input fields for 'Bearing' (224.8), 'Opp. Bearing' (044.8), and 'Range' (500.55 NM). At the bottom, there is a button that says 'Press Tab to edit manually'.

Position the cursor in the required coordinates.

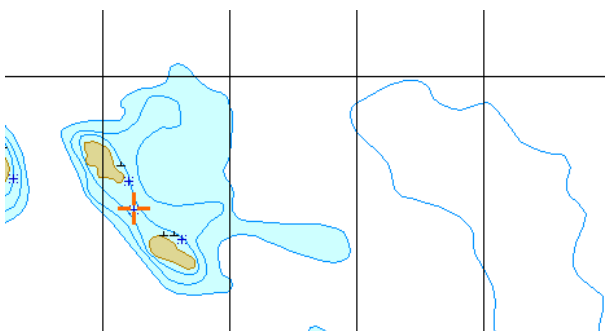

Press the left trackball button: the text type map object will be set in the specified coordinates.

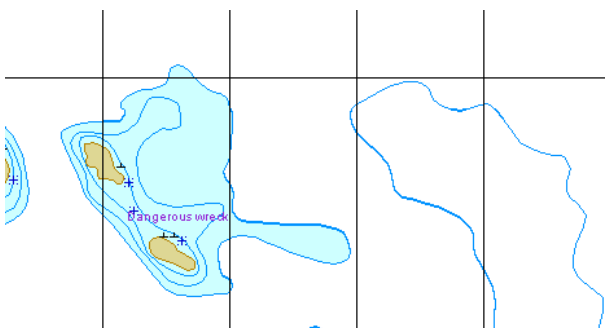

Press the right trackball button to exit from the editing mode. The cursor will assume the shape of the ECDIS task free cursor.

Switch to the **Find Object** page. Information on the plotted map object will be displayed in the table on this page.

Type	Text	Info	Depth	X	Start time	Stop time	Points
Symbol	Dangerous wreck	Submerged wreck.	1.1 m		08-05-14 17:3	13-05-14 17:3	
Text	Dangerous wreck				04-05-14 17:3	08-07-14 17:3	
Line	Danger to navigatic				14-05-14 17:3	20-05-14 17:3	

Plotting Depth Object

Press the Add objects button.

Name	Info	Depth	X	Start time	Stop time	Points

From the drop-down list select the **Depth** item.

In the **Depth** input window enter the necessary depth.

14 Add object

Start: 06-05-14 13:34 End: 14-07-14 13:34

Text:

Info:

Color:

Depth: 2.2 m Danger

Clear attribute fields for every new object

Set the map object colour (the “Object colour” attribute), the map object display time (the “Temporary” attribute), map object text (the “Text” attribute), required information (the “Object information” attribute), the “Danger to navigation” attribute and the required depth value (the “Object depth” attribute) (see item *Plotting Symbol Type Objects*).

Files are attached (the “Attached file” attribute) after the plotting of a map object. Files are attached (the “Attached file” attribute) after the plotting of the map object.

To plot a map object on the chart, press the **Add object** button.

The graphic cursor  will appear on the Chart Panel, whereas the right bottom part of the screen will display **Add Depth** information window with cursor coordinates.

Add Depth

Latitude: 60°22.422' N

Longitude: 027°32.889' E

Ship position: true relative

Bearing: 111.0  179.8 °

Opp. Bearing: 291.0  000.2 °

Range: 308.03 NM

Press Tab to edit manually

Position the cursor in the required coordinates.

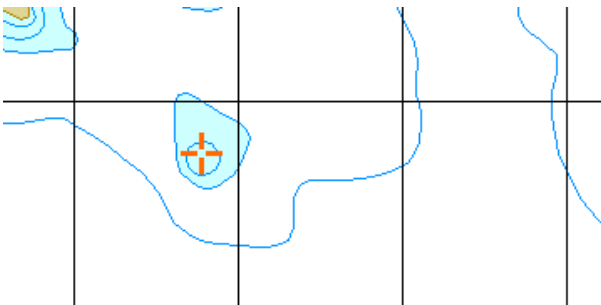

Press the left trackball button: the depth type map object will be set in the specified coordinates.

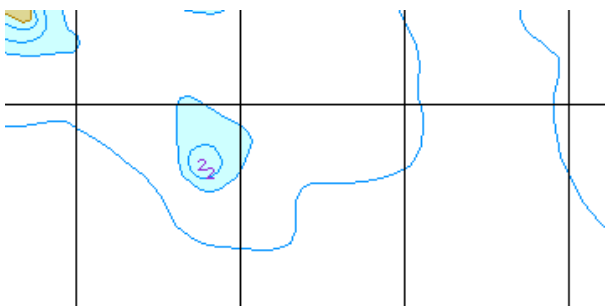

Press the right trackball button to exit from the editing mode. The cursor will assume the shape of the ECDIS task free cursor.

Switch to the **Find object** page. Information on the plotted map object will be displayed in the table on this page.

Type	Text	Info	Depth	X	Start time	Stop time	Points
Symbol	Dangerous wreck	Submerged wreck.	1.1 m		08-05-14 17:3	13-05-14 17:3	
Depth			2.2 m		06-05-14 17:3	14-07-14 17:3	
Text	Dangerous wreck				04-05-14 17:3	08-07-14 17:3	
Line	Danger to navigatic				14-05-14 17:3	20-05-14 17:3	

Plotting Shapes

Press the **Add objects** button.

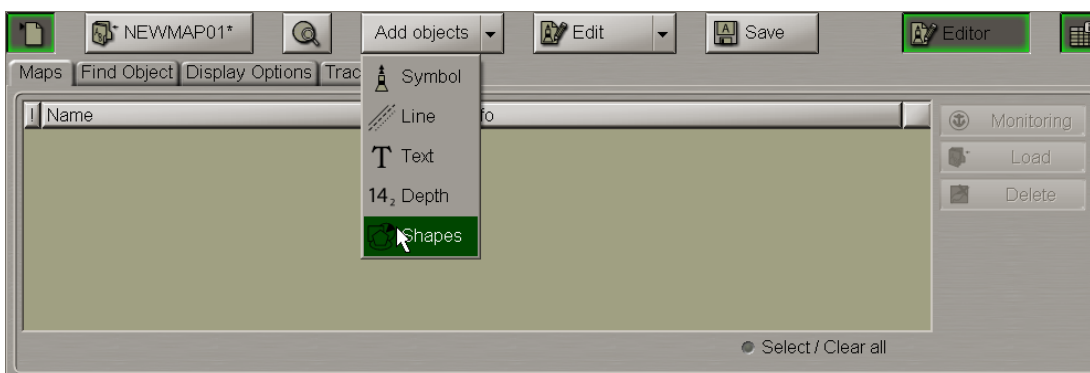

From the drop-down list select the **Shapes** item.

Select from the table the type of the line (**Line**) delineating the shape and of the shape infill (**Fill**):

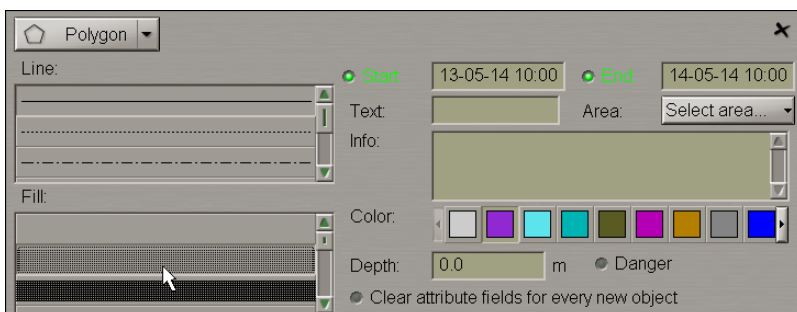

Set the map object colour (“Object colour” attribute), the map object display time (“Temporary” attribute), map object text (the “Text” attribute), required information (the “Object information” attribute), the “Danger to navigation” attribute and the required depth value (the “Object depth” attribute) (see item *Plotting Symbol Type Objects*).

Files are attached (the “Attached file” attribute) after the plotting of the map object

Press the button in the top left corner to select the form of a shape to be plotted.

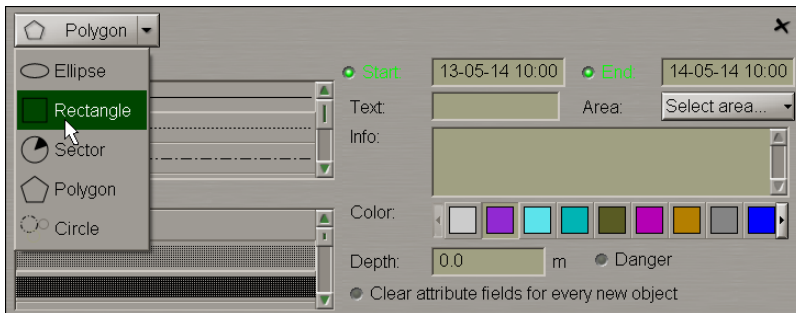

Select the necessary shape from the list. Press the same button again.

Depending on the selected shape, plot the shape type map object making additional settings as required:

- Ellipse:

The graphic cursor  will appear on the Chart Panel, whereas the right bottom part of the screen will display the Add Ellipse information window with cursor coordinates.

Add Ellipse

Latitude

Longitude

Ship position

	true	relative
Bearing	<input type="text" value="227.8"/>	<input type="text" value="011.3"/> °
Opp. Bearing	<input type="text" value="047.8"/>	<input type="text" value="168.7"/> °
Range	<input type="text" value="1.75"/> NM	
	<input type="text" value="3246"/> m	

Press Tab to edit manually

Position the cursor in the central point and press the left trackball button.

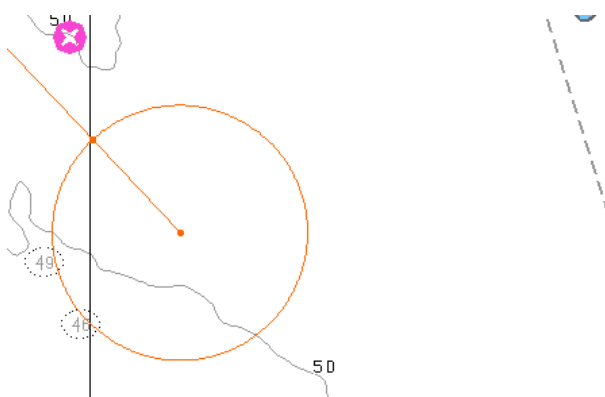

After this, by moving the cursor set the necessary length of the major axis and press the left trackball button again.

Ellipse parameters	
Position:	58°08.055' N 021°09.021' E
Major axis:	3.000
Minor axis:	1.500
Start angle:	40
End angle:	90
Rotation angle:	0
Apply	

Make (correct) additional settings:

- **Major axis** – length of the ellipse major axis;
- **Minor axis** – length of the ellipse minor axis;
- **Start angle** – initial angle of the ellipse display sector relative to the minor axis;
- **End angle** – final angle of the ellipse display sector relative to the minor axis;
- **Rotation angle** – ellipse turn angle relative to the north.

Press the Apply button.

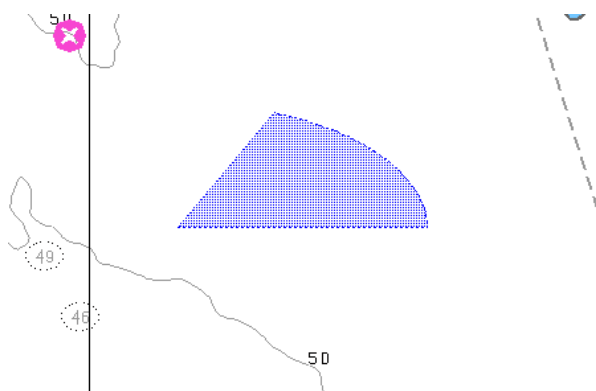

Press the right trackball button to exit from the editing mode. The cursor will assume the shape of the ECDIS task free cursor.

- Rectangle:

The graphic cursor  will appear on the Chart Panel, whereas the right bottom part of the screen will display the **Add Rectangle** information window with cursor coordinates.

Add Rectangle	
Latitude	57°03.741' N
Longitude	018°31.900' E
Ship position	
	<input type="radio"/> true <input type="radio"/> relative
Bearing	267.8 <input type="text"/> 051.3  °
Opp. Bearing	087.8 <input type="text"/> 128.7  °
Range	2.41 <input type="text"/> NM
	4472 <input type="text"/> m
Press Tab to edit manually	

Position the cursor in the initial point and press the left trackball button.

To set the rectangle shape, after the plotting of the initial point, move the cursor so as to construct a rectangle of the necessary form and press the left button again.

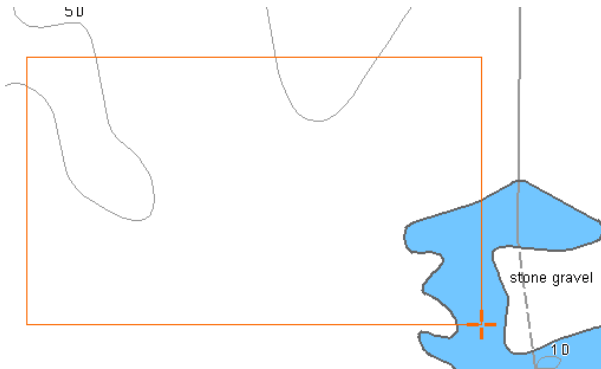

After the input of the last point of the rectangle shape, press the right trackball button: the cursor will change its form and the object will be set in the specified coordinates:

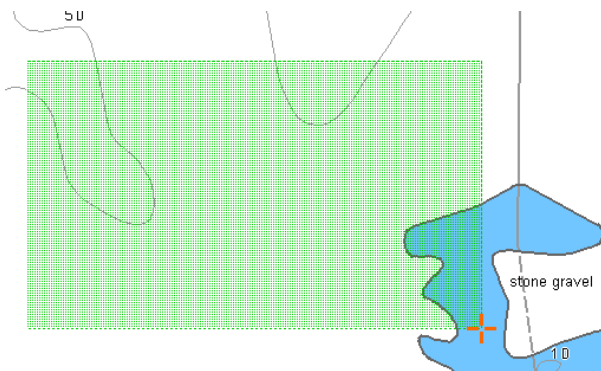

Press the right trackball button to exit from the editing mode. The cursor will assume the shape of the ECDIS task free cursor.

- Sector:

The graphic cursor  will appear on the Chart Panel, whereas the right bottom part of the screen will display the **Add Sector** information window with cursor coordinates.

Add Sector	
Latitude	57°05.769' N
Longitude	018°30.709' E
Ship position	
	<input type="radio"/> true <input type="radio"/> relative
Bearing	317.8 101.3  °
Opp. Bearing	137.8  078.7 °
Range	3.69 NM
	6828 m
Press Tab to edit manually	

Position the cursor in the central point of the sector and press the left trackball button.

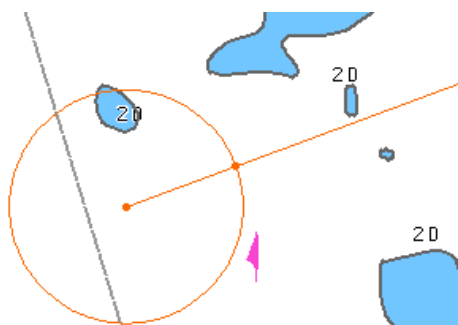

After this, by moving the cursor set the necessary radius and press the left trackball button again.

Sector parameters	
Position:	58°12.103' N 021°27.012' E
Internal radius:	0.059
External radius:	1.468
Start angle:	0
End angle:	90
<input type="button" value="Apply"/>	

Make (correct) the necessary settings:

- **Internal radius** – length of the sector internal radius;
- **External radius** – length of the sector external radius;
- **Start angle** – initial angle of the display sector relative to the North;
- **End angle** – final angle of the display sector relative to North.

Press the **Apply** button.

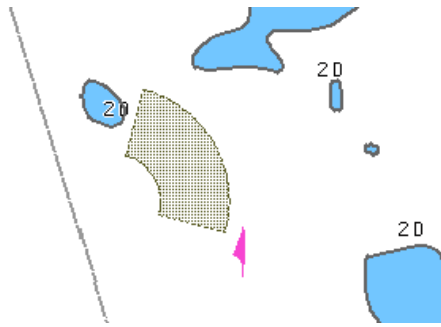

Press the right trackball button to exit from the editing mode. The cursor will assume the shape of the ECDIS task free cursor.

- **Polygon:**

The graphic cursor  will appear on the Chart Panel, whereas the right bottom part of the screen will display the **Add Polygon** information window with the cursor coordinates.

Add Polygon	
Latitude	57°08.309' N
Longitude	018°24.477' E
Ship position	
	<input type="radio"/> true <input type="radio"/> relative
Bearing	315.8 099.3 °
Opp. Bearing	135.8 080.7 °
Range	7.97 NM
	14755 m
Press Tab to edit manually	

Position the cursor in the initial point of the polygon shape and press the left trackball button.

To set the polygon shape, after the plotting of the initial point, move the cursor to the next point and press the left button again. Repeat the procedure until you set the required number of point.

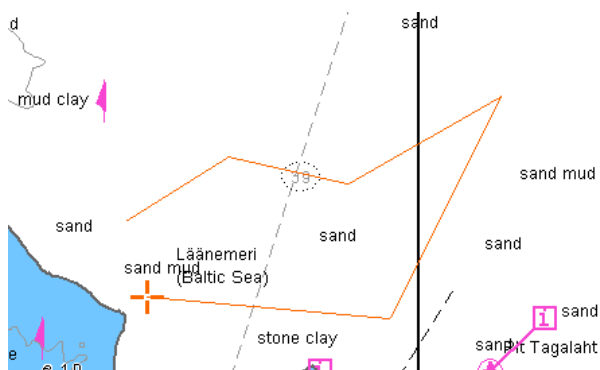

After the input of the last point of the polygon shape, press the right trackball button: the cursor will change its form and the object will be set in the specified coordinates, the first and the last point of the plotted polygon connected automatically:

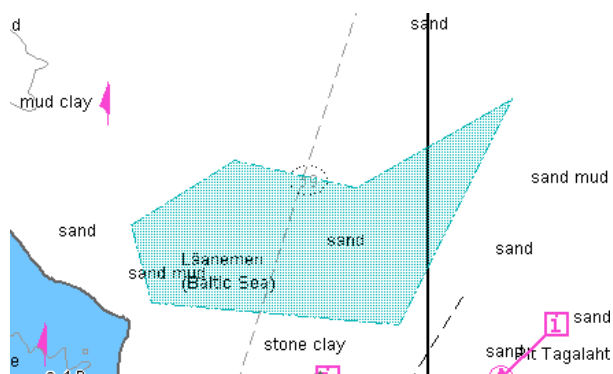

Press the right trackball button to exit from the editing mode. The cursor will assume the shape of the ECDIS task free cursor.

- Circle:

The graphic cursor  will appear on the Chart Panel, whereas the right bottom part of the screen will display the Add Circle information window with the cursor coordinates.

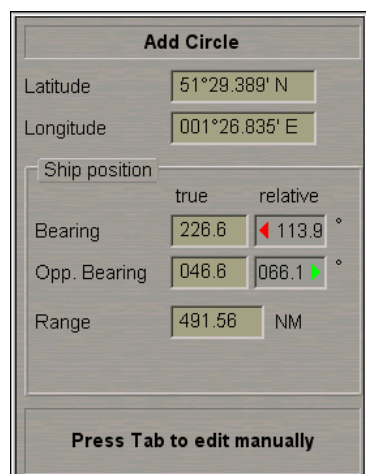

Position the cursor in the central point and press the left trackball button.

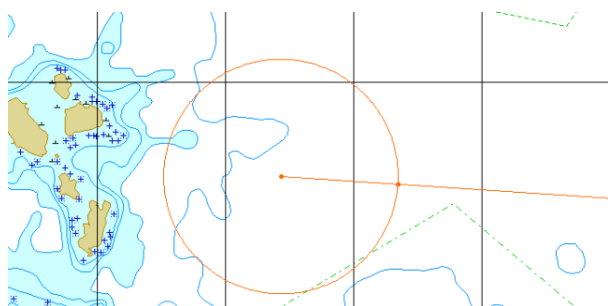

After this, move the cursor to the necessary radius and press the left trackball button again.

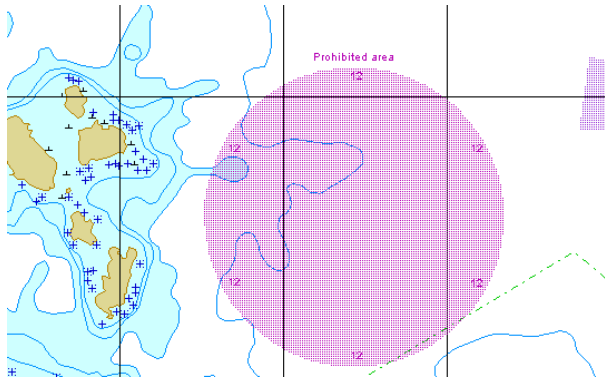

Press the right trackball button to exit from the editing mode. The cursor will assume the shape of the ECDIS task free cursor.

Switch to the **Find object** page. Information on the plotted map objects will be displayed in the table on this page.

Type	Text	Info	Depth	X	Start time	Stop time	Points
Symbol	Dangerous wreck	Submerged wreck.	1.1 m		08-05-14 17:32	13-05-14 17:32	
Depth			2.2 m		06-05-14 17:32	14-07-14 17:32	
Text	Dangerous wreck				04-05-14 17:32	08-07-14 17:32	
Line	Danger to navigatic				14-05-14 17:32	20-05-14 17:32	
Polygon					14-05-14 14:00	15-05-14 14:00	
Circle					14-05-14 14:00	15-05-14 14:00	
Ellipse		Danger for navigati			14-05-14 14:00	15-05-14 14:00	
Sector					14-05-14 14:00	15-05-14 14:00	
Rectangle		Danger for navigati			14-05-14 14:00	15-05-14 14:00	

Assigning “Attached File” Attribute

Press the  button. Switch to the **Find object** page. Double click on the necessary map object. To be assigned with the “Attached file” attribute, the selected object should be plotted on the chart.

To attach files (*.txt, *.rtf, *.bmp, *.doc, *.gif, *.jpg, *.tif, *.pdf), press the **Edit objects** button in the right-hand part of the panel.

From the drop-down list select the **Attach** item.

Type	Text	Info	Depth	X	Start time	Stop time	Points
Symbol	Danger to navigatic		1.1 m				
Depth	Dangerous wreck		1.1 m				
Text		Danger					
Line							
Polygon							
Circle							
Ellipse		Danger for navigati					
Sector							
Rectangle		Danger for navigati					

Position the  acquisition marker, which will appear, on the object and press the left trackball button.



The screen will display a window with lists of all the files available for attaching (to view the contents of the selected file, press the **View** button on the appropriate panel).

The list of files available for attaching is formed in the Data Tool utility.



To attach a file (group of files) to the map object, select it in the **Available files** group and press the **Attach >>** button.

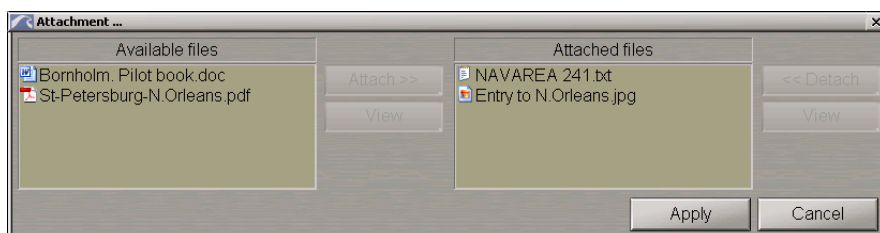

The file (group of files) will move to the **Attached files** group.

To view the file contents select it and press the **View** button.

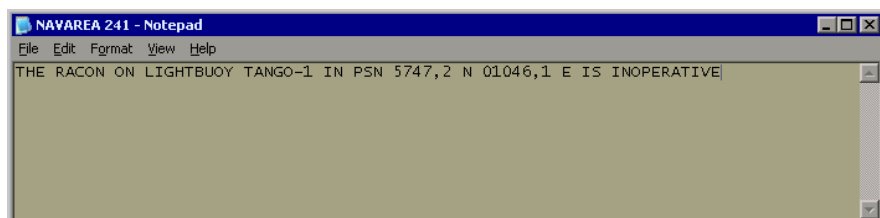

Press the **Apply** button to confirm the changes you have made.

To detach a file (group of files), select the necessary files in the **Attached files** group and press the **<< Detach** button. The file (group of files) will move to the **Available files** group. Press the **Apply** button to confirm the changes you have made.

Saving Map

Use the procedure detailed above to create and plot the required number of map objects.

Press the **Save** button.

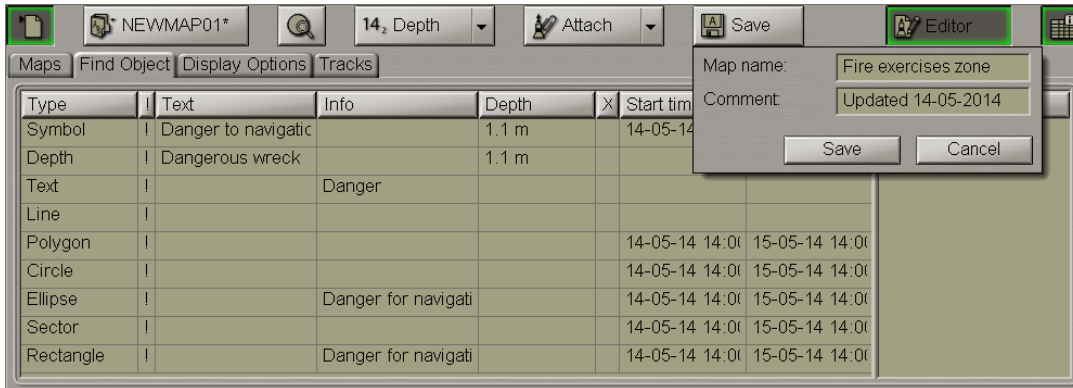

In the window, which will open up, in the **Chart name** input line enter the map name. In the **Comment** input line enter comments on the created map as required. Press **Save** button in the window, the map will be saved.



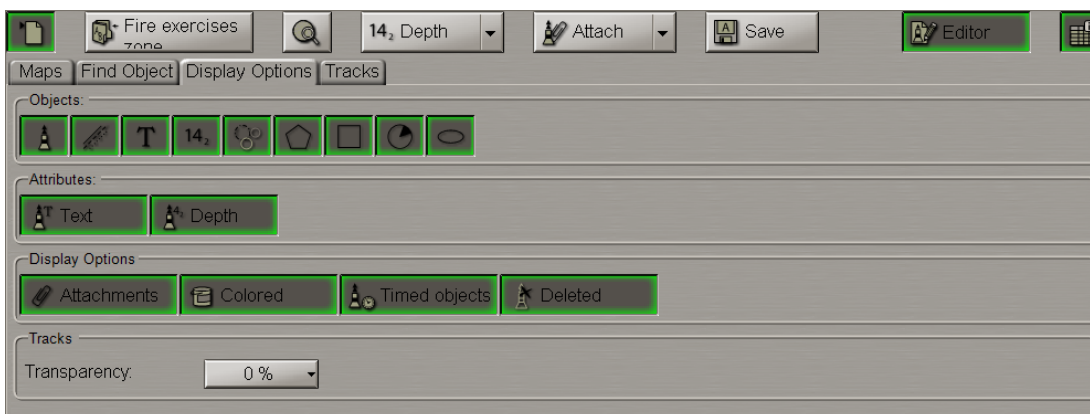

Turning On/Off Display of Map Objects and Their Attributes





To turn on/off the display of map object categories on the ECDIS task screen, switch to the **Display options** page.



By default, all buttons are depressed.

To turn on/off the display of various map object categories on the ECDIS task screen, press the following buttons in the **Objects** group:

-  – to turn on the display of all the "Symbol" category objects;
-  – to turn on the display of all the "Line" category objects;
-  – to turn on the display of all the "Text" category objects;
-  – to turn on the display of all the "Depth" category objects;

-  – to turn on the display of all the "Circle" category objects;
-  – to turn on the display of all the "Polygon" category objects;
-  – to turn on the display of all the "Rectangle" category objects;
-  – to turn on the display of all the "Sector" category objects;
-  – to turn on the display of all the "Ellipse" category objects.

To turn on/off the display of various map object attributes on the ECDIS task screen, press the following buttons in the **Attributes** group:

- **Texts** – to turn on the display of the "Text" attributes;
- **Depths** – to turn on the display of the "Depth" attributes.

To turn on/off the display of other map object attributes on the ECDIS task screen, press the following buttons in the **Display options** group:

- **Attachments** – to turn on the highlighting of objects with attached files;
- **Colored** – to turn on the display of the map object colour. With the button disabled, all the map objects are shown in orange;
- **Timed objects** – to turn on the display of temporarily appearing objects, if the button is depressed these objects are always visible, if it is released, they are not visible until they become effective;
- **Deleted** – to turn on the highlighting of a deleted object.

Map Loading and Unloading for Editing



Attention! In this mode, maps are loaded for editing only. In the editing mode, there is no tracking of map objects with the "Danger" attribute. This is what the monitoring mode is intended for (see the next paragraph).

Open the **Maps** panel by selecting the appropriate line of the **Tasks List** menu in the tabs zone of the ECDIS task screen.

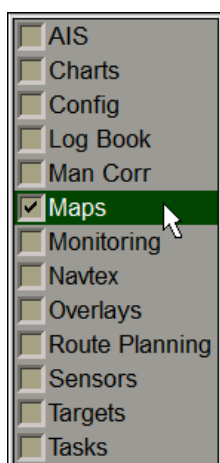

Use the tab in the top part of the **Maps** panel which will open up, to switch to the **Maps** page.

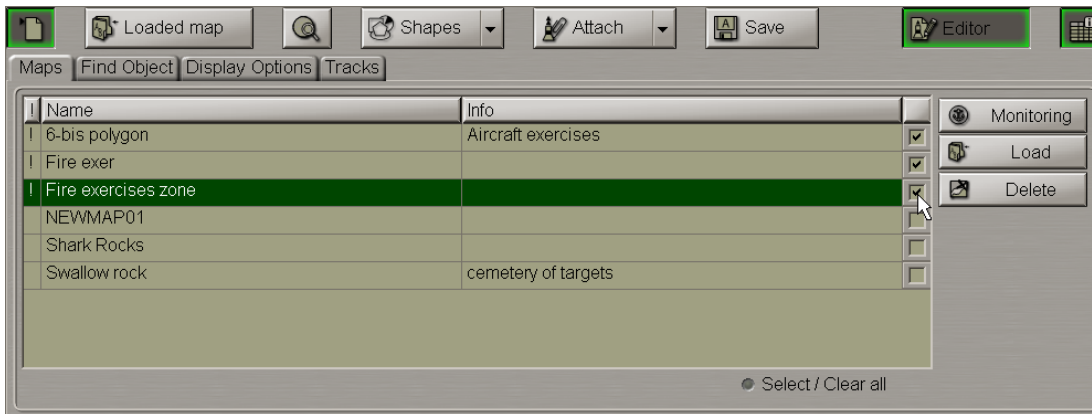

Check checkboxes in the right hand column of the table next to those maps which should be loaded in the editing mode. For maps selection you can also use the **Select/Clear all** checkbox.

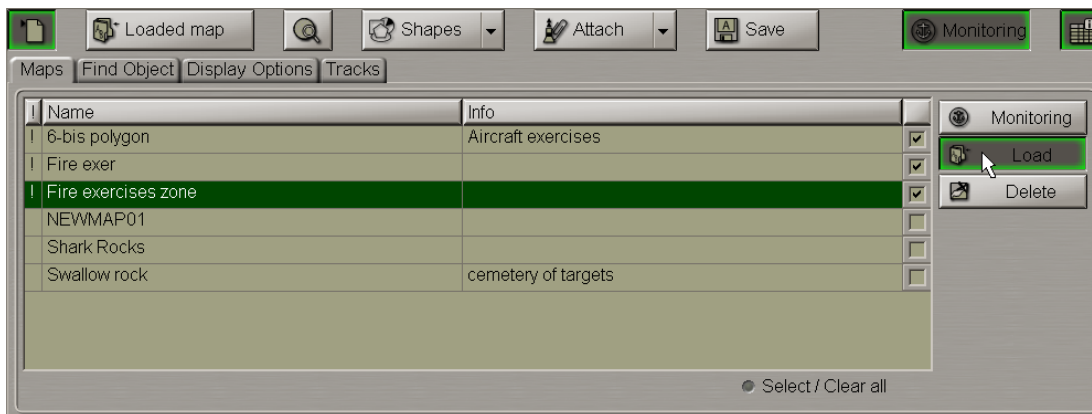

Press the **Load** button.

You can use an alternative method of loading maps in the editing mode via the context right button menu:

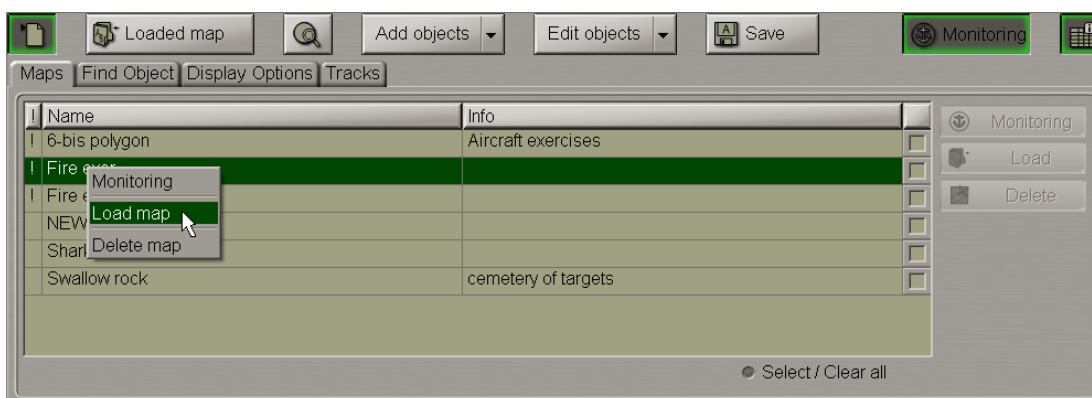

Names of maps from the table on the **Maps** page (all the available maps are displayed) will move to the list of maps available for editing.

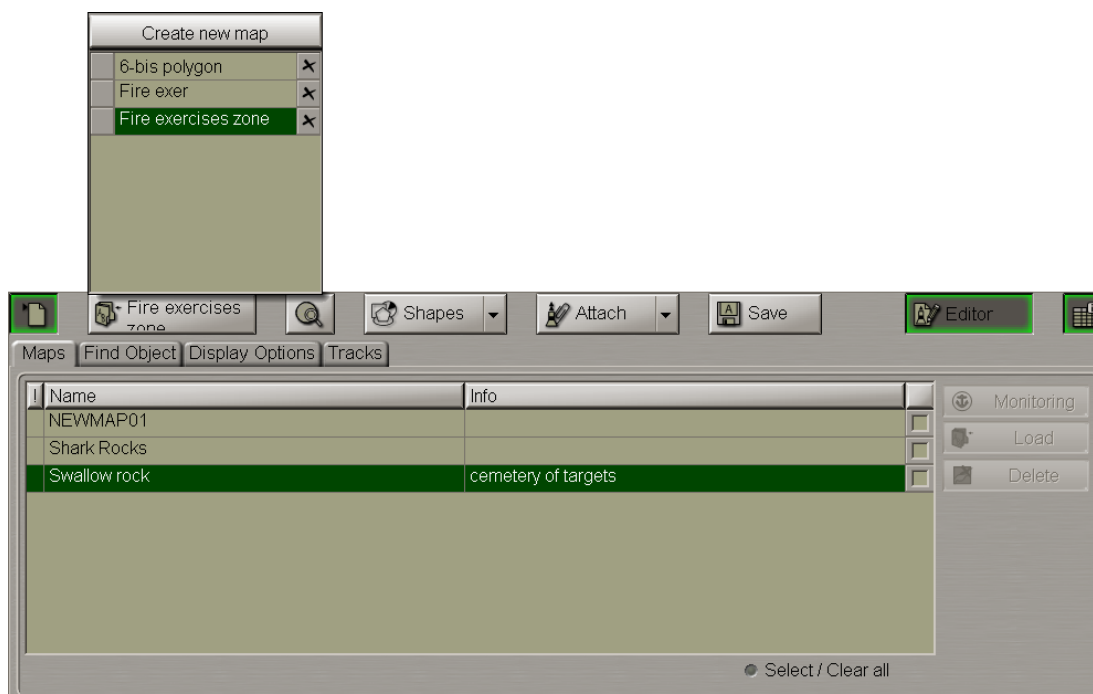

Press the button in the top left corner of the panel. The drop-down list displays all the maps available for editing. The button shows the name of the active map whose objects will be displayed in the table on the **Find Object** page (in the drop-down list, the name of this map is highlighted).

Press the  button to display the active map. The button in the top right corner will switch automatically to the **Editor** position.

For the objects from the loaded maps to be displayed on the on the ECDIS task screen, press the button in the top right corner of the panel.

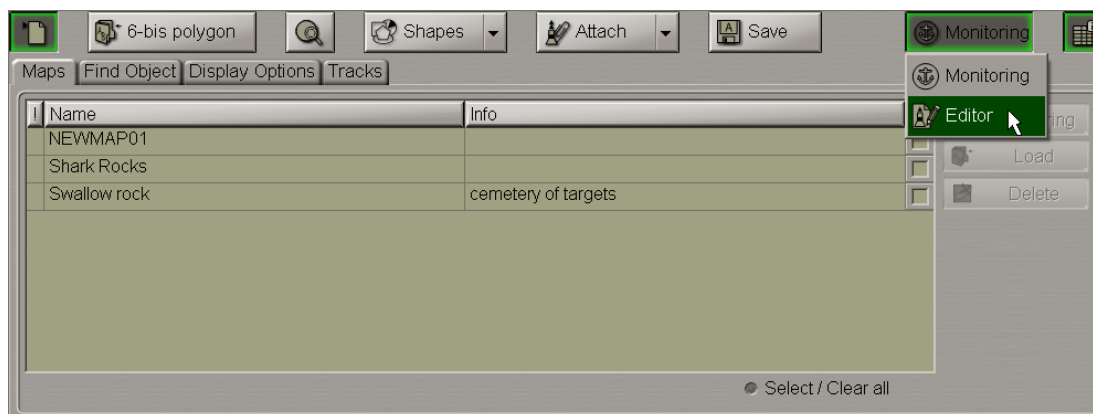

From the drop-down list select the **Editor** option.

To unload maps from the editing mode, press the button in the top left corner of the panel.

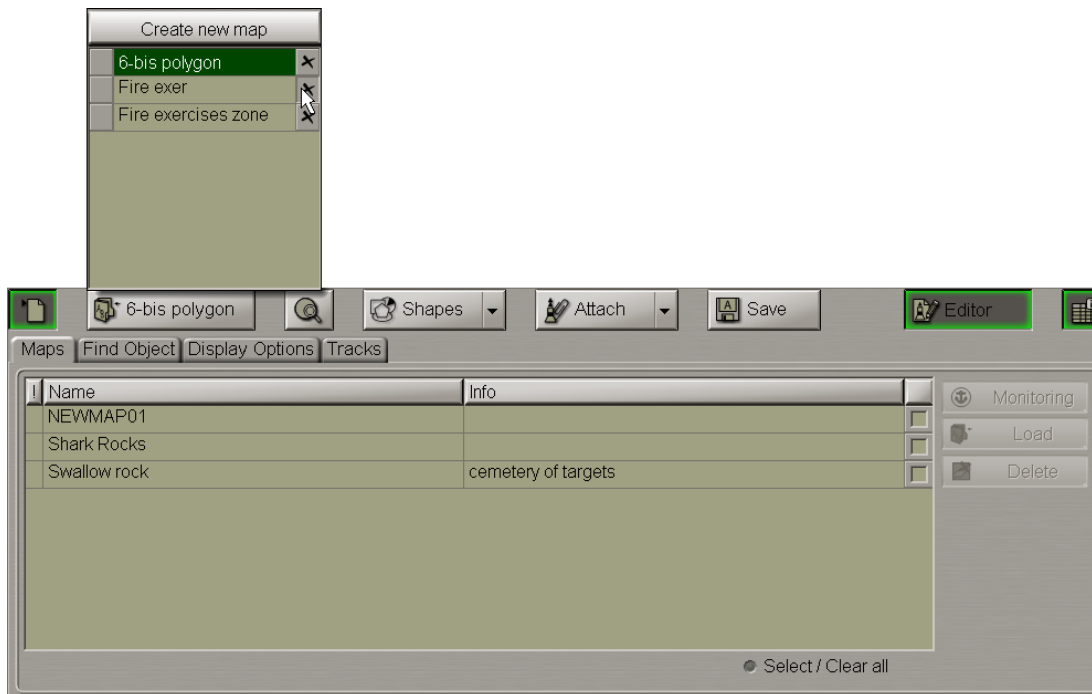

In the right hand column, next to the name of the map which should be unloaded, press the  button.

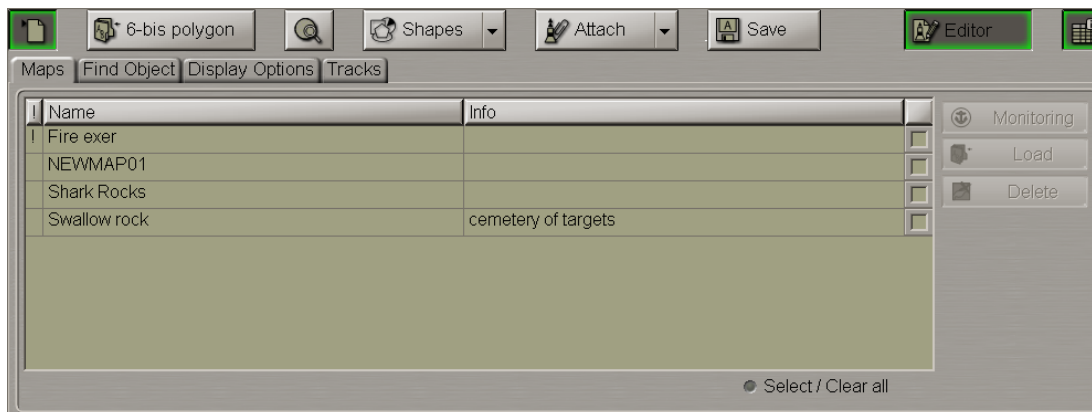

The map will be unloaded, and its name will move to the table of available maps on the **Maps** page.

Map Loading and Unloading for Monitoring

Attention! In this mode, maps are loaded exclusively for tracking map objects with the “Danger” attribute and targets in the assigned zones. Maps can be loaded/unloaded in/from the monitoring mode on the WS with the Navigational MASTER status only.

Open the **Maps** panel by selecting the appropriate line of the **Tasks List** menu in the tabs zone of the ECDIS task screen.

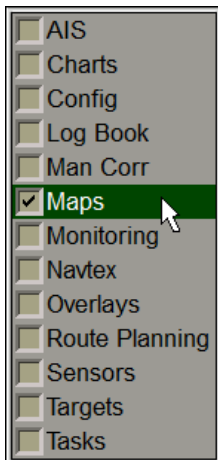

Use the tab in the top part of the **Maps** panel, which will open up, to switch to the **Maps** page.

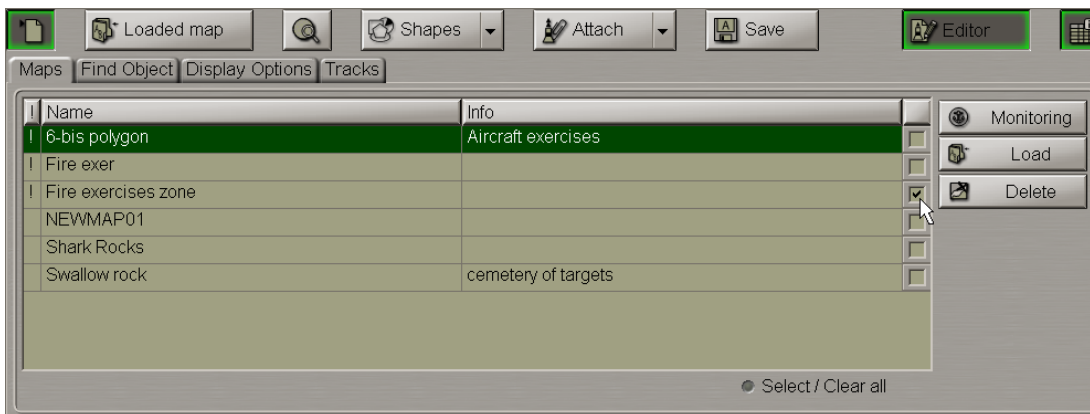

Check the checkboxes in the right hand column of the table next to those maps which should be loaded in the monitoring mode. For maps selection you can also use the **Select/Clear all** checkbox.

Note: Maps containing objects with the “Danger” attribute are marked with the “!” symbol in the table’s first column to the left of the map name.

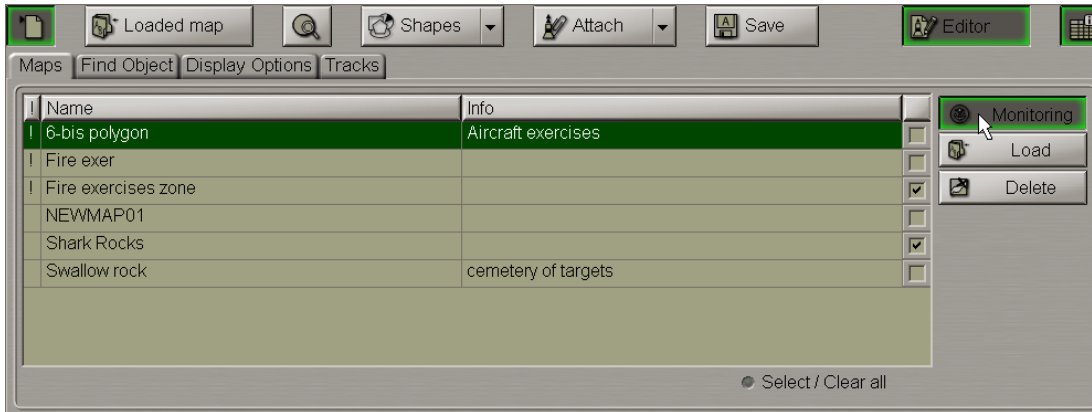

Press **Monitoring** button.

You can use an alternative method of loading maps in the monitoring mode via the context right button menu:

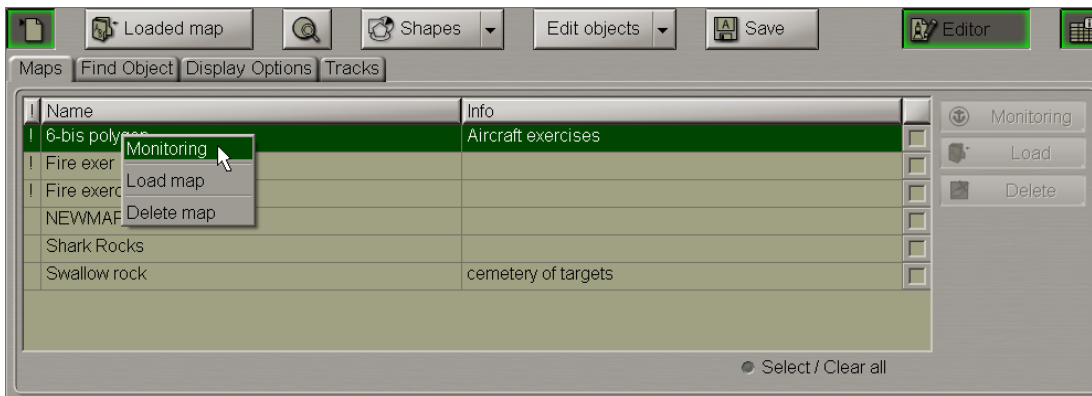

The marked maps will be loaded in the monitoring mode. This means that when these maps objects with the “Danger” attribute turn up within the safety frame, the **Navigational hazard** caution will be triggered off (see also document *Multi-Functional Display (v. 3.00.340). Functional Description, Chapter 4, section Main Alerts Generation Principles, paragraph Safety Alerts*).

At the same time, names of maps from the table on **Maps** page will move to the list of maps available for editing.

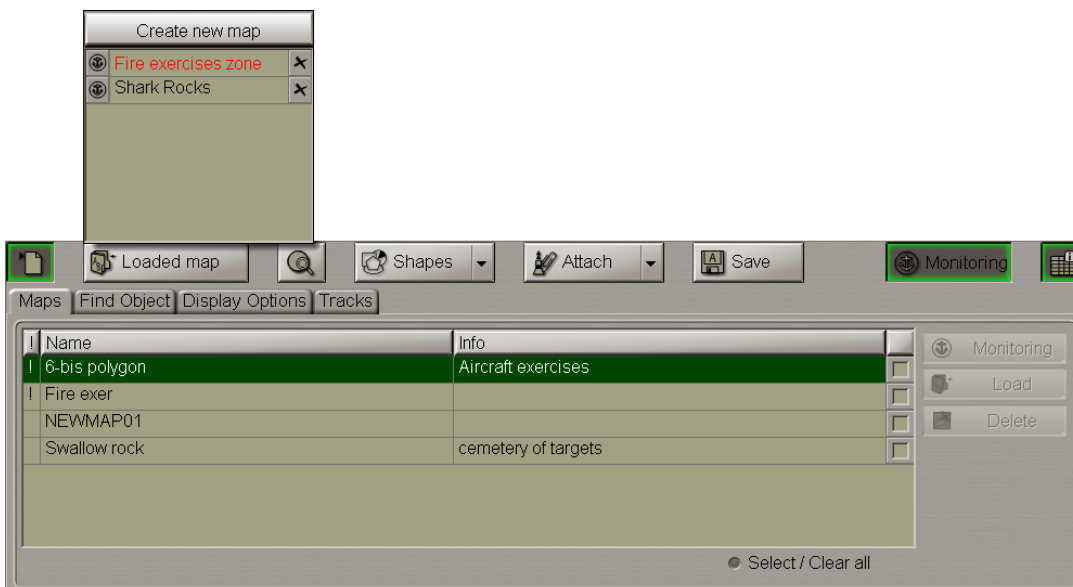

Press the button in the top left corner of the panel. In the drop-down list, maps loaded in the monitoring mode are marked with the  symbol to the left of the map name. Maps containing objects with the “Danger” attribute are shown in red.

As maps are loaded in the monitoring mode, their display on the ECDIS task screen is turned on automatically. The button in the top right corner of the panel switches to the **Monitoring** option.

Maps loaded in the monitoring mode are at the same time loaded in the editing mode as well. As this is done, it will be only objects of the saved maps which will be monitored. I.e., while the editing process is running/ no changes made before the map saving are taken into account.

To unload a map from the monitoring mode, press on the  sign to the left of the map name.

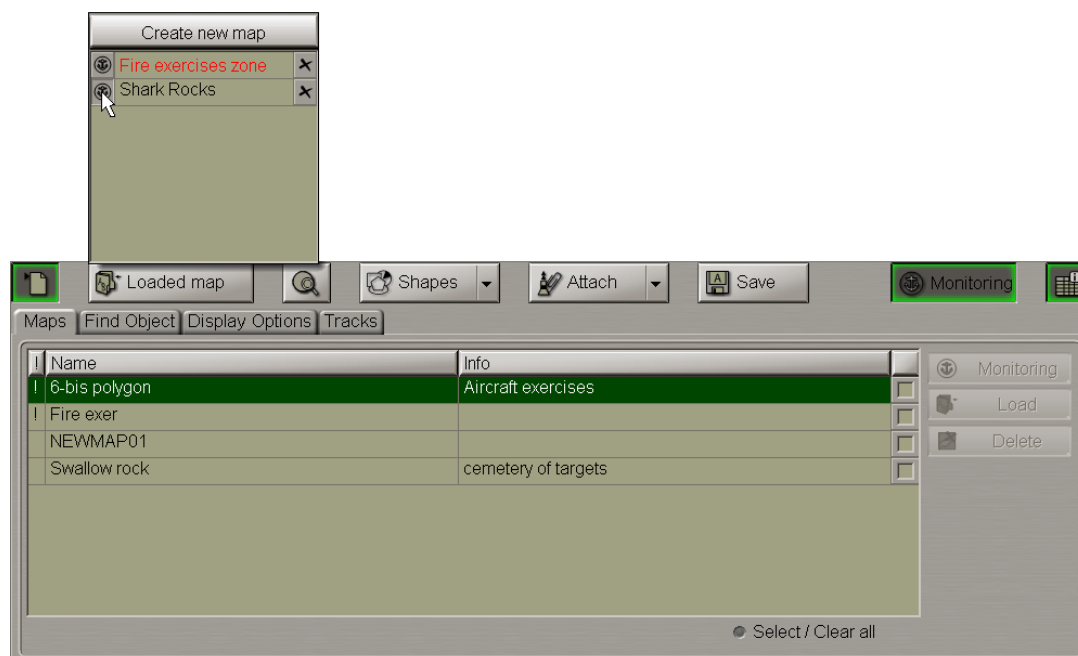

The map will be unloaded from the monitoring mode but will remain in the editing mode.

To unload a monitoring mode map from the editing mode, press the  button in the right hand column next to the name of the chart which should be unloaded.

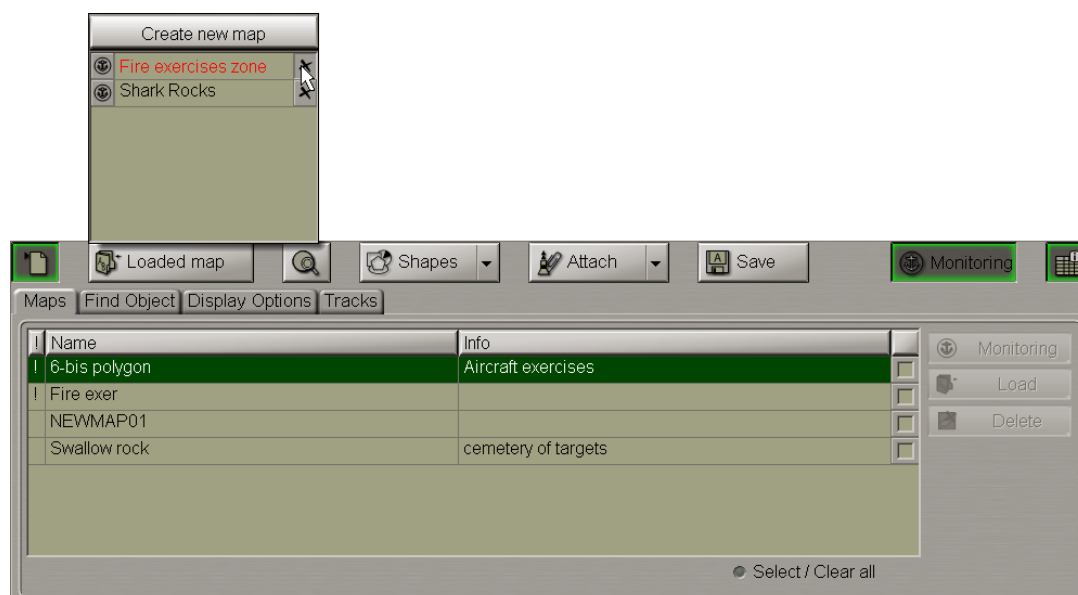

As this is done, a relevant warning is provided:

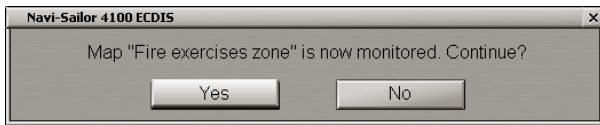

Press the **Yes** button.

Editing Map Objects



Attention! Symbol type objects cannot be displayed on scales smaller than 1:600,000.

Load the map containing the object you are going to edit (see section *Map Loading and Unloading for Editing* or section *Map Loading and Unloading for Monitoring*).

With several maps loaded simultaneously, for editing you can select any object out of those visible on the screen: the necessary chart will automatically become active.

Editing Map Object Attributes

Press the **Edit objects** button in the right-hand part of the panel.

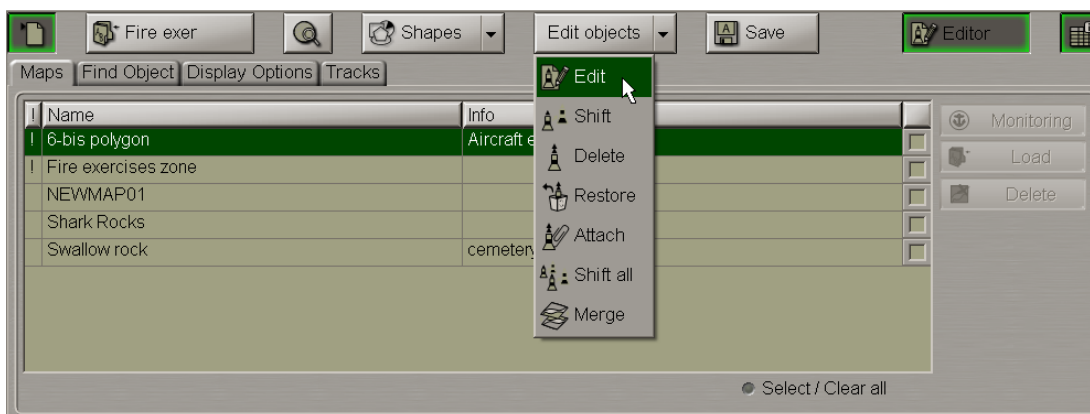

From the drop-down list select the **Edit** item.

Position the  acquisition marker which will appear, on the object (in case of text objects, the acquisition point is the first character) and press the left trackball button.



The bottom part of the screen will display a window for editing map objects.

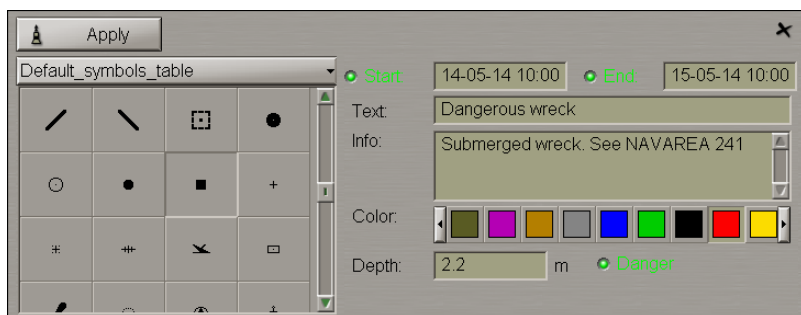



If necessary, edit the map object symbol, colour (the “Object colour” attribute), the map object display time (the “Temporary” attribute), map object text (the “Text” attribute), required information (the “Object information” attribute), the “Danger to navigation” attribute and the required depth value (the “Object depth” attribute) (see section *Creating and Saving Maps*, paragraph *Creating and Plotting Map Objects*, item *Plotting Symbol Type Objects*).

Press the **Apply** button in the editing window to confirm the changes you have made.

Attributes of the line, text, depth and shape type objects are edited in much the same way.

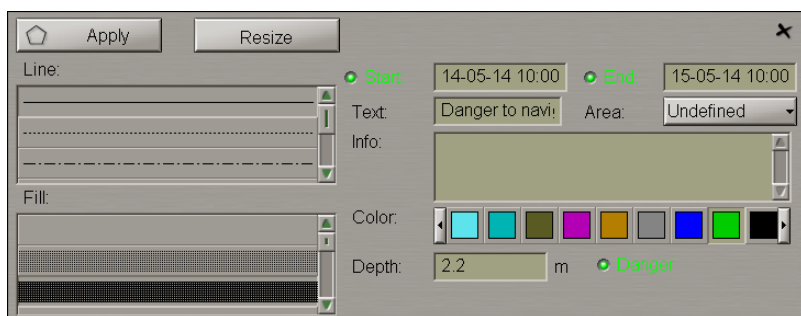
To resize line or shape type objects, select this object as described above and press the **Resize** button in edition window.



The  acquisition marker will appear on the first point of the selected line object.

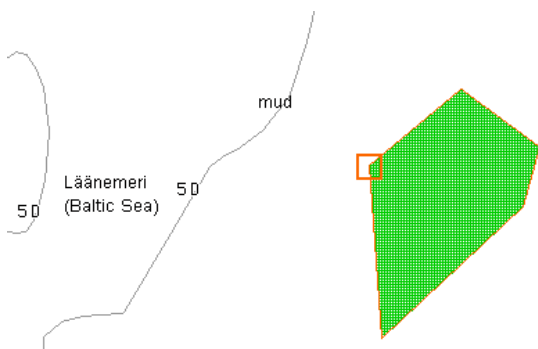

Use the acquisition marker to select a point on the line which should be changed, and press the left trackball button. The  graphic cursor will appear.

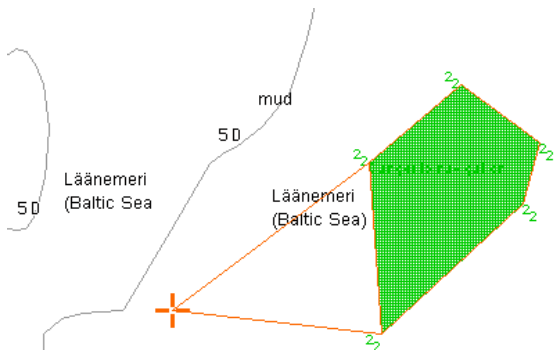

Move the cursor to the required coordinates. Press the left trackball button. The graphic cursor will change its form to acquisition marker. Repeat this operation for other map object boundaries until the necessary configuration is set.

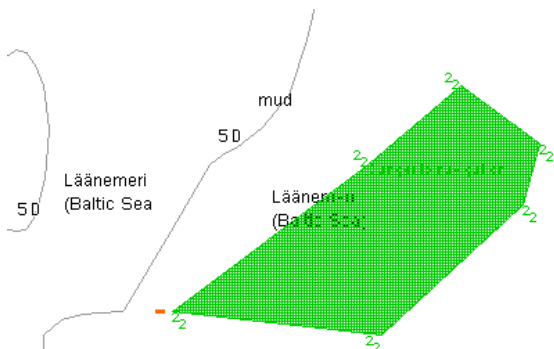

Press the right trackball button, all changes will be accepted.

Edit all the necessary map objects.

To exit from the editing mode press the right trackball button.

To attach/detach files to/from the map object, see section *Creating and Saving Maps*, paragraph *Creating and Plotting Map Objects*, item *Assigning "Attached File" Attribute*.

Editing Map Object Coordinates

Press the **Edit objects** button in the right-hand part of the panel.

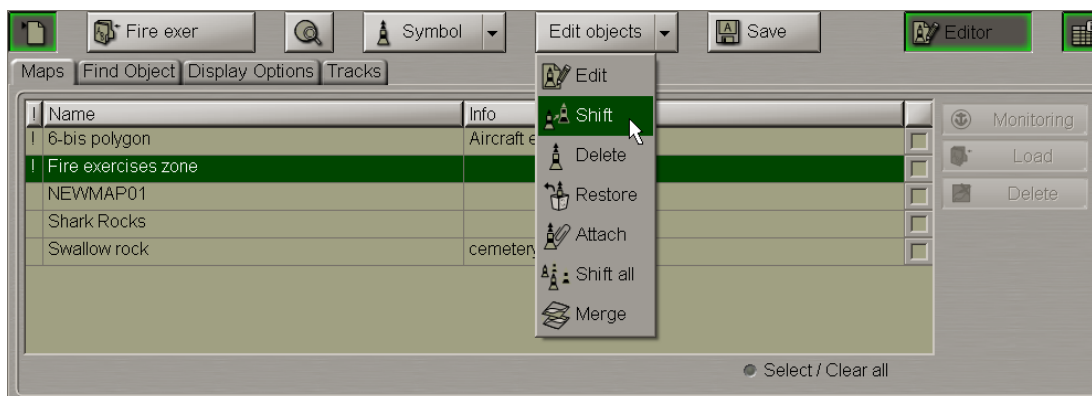

From the drop-down list select the **Shift** item.

Position the  acquisition marker which will appear, on the object to be shifted (the first character of a text object or a point in a line or area type object).



Press the left trackball button. Position the marker which will appear, in the new object coordinates within the displayed Chart panel.

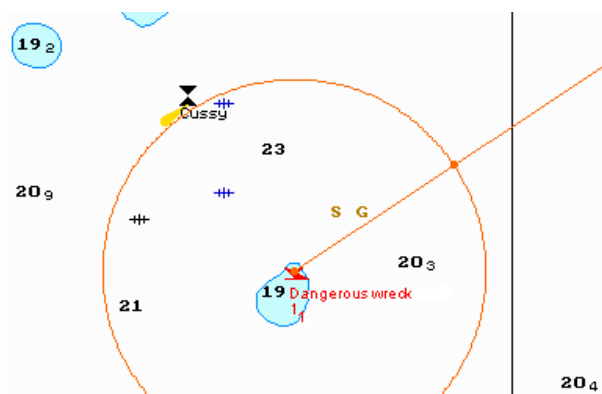

Press the left trackball button: the object will move to the specified coordinates.

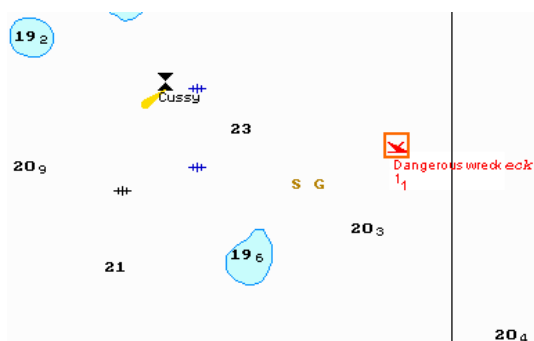

Press the right trackball button to exit from the mode of editing of the map object coordinates.

You can use a similar procedure to change coordinates of all the map objects by selecting the **Shift All** item from the drop-down list (to do this, it is necessary to enter the password).



Attention! In this case, all the map objects of the layer will be shifted to the same distance and in the same direction as the object which is being edited.

Deleting Map Object

Press the **Edit objects** button in the right-hand part of the panel.

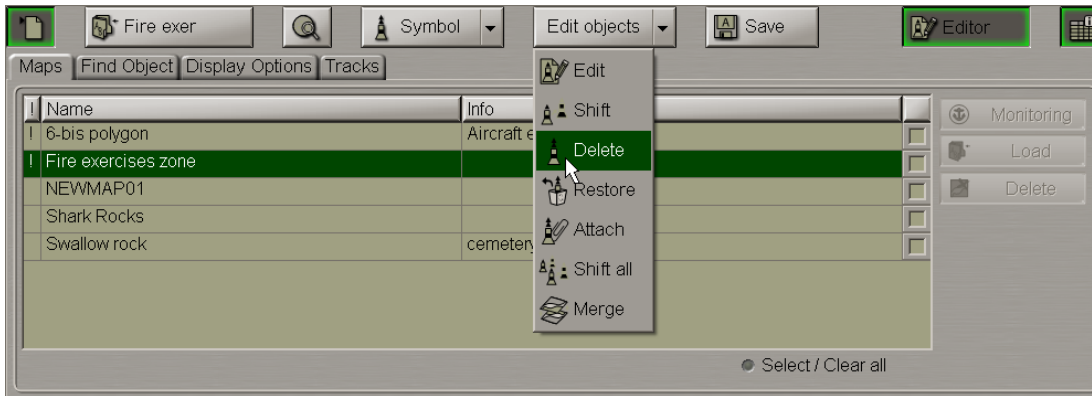

From the drop-down list select the **Delete** item.

Position the  acquisition marker which will appear, on the object to be deleted (the first character of a text object or a point in a line or area type object).

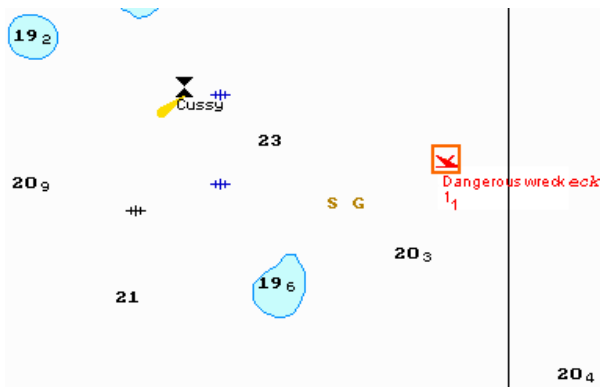

Press the left trackball button: the presentation of the object will be removed from the Chart panel.



Press the right trackball button to exit from the map object deleting mode.

Restoring Deleted Map Object

Switch to the **Display Options** page.

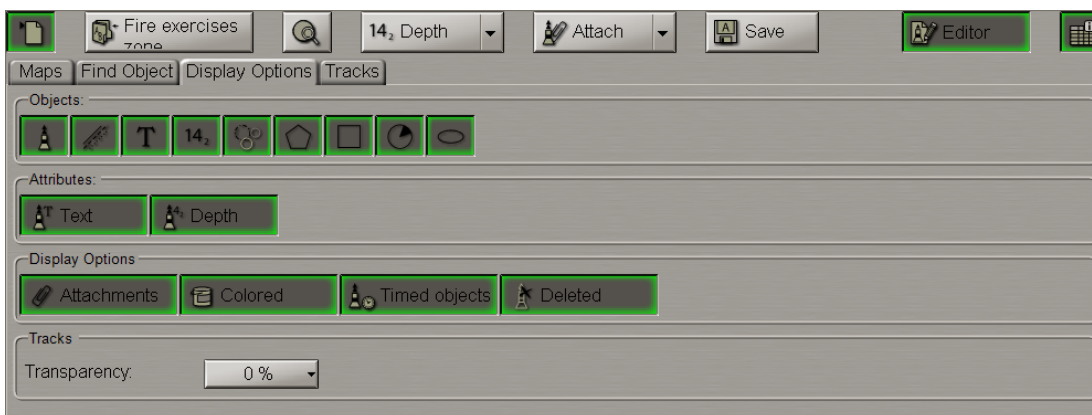

Press the **Deleted** button in the **Display Options** group. The screen will display all the previously deleted objects shown in the grey colour.



Press the **Edit objects** button in the right-hand part of the panel.

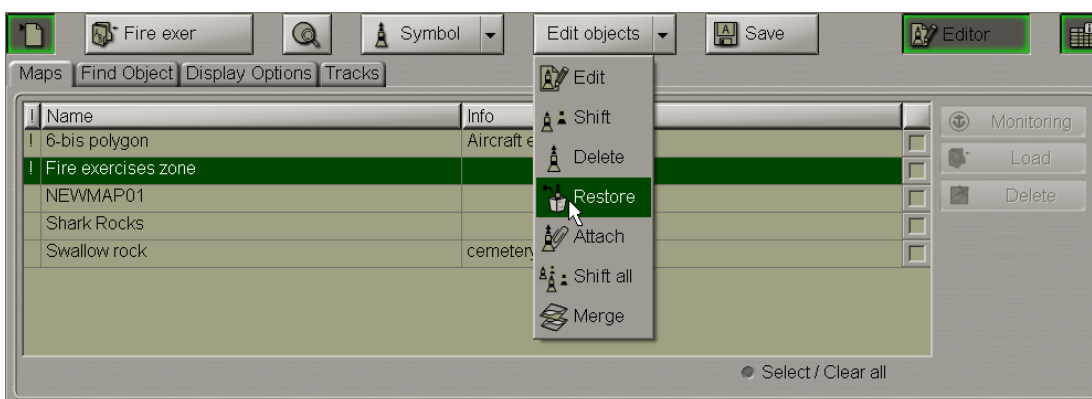

From the drop-down list select **Restore** item.

Position the acquisition marker , which will appear, on the deleted object (the first character of a text object or a corner point of a line or area type object).



Press the left trackball button: the “Deleted object” attribute is removed, and the object is highlighted in accordance with the previously made settings.



Press the right trackball button to exit from the deleted map object restore mode.

Merging Maps

Open the **Maps** panel by selecting the appropriate line of the **Tasks List** menu in the tabs zone of the ECDIS task screen.

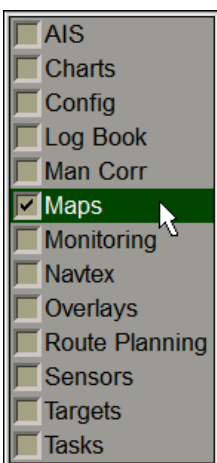

Use the tab in the top part of the **Maps** panel which will open up, to switch to the **Maps** page.

Load the map containing the object you are going to merge (see section *Map Loading and Unloading for Editing*).

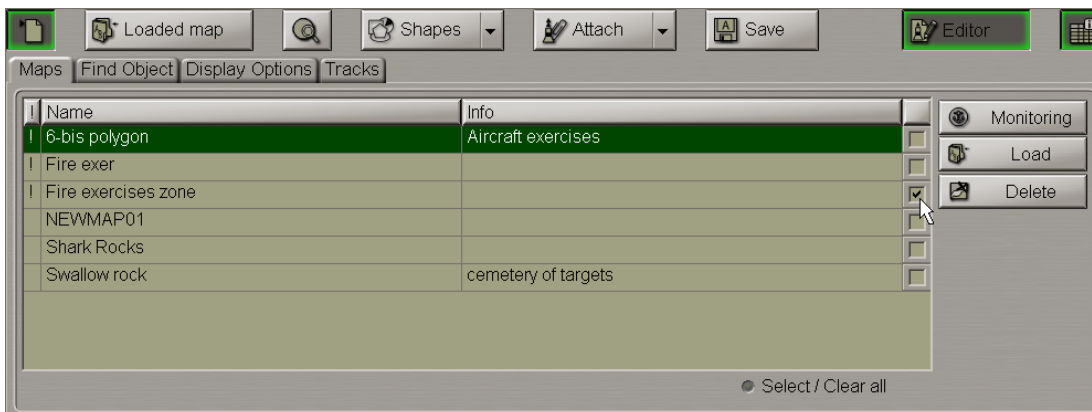

The merging of maps implies that a newly created map will contain map objects from all the merged maps:

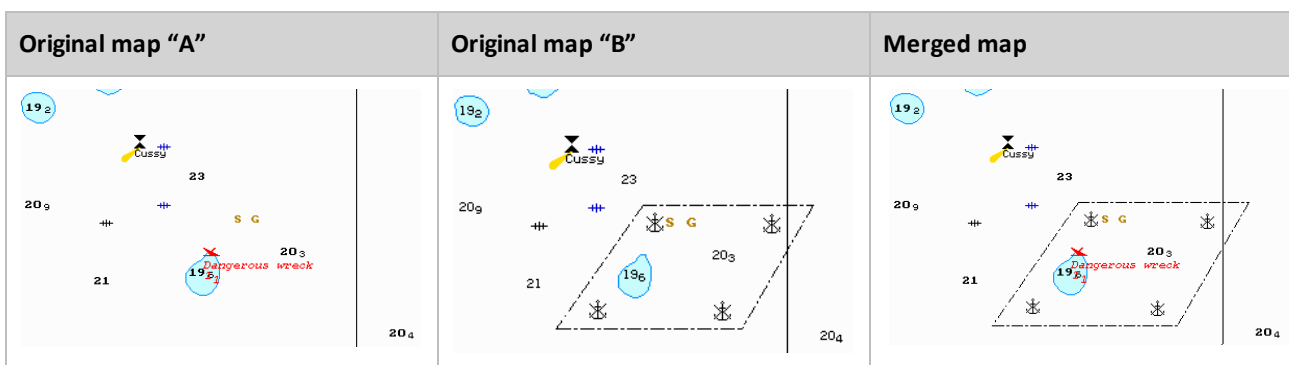

Press the **Edit objects** button in the right-hand part of the panel.

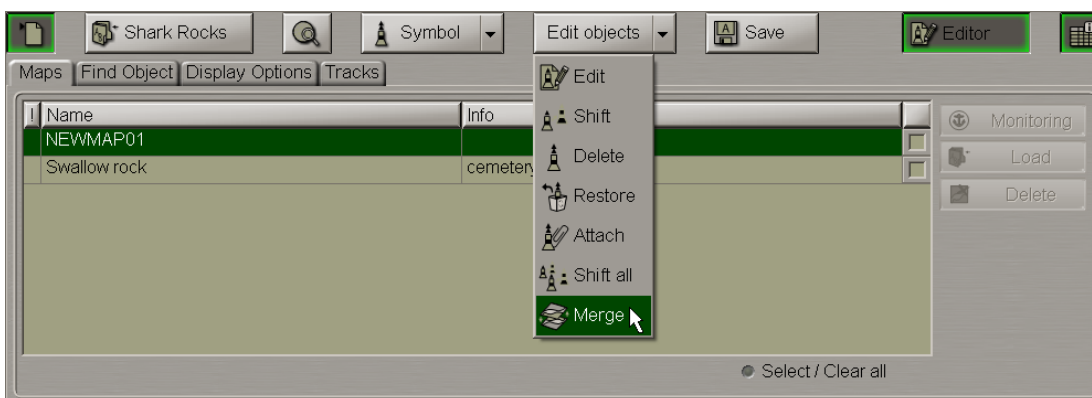

From the drop-down list select the **Merge** item.

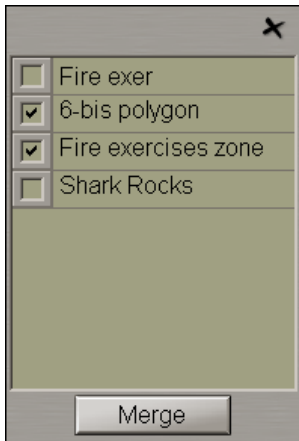

In the window which will open up, check the checkboxes next to the maps which should be merged.
Press the **Merge** button.

If 2 maps are selected for merging, the **Merge** window which will open up will have the following form:

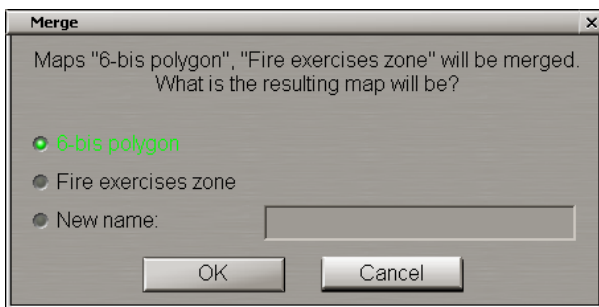

Select the name under which the merged map will be saved (under one of the source map names, or under a new name).

If more than two maps are selected for merging, the **Merge** window which will open up has the following form:

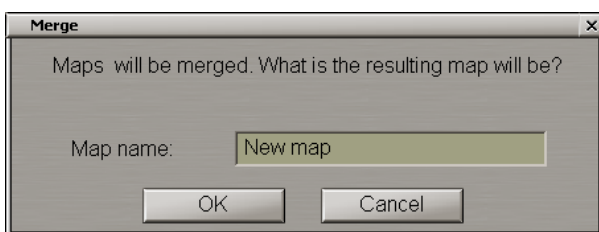

Enter the new map name.

Press the **OK** button.

Deleting Maps

Open the Maps panel by selecting the appropriate line of the **Tasks List** menu in the tabs zone of the ECDIS task screen.

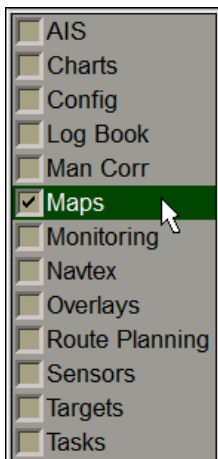

Use the tab in the top part of the **Maps** panel which will open up, to switch to the **Maps** page.

Check the checkboxes in the right hand column of the table next to the maps which should be deleted. For maps selection you can also use the **Select/Clear all** checkbox.

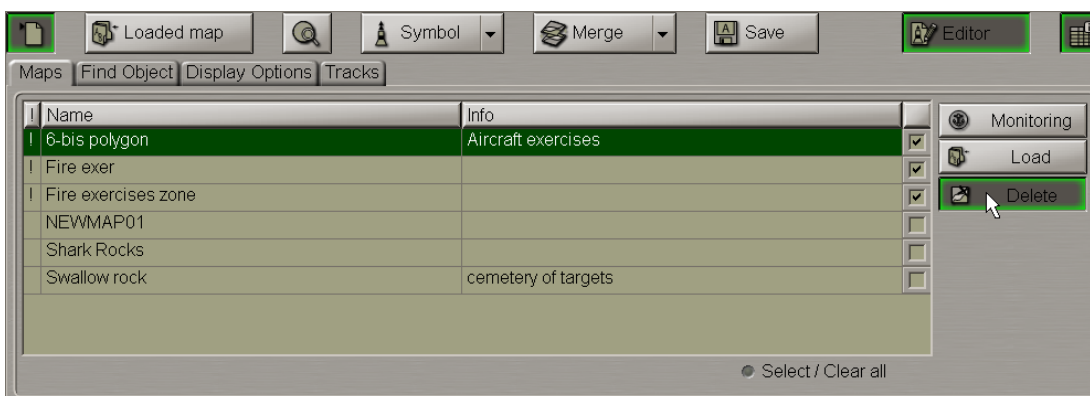

Press the **Delete** button.

You can use an alternative map deleting method by using the context right button menu:

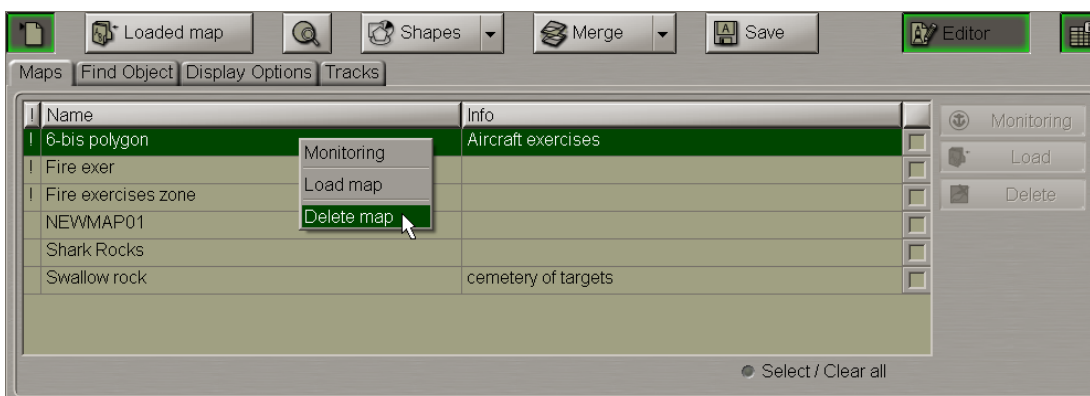

In the window which will appear, press the **OK** button to confirm the deleting of the maps:

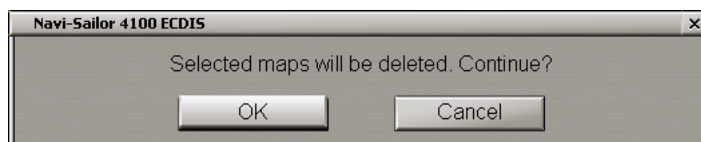

The selected maps will be deleted.

Search for Map Objects



Attention! Symbol type objects cannot be displayed on scales smaller than 1:600,000.

Open the **Maps** panel by selecting the appropriate line of the **Tasks List** menu in the tabs zone of the ECDIS task screen.

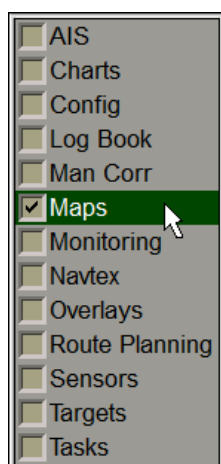

Load the map containing the object you are going to search for and select this map as active (see section *Map Loading and Unloading for Editing*).

Switch to the **Find object** page.

Select the required map object in the left-hand part of the page and press the left trackball button. Coordinates of the selected object will be displayed in the right-hand part of the page.

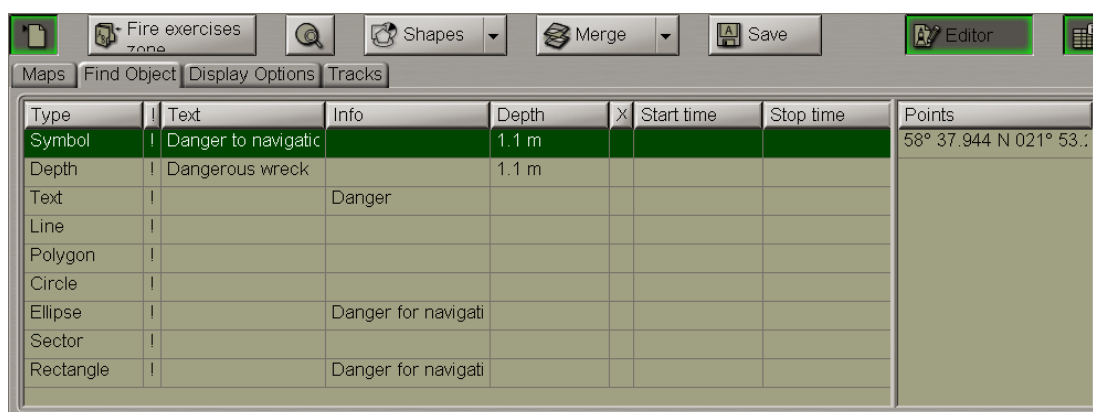

A double click of the left trackball button on the selected object line or its coordinates displays this object in the centre of the Chart panel highlighted with a flashing circle for 10 seconds.

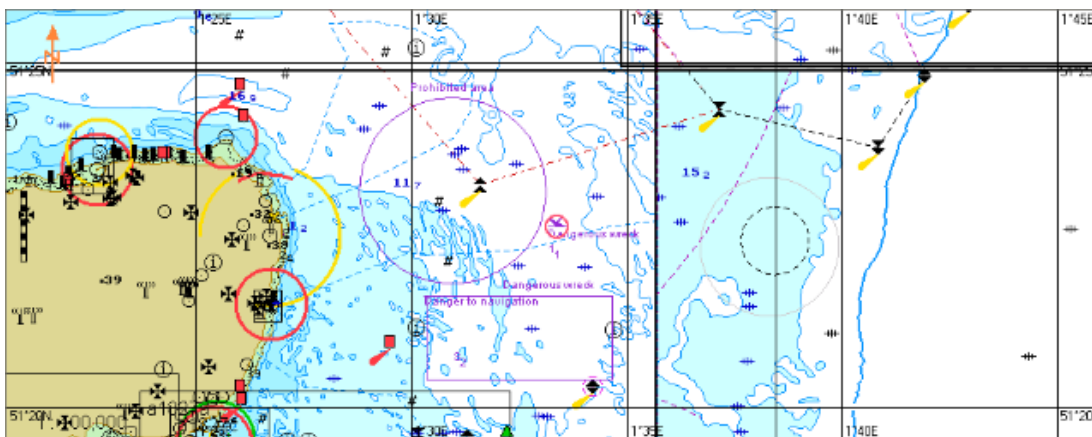

With the selection of line or area type objects, the right-hand part of the page displays coordinates of all the points which the line/area type object consists of.

Type	Text	Info	Depth	X	Start time	Stop time	Points
Symbol	Danger to navigatic		1.1 m				58° 36.597 N 021° 53.7
Depth	Dangerous wreck		1.1 m				58° 37.549 N 021° 51.7
Text		Danger					58° 36.704 N 021° 51.7
Line							58° 36.502 N 021° 53.7
Polygon							
Circle							
Ellipse		Danger for navigati					
Sector							
Rectangle		Danger for navigati					

A double click of the left trackball button on the coordinates of any point which the line/area type object consists of, displays this point in the centre of the Chart panel highlighted with a flashing circle for 10 seconds.

Map Handling in Network Configuration

In the case of network configuration map handling varies on stations with different navigation status.

Maps can be loaded in the editing mode independently on different WS's with both, the MASTER and SLAVE status. Maps are not synchronized with other WS's until you save them on your WS by using the Save button. After the synchronizing, saving is done resulting in that identical maps will be stored in all the WS's included in the network. If at the saving moment some of the WS's were turned off or disconnected from the network. Synchronizing will occur as they are turned on or join the network.

If a map with one and the same name is edited simultaneously on different WS's (e.g., on WS1, WS2 and WS4), after the Save button is pressed on any of these WS's (e.g., WS1), the map will be saved on this WS and on all the WS's of the network on which no its editing was done (e.g., all the WS's except WS 2 and WS4).

After an attempt to save maps on the WS's on which the map was edited (e.g., WS 2 or WS4), the following warning will be displayed:

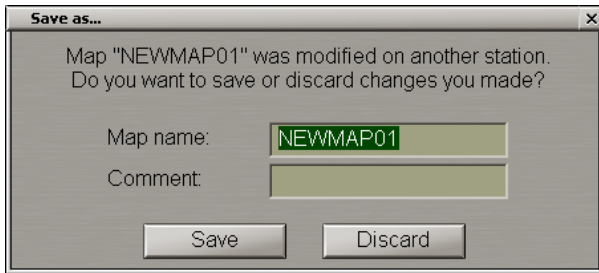

If the Ignore button is pressed, all the changes made on this WS (e.g., WS2) will be ignored, and the map will be synchronized with the rest of WS's (e.g., except for WS4).

When the Save button is pressed, the map is saved on the WS (e.g., WS2) with all the changes and is synchronized with the rest of WS's (e.g., except for WS 4).

Note: If a map is saved under another name, it is synchronized immediately on all the WS's.

Such algorithm is in action until the chart is saved on the rest of WS's (e.g., WS 4) where it was edited.



Attention! Maps can be loaded (unloaded) in the monitoring mode on the WS's with the MASTER status only.

If an attempt is made to unload such map from the editing mode on a WS with the SLAVE status, the following warning will be provided:

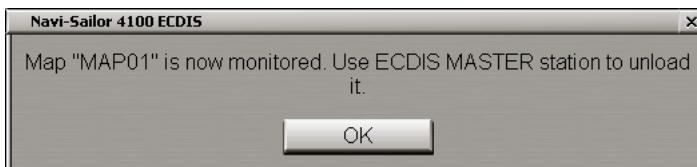

And you will only be able to carry out such operation on the WS with the MASTER status.

Chapter 9.

Handling of Routes

This chapter describes the procedure used in the handling of routes and schedules.

<u>Work with Route</u>	278
Default Route Settings	278
Creating a Route	279
Route Loading and Unloading	286
Fast Route Search	287
Anchoring Operations	288
Editing the Route	295
Deleting a Route	303
Checking and Editing the Route Taking into Account Dangers to Navigation	304
Route Approval and Protection	308
Routes Exchange with SPOS	311
<u>Work with Schedule</u>	313
Drawing a Schedule	313
Editing a Schedule	316
Deleting a Schedule	317
<u>Voyage Plan Creation</u>	317
Data Collection	317
Obtaining Information on Sun/Moon on the Route	319
Voyage Plan Data Edition	320
Voyage Plan Print Preview and Printing	324
Exporting Voyage Plan	326

Work with Route

Default Route Settings

Open **Config** panel by selecting the appropriate line of **Tasks List** menu in the tabs zone of the ECDIS task screen.

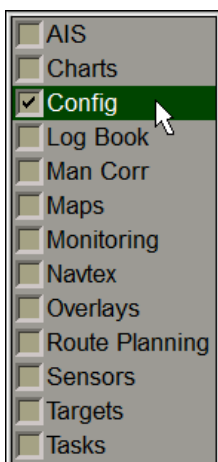

Use the tab in the top part of **Config** panel, which will open up, to switch to **Route Settings** page.

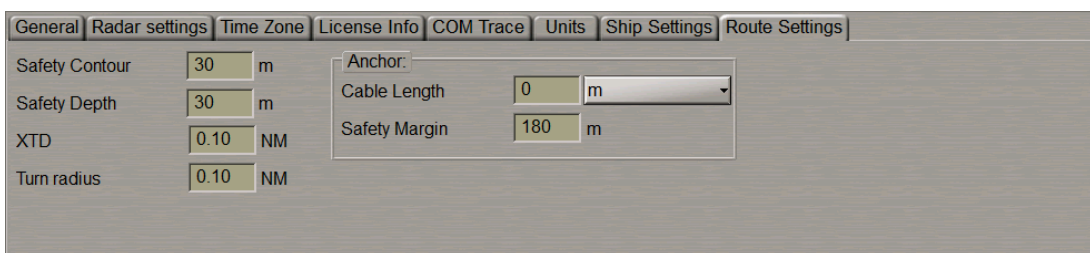

This page is intended for setting the default values of route elements. Set the following values which will be used during the route plotting on the **Route Planning**:

- **Safety Contour** - safety contour value for the route legs;
- **Safety Depth** - safety depth value for the route legs;
- **XTD** - cross track distance values (simultaneously for the port and starboard sides) for the route legs;
- **Turn radius** - turn radius value for a WPT.

These values for route elements can subsequently be changed in the course of route editing on the **Route Planning** panel (see below the *Entering Additional Data* item).

In the **Anchor** group, use the **Cable Length** and **Safety Margin** input fields to set the default values for respective parameters that will be used for the anchoring operations (see below the *Anchoring Operations* paragraph).

Creating a Route

Open **Route Planning** panel by selecting the appropriate line of **Tasks List** menu in the tabs zone of the ECDIS task screen.

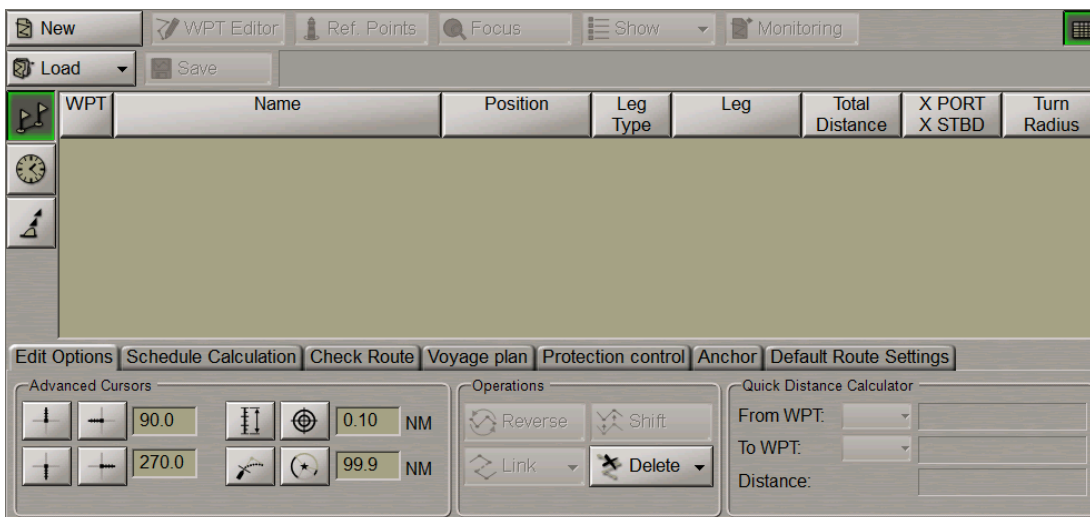
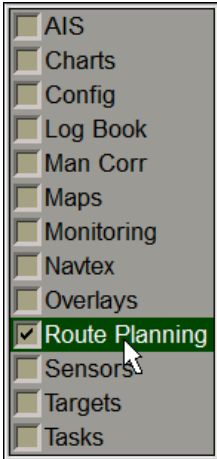

Selecting Cursor Form

Switch to **Edit Options** page.

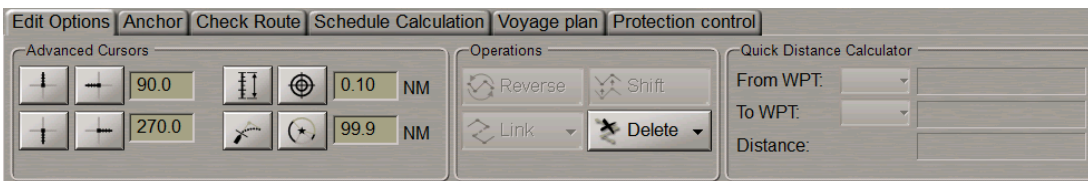

The graphics cursor is used during the operation of some functions and represents an intersection of lines corresponding to the latitude and longitude of the given point, but the form of the graphics cursor can be changed as required.

By default, the Standard cursor mode is set. To turn on additional graphic cursor tools, press the appropriate buttons of the **Advanced Cursors** group:

- To display the line (Heading Mark) ahead of the cursor position in the direction of the plotted route leg;
- To display a line opposite to the Heading Mark from a waypoint;
- To display two additional lines setting their angles relative to Heading Mark line;
- To display range marks on the cursor lines in the form of notches or concentric circles, set the distance between them in the box to the right.

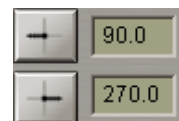

Note: For the notches to be displayed, at least one advanced cursor display button should be enabled (i.e., ) . This is not required for the display of circles.

- To plot waypoints taking into account the WOL and F dist;
- To plot waypoints taking into account the lighthouse visibility range which is set in the box to the right.



The advanced capabilities of the graphic cursor prove to be useful in, e.g. planning a route along the lead lines.

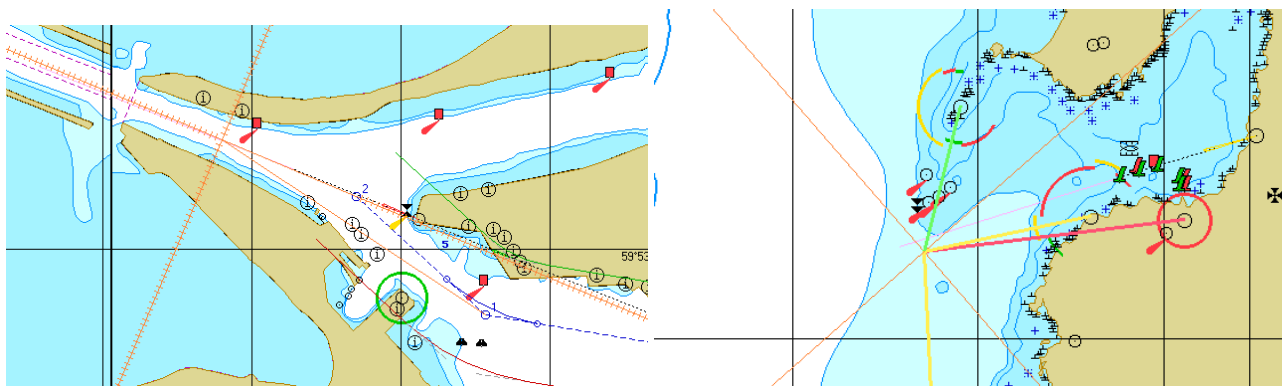

Plotting Route

Press **New** button in the top left part of the panel to display a blank table for the generation of a new route.

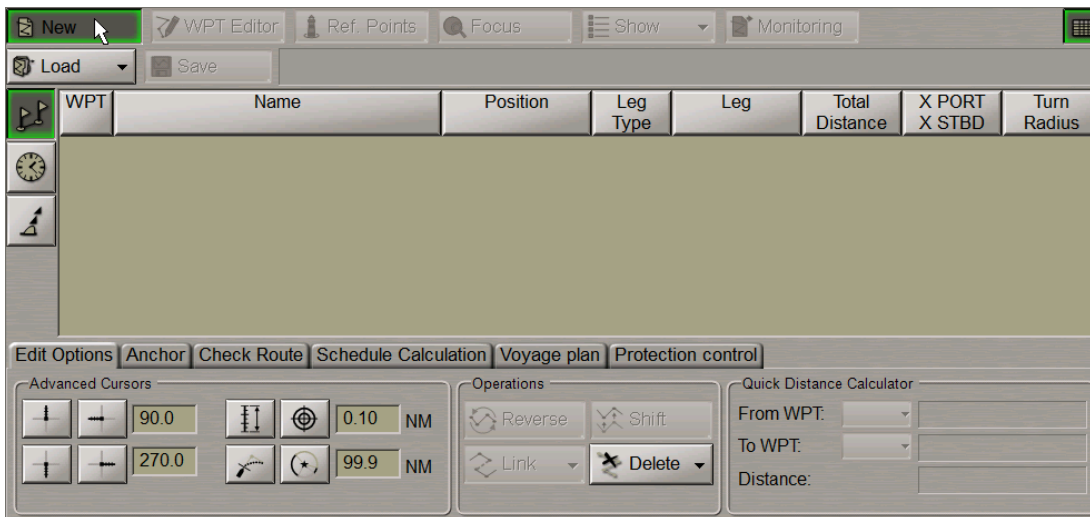

Graphic cursor will appear on the Chart Panel, whereas the right bottom part of the screen will display **Place First Point** information window.

Place first point	
Latitude	58°09.781' N
Longitude	011°53.543' W
Anc. Brg	000.0 °
Anc. Rng	0.00 NM
Ship position	
	true relative
Bearing	272.3 020.8
Opp. Bearing	092.3 159.2
Range	757.85 NM
Press Tab to edit manually	

Set the cursor in the start point coordinates by moving the trackball/mouse, using the data in **Place First Point** window, and press the left trackball/mouse button.

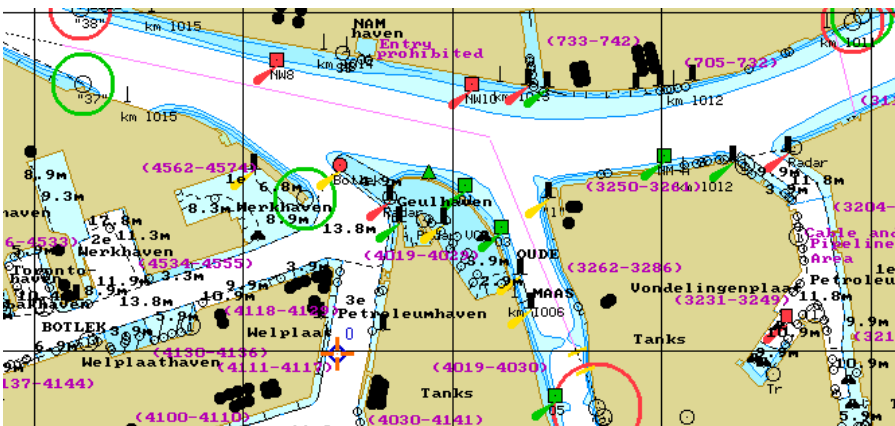

The symbol of the start point with its number ("0") will appear on the Chart Panel. Position the cursor in the coordinates of the next point. At this stage, a route leg line will be drawn between the cursor and the start point. Press the left trackball/mouse button: the Chart Panel will display the next point symbol with "1" for number and the plotted route leg. By default, XTD lines are also shown. To turn off their display, use **Display** button (see below).

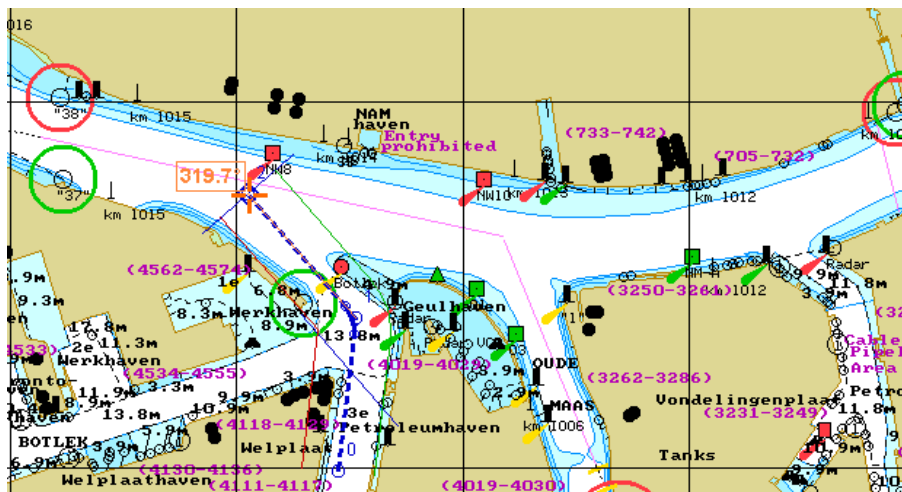

If it is necessary to set several waypoints, repeat the mouse moving and left button pressing operation as many times as there are WPT's required to be set.

If the cursor is positioned beyond the Chart Panel boundaries, it will be re-drawn automatically so that there is always a chart from the chart folio under the cursor.

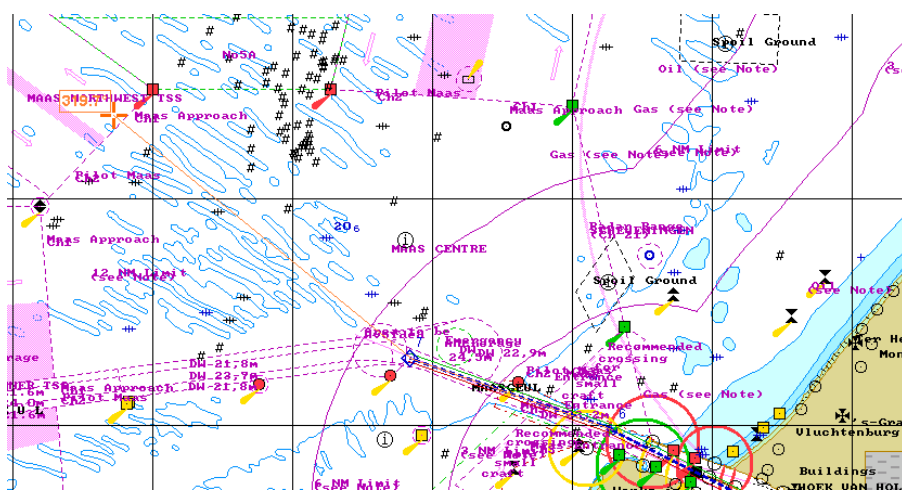

After the setting of the last point of the planned route, double click the right trackball/mouse button: the cursor will exit from the route planning and editing mode and will assume the form of the free cursor.

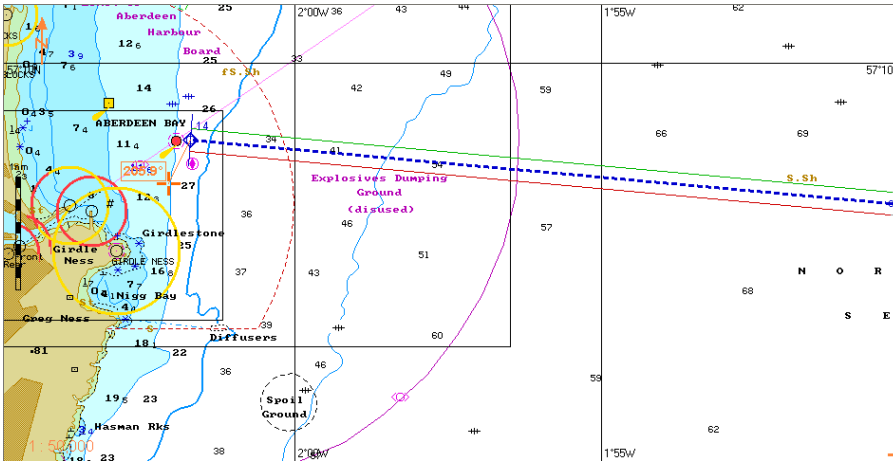

The generation of the route is completed.

Entering Additional Data

The display of the table is turned on/off by using the Show tables button.



In the left part of the **Route Planning** panel, press the button to display the corresponding table.



WPT	Name	Position	Leg Type	Leg	Total Distance	X PORT X STBD	Turn Radius
0		51° 53.659 N 004° 18.420 E	XX	XXX.X XXX.X	XXX.X	XXX.X XXX.X	XXX.X
1		51° 54.865 N 004° 14.838 E	RL	298.6° 2.27 NM	2.27 NM	0.10 NM 0.10 NM	0.50 NM
2		51° 56.571 N 004° 11.176 E	RL	307.0° 2.84 NM	5.11 NM	0.10 NM 0.10 NM	0.50 NM
3		51° 59.480 N 004° 02.548 E	RL	298.6° 6.09 NM	11.21 NM	0.10 NM 0.10 NM	0.50 NM

Advanced Cursors: 90.0, 270.0, 0.10 NM, 99.9 NM

Operations: Reverse, Shift, Link, Delete

Quick Distance Calculator: From WPT: 0, To WPT: 15, Distance: 398.35 NM

Waypoints table consists of the following data (by columns):

- **WPT** – WPT number;
- **Name** – WPT name;
- **Position** – WPT latitude and longitude coordinate;
- **Leg Type** – route leg type (RL or GC) from the previous to the current WPT, set by the operator; all route leg calculations are referred to the WGS-84 reference datum;
- **Leg** – course and distance from the previous to the current WPT;
- **Total Distance** – summary distance between the initial (0) and current WPT by the route legs;
- **X PORT/X STBD** – safe zone to the left and to the right of the route leg;
- **Turn Radius**– operator-set radius of the arc for the display of an approximate ship track on the turn.

For input of the additional data, perform the procedures detailed below:

- position the cursor on **Name** element cell; double click the left trackball/mouse button to activate the cell;



- enter the WPT name; press <Enter> key;

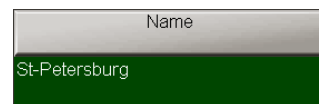

- position the cursor on **Leg Type** element cell; double click the left trackball/mouse button to activate the cell;

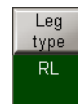

- press the button in the right-hand part of the cell and select the sailing type from the list which will open up;



- press the left trackball/mouse button to confirm the changes you have made;



- position the cursor on **X PORT/X STBD** element cell; double click the left trackball/mouse button to activate the cell;

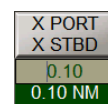

- edit XTD value to the left of the route leg; press the left trackball/mouse button;

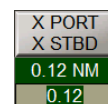

- edit XTD value to the right of the route leg; press the left trackball/mouse button;

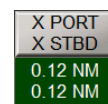

- position the cursor on **Turn Radius** element cell; double click the left trackball/mouse button to activate the cell;

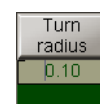

- enter the radius for the arc of the suitable ship track on the turning circle; press the left trackball/mouse button.

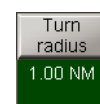

When filling in the table you can use the context menu called by the right trackball/mouse button:



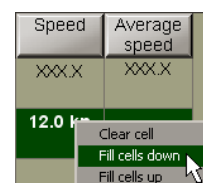

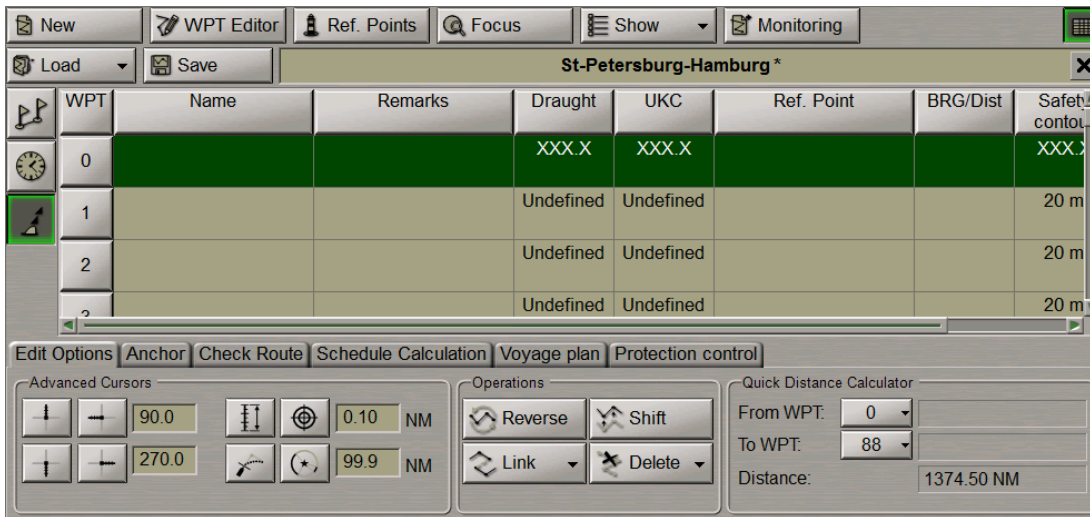

- **Clear cell** – to delete a value in the selected cell;
- **Fill cells down** – to fill in all the cells below with a value entered in the selected cell;
- **Fill cells up** – to fill in all the cells above with a value entered in the selected cell.

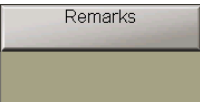

In the left part of the **Route Planning** panel, press the **Extra Data** button to display the corresponding table.

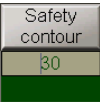

For input of the additional route data, perform the procedures detailed below:

- position the cursor on **Remarks** element cell; double click the left trackball/mouse button to activate the cell;
 
- enter the remark; press <Enter> key;
 
- position the cursor on **Safety contour** element cell; double click the left trackball/mouse button to activate the cell;
 
- edit safety contour value to the current route leg; press the left trackball/mouse button (by default, and also for all the routes created in the earlier versions, the 30 m value is set);
 
- position the cursor on **Safety depth** element cell; double click the left trackball/mouse button to activate the cell;
 
- edit safety depth value to the current route leg; press the left trackball/mouse button (by default, and also for all the routes created in the earlier versions, the 30 m value is set).
 

When filling in the table you can use the context menu called by the right trackball/mouse button:

- **Clear cell** – to delete a value in the selected cell;
- **Fill cells down** – to fill in all the cells below with a value entered in the selected cell;
- **Fill cells up** – to fill in all the cells above with a value entered in the selected cell.

Press **Show** button in the top part of the panel.

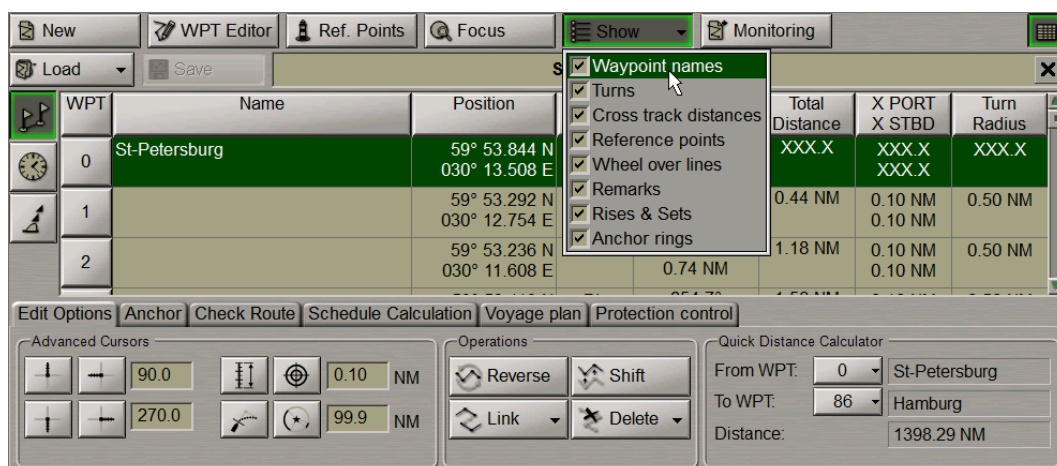

The following checkboxes in drop-down list for turning on the display of route options on the ECDIS task screen are checked by default:

- **Waypoints names** – to display on the electronic chart WPT names;
- **Turns** – to display on the electronic chart the turn radius arc for the active route;
- **Cross track distances** – to display on the electronic chart safety lines for the active route;
- **Reference points** – to display Reference points;
- **Wheel over lines** – to display on the electronic chart WOL marks;
- **Remarks** – to display remarks;
- **Rises & Sets** - to display sun and moon rises and sets symbols;
- **Anchor rings** - to display anchor rings.

If necessary, uncheck **Waypoints names** checkbox to turn off the display of waypoints' names on the ECDIS task screen.

To save the route, enter its name in the name input field and press **Save** button.



Route Loading and Unloading

In the top left part of the **Route Planning** panel, press **Load** button.

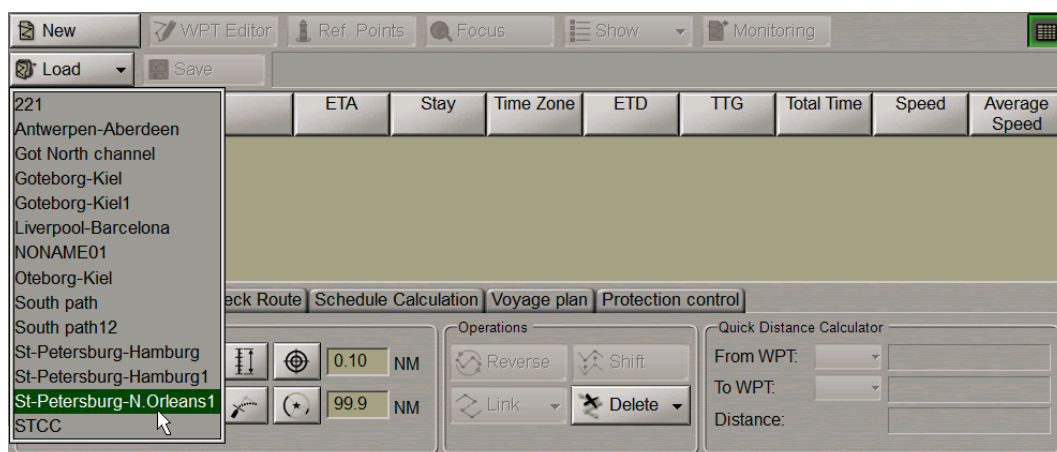

In the list, which will open up, select the route required to be loaded in edition mode, and press the left trackball\mouse button.

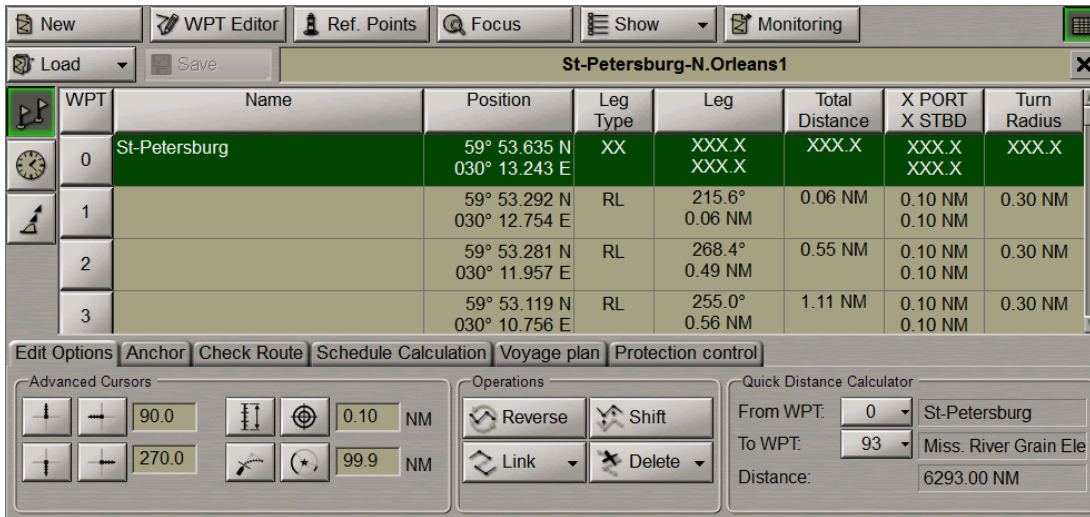

Several routes can be loaded simultaneously in the editing mode. As a button with route name is pressed, the route becomes active and can be edited on the screen by using the graphic editor.



To quick load the necessary route to monitoring mode, select it from the routes loaded in edition mode and press **Monitoring** button (see also *Multi-Functional Display (v. 3.00.340). ECDIS User Manual document, Chapter 4, Loading of Route and Schedule in the Navigation Mode* section and section *What is Different in Route Monitoring in the Route Planning* of this document):

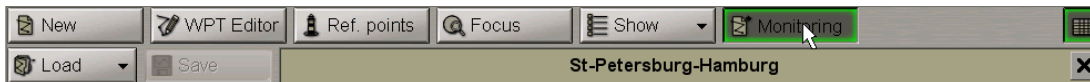

To unload the route, press the  button to the right of the route name.

Fast Route Search

Load the necessary route (see item *Route Loading and Unloading*).

In the top part of the **Route Planning** panel, press **Focus** button.

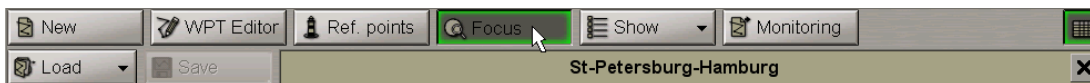

The Chart Panel will display the entire route on the suitable scale chart.

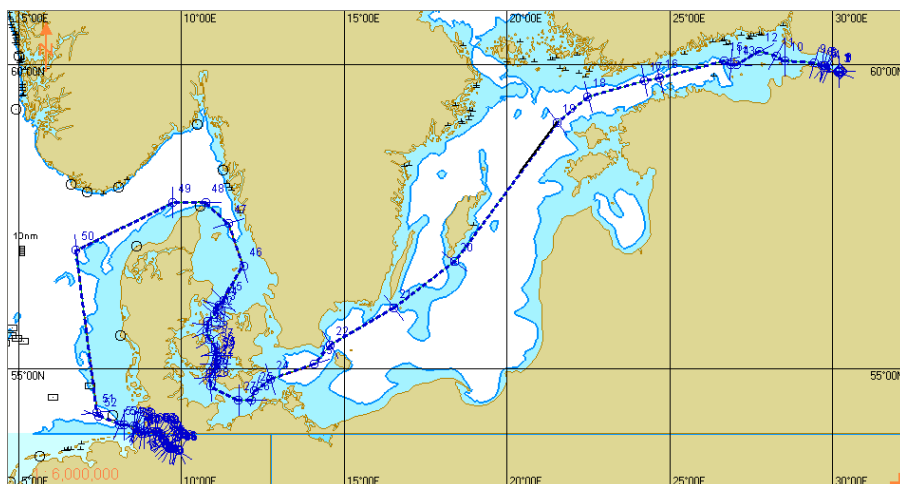

Anchoring Operations

Anchorage Planning in Route Plotting

Plot the route by using one of the procedures described above, or load the plotted route (see paragraph *Creating a Route*).

Open the **Route Planning** panel by selecting the appropriate line of the **Tasks List** menu in the tabs zone of the ECDIS task screen.

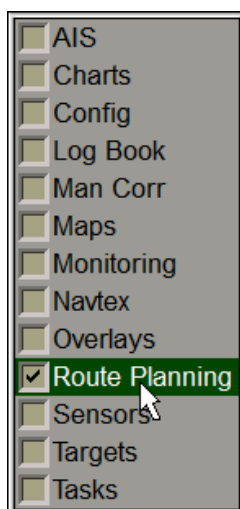

Use the tab in the top part of the **Route Planning** panel which will open up, to switch to the **Anchor** page.

WPT	Name	Position	Leg Type	Leg	Total Distance	X PORT	X STBD	Turn Radius
49		57° 49.328 N 009° 43.162 E	RL	270.2° 32.73 NM	1012.83 NM	0.10 NM	0.10 NM	0.50 NM
50		57° 01.761 N 006° 45.564 E	RL	243.6° 106.95 NM	1118.99 NM	0.10 NM	0.10 NM	0.50 NM
51	Anchorage	54° 13.117 N 007° 24.357 E	RL	172.6° 170.59 NM	1289.58 NM	0.10 NM	0.10 NM	0.50 NM
52		54° 09.112 N 007° 27.304 E	RL	156.7° 4.24 NM	1293.81 NM	0.10 NM	0.10 NM	0.50 NM

Anchor

Show anchor rings Drop Radius: 0 m Vessel Length: 220 m Depth: 0 m Save
 Cable Length: 230 m Safety Margin: 180 m Swing Radius: 630 m

During the route planning it is possible to set safe anchorage parameters in a selected WP. To this end, the own ship length (Ship Length) specified in the System Configuration utility is used (see document *Multi-Functional Display (v. 3.00.340). Installation Guide Part 1, Chapter 2, section MFD Configuration, paragraph MFD Settings*) along with the following parameters:

- Drop Radius – the “inner” circle radius within which the anchor may turn up during the dropping. The zero settings assumes that the anchor will get exactly in the WP position;
- Cable Length - anchoring cable length, cannot be lower than the Depth value;
- Safety Margin – additional range to ensure safe anchorage, can be set to zero;
- Depth – estimated depth value in the anchoring position;
- Swing Radius – radius of the “outer” circle calculated from the following formula:

$$\text{SwingRadius} = \text{ShipLength} + \text{SafetyMargin} + \sqrt{\text{CableLength}^2 - \text{Depth}^2};$$

Anchor

Show anchor rings Drop Radius: 170 m Vessel Length: 220 m Depth: 50 m Save
 Cable Length: 200 m Safety Margin: 180 m Swing Radius: 594 m

Use the **Anchor** group to set the necessary values for the parameters listed above. For the Cable Length you can use both, metres and shackles (the length of one shackle is equal to 27.5 m).

Press the **Select waypoint** button.

An acquisition marker will appear in the Chart Panel whereas the right bottom part of the screen will display the **Select waypoint** information window.

Select waypoint	
Latitude	54°13.073' N
Longitude	007°24.315' E
Ship position	
	<input type="checkbox"/> true <input type="checkbox"/> relative
Bearing	250.1 033.7 °
Opp. Bearing	070.1 148.3 °
Range	375.16 NM
Press Tab to edit manually	

Select waypoint window displays marker coordinates.

Position the acquisition marker on the anchoring WPT:

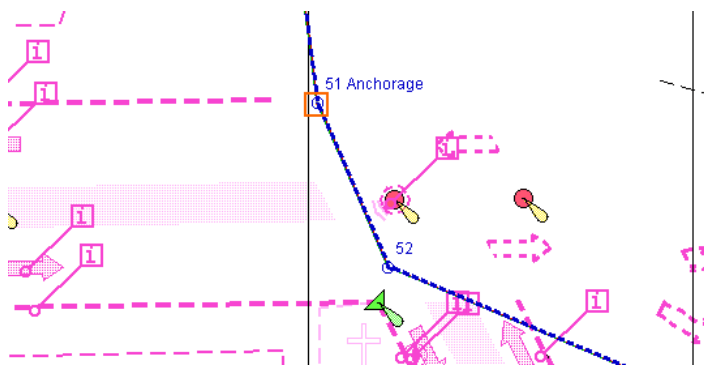

Press the left trackball button.

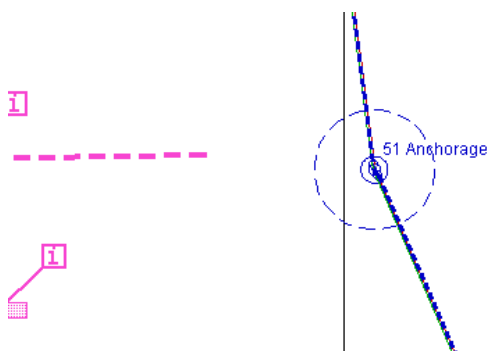

The ECDIS task screen will display the Drop Circle (a solid circle if set) and the Swing Circle (dashed circle).

Note: To this end, it is necessary to check the **Anchor rings** checkbox in the **Show** drop-down list (see section *Work with Route*, paragraph *Creating a Route*, item *Entering Additional Data*).

The settings made for the WP in question will be entered in the route, its status will be changed to edited, and the “*” symbol will be added to its name.

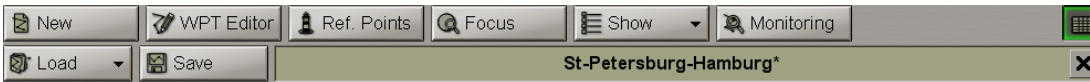

After the end of editing, the route should be saved.

Note: If some parameters have already been set for the selected WP, they will be automatically restored in the Anchor group. After changing, save them by pressing the **Save** button which will be enabled.

At the same time, the **Chart Objects** display will open up in the Control Panel:

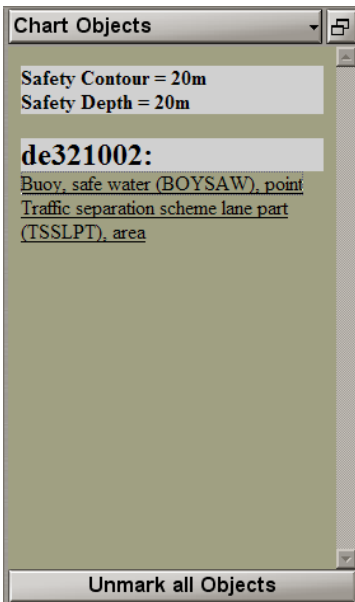

The display shows all the dangers which happen to be within the anchorage zone (Swing Circle).

The following chart objects should be considered as dangerous during the anchorage:

- Obstructions, Wrecks, Underwater rocks, Isolated dangers, Nav Aids;
- Depth contours smaller than the ship's Safety Contour;
- All objects with the “Anchorage Restricted” and “Anchorage Prohibited” attributes;
- New objects (NEWOBJ) containing dangerous object references.

Click on the dangerous object name: it will be highlighted in orange on the ECDIS task screen:

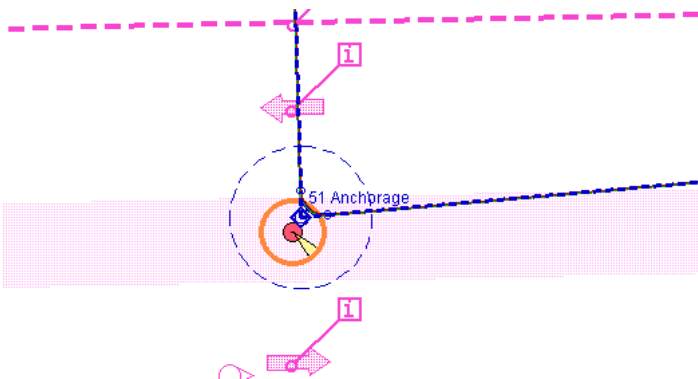

To remove the highlighting from all the dangerous objects, press the **Unmark all Objects** button.

For the user convenience sake, the graphic route plotting mode implements the display of a Drop Circle and Swing Circle on the ECDIS task screen. To this end, check the **Show anchor rings** checkbox in the **Anchor** group:

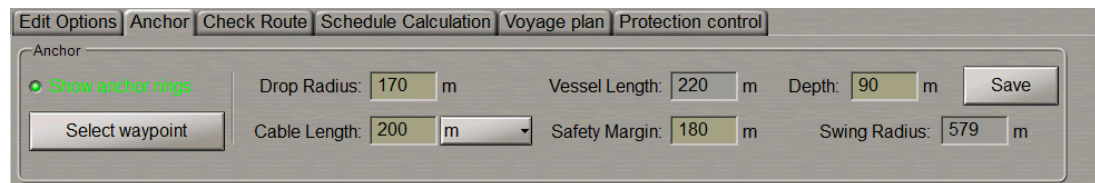

Enter the route graphic editor mode (see section *Work with Route*, paragraph *Editing the Route*, item *Graphic Route Editing Method*).

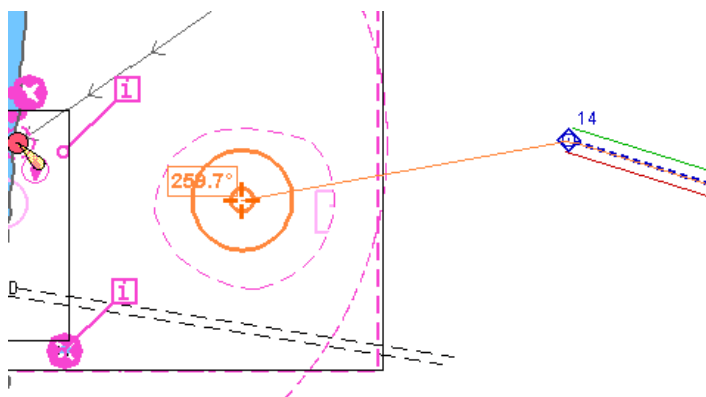

During the route plotting, the Drop Circle and Swing Circle will be shown on the ECDIS task screen in the form of solid circles.

Anchoring in Route Monitoring Mode

In the route monitoring mode, the route leg has 10 cable marks to the anchoring point. The Drop Circle (a solid circle) and the Swing Circle (a dashed circle) are shown in red, just as the monitored route.

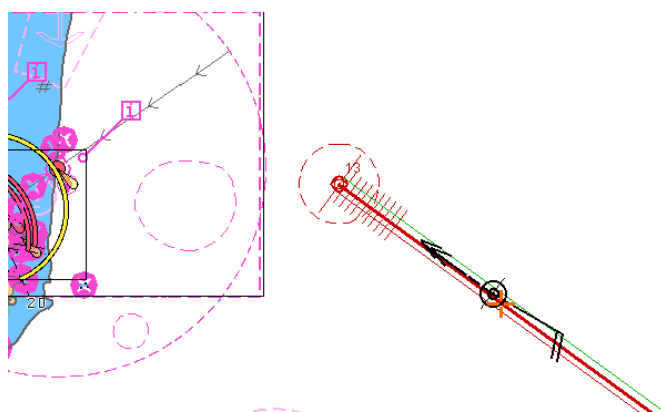

Open the Monitoring panel by selecting the appropriate line of the Tasks **List** menu in the tabs zone of the ECDIS task screen.

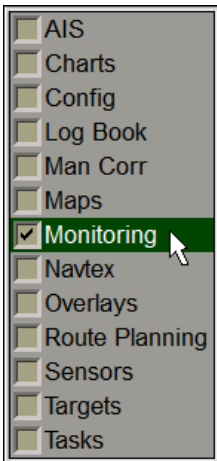

Use the tab in the top part of the Monitoring panel which will open up, to switch to the **Navigational Alerts** page.

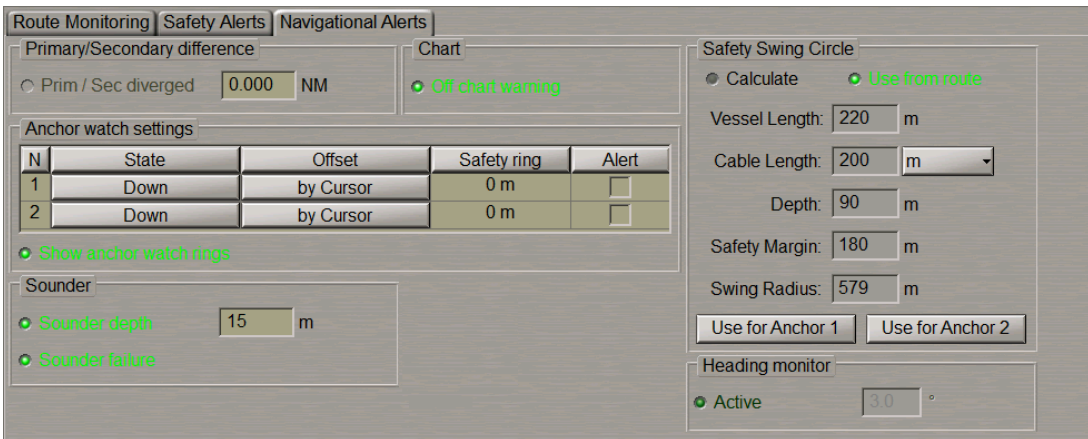

In the **Safety Swing Circle** group select the data source. If data is taken from the monitored route, select the **Use from route** radio button. If the user wishes to set new anchorage parameters (or if the data was not set before) select the **Calculate** radio button and set the necessary data (see also paragraph *Anchorage Planning in Route Plotting*).

Press the **Use for Anchor 1 (2)** button, the calculated value for the Swing Radius will be entered in the **Safety ring** column of the **Anchor watch settings** table.

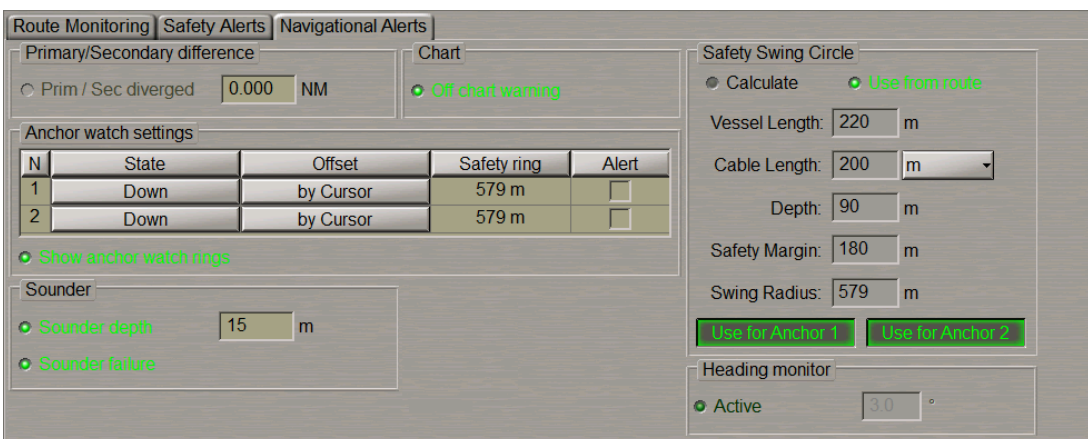

Check the checkboxes in the **Alert** column to turn on the alert generation as the ship sails beyond the set distances.

Check the **Show anchor watch rings** checkbox to show the anchor watch rings around the anchor position after the anchor drop points are set.

To set the position of 1 anchor, press the **Down** button in the row 1.

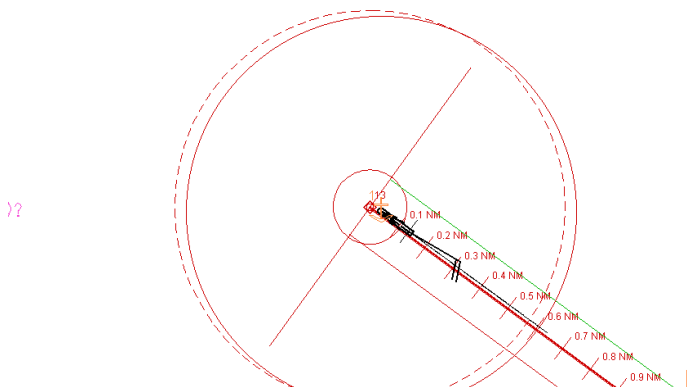

In this case, the anchor position will correspond to the position of anchor point 1 at the moment when the **Down** button is pressed. The anchor position is marked with the special  symbol specifying the anchor number.

At the same time the **Chart Objects** display will open up on the Control Panel:

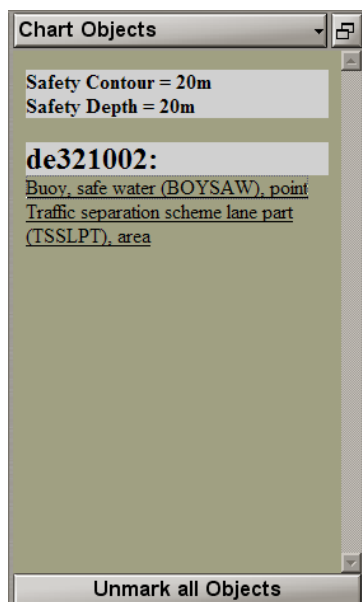

The display shows all the danger which happen to be within the anchorage zone (Swing Circle).

At this time it is advisable to unload the monitored route for decluttering the ECDIS task screen.

Along the line connecting the positions of the anchor and anchor point 1, bearing and distance between them is dynamically displayed.

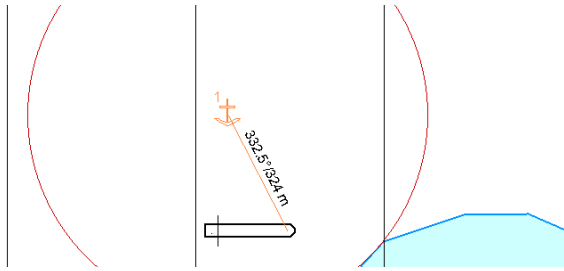

To set the anchor position, use the cursor to press the **By Cursor** button in row 1. Indicate the anchor position with the cursor on the Chart Panel.

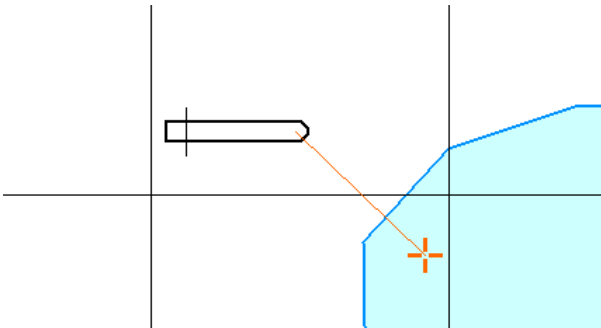

Press the left trackball button. Use similar procedures if it is necessary to set anchor 2.

Editing the Route

Graphic Route Editing Method

Load the necessary route (see *Route Loading and Unloading* item).

In the top part of the **Route Planning** panel, press **WP Editor** button.



An acquisition marker will appear in the Chart Panel whereas the right bottom part of the screen will display **Edit route** information window.



Edit route window displays marker coordinates.

1. Changing Coordinates of an Existing WPT:

Position the acquisition marker on the WPT to be edited.

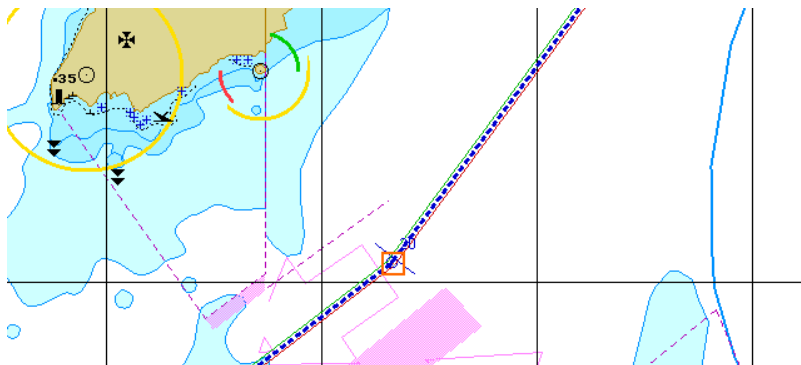

Press the left trackball/mouse button: the marker will acquire the WPT and change own form.

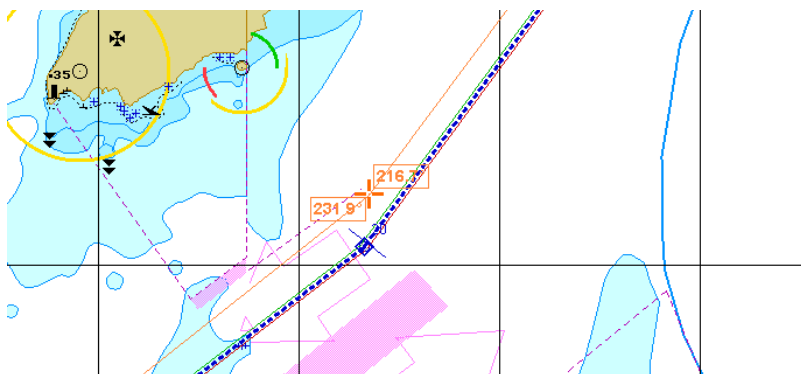

Move the acquired WPT to the required place. As the WPT coordinates change, the adjacent route legs will change, too.

Press the left trackball/mouse button.

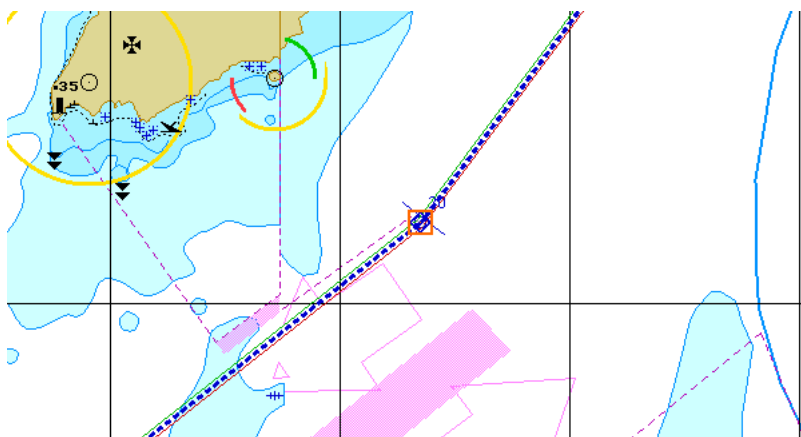

The WPT will be set in the new coordinates.

2. Setting a New WPT:

Position the acquisition marker on the route leg where a new WPT is required to be set.

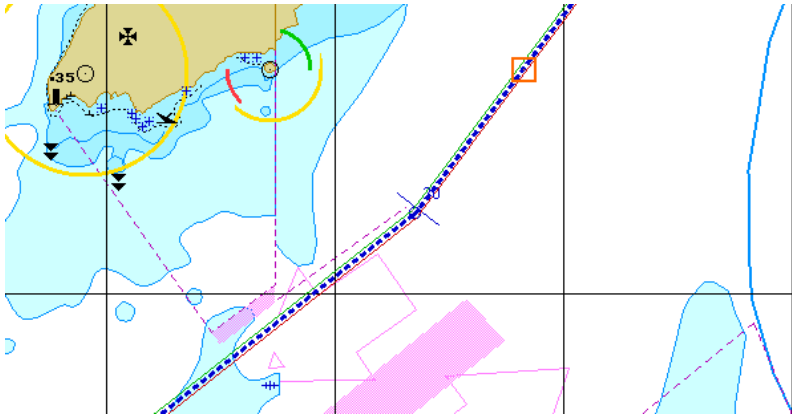

Press the left trackball/mouse button: a new WPT will be set. The marker will acquire the new WPT and change own form.

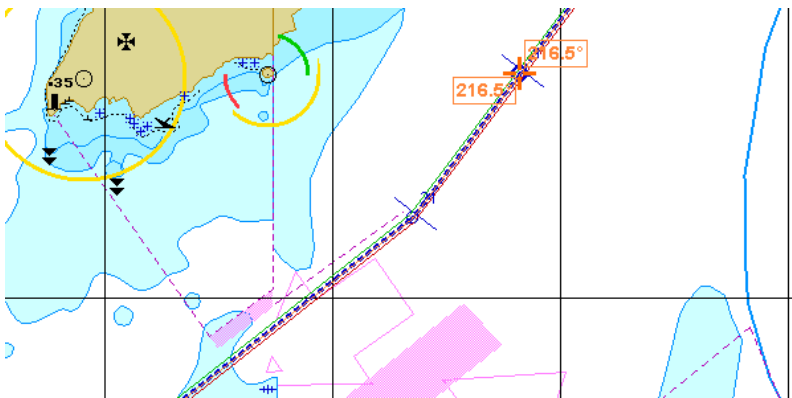

Move the acquired WPT to the necessary place.

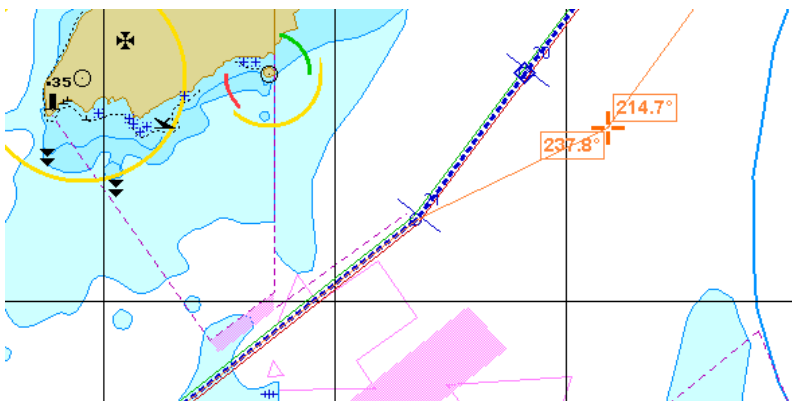

As the WPT coordinates change, the adjacent route legs will change, too.

Press the left trackball/mouse button. The new WPT will be set in the specified coordinates.

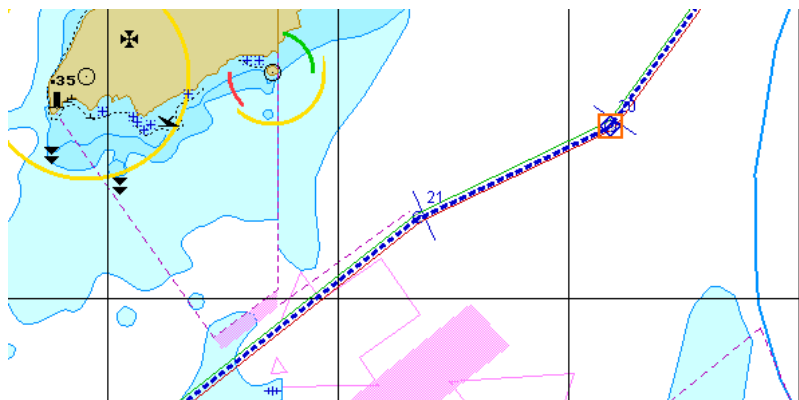

3. Deleting a WPT:

Position the acquisition marker on the WPT to be deleted.

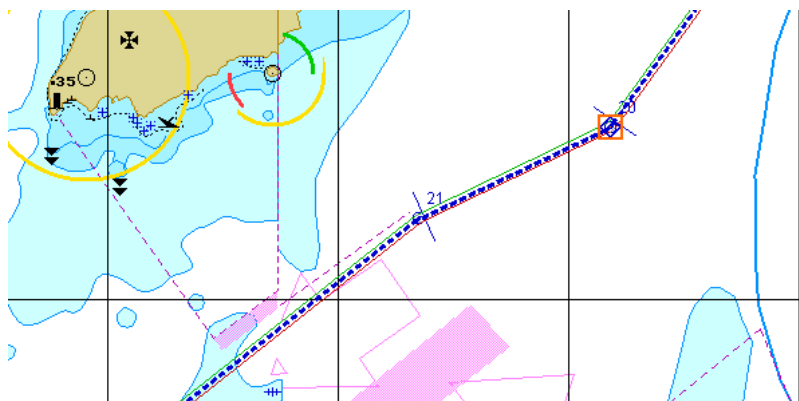

Press the left trackball/mouse button: the marker will acquire the WPT and change own form.

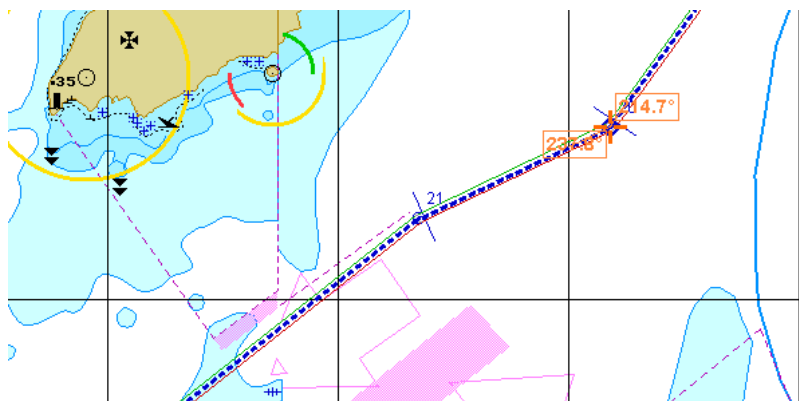

Press the right trackball/mouse button.

The point will be deleted, and the adjacent route legs will be combined to form one.

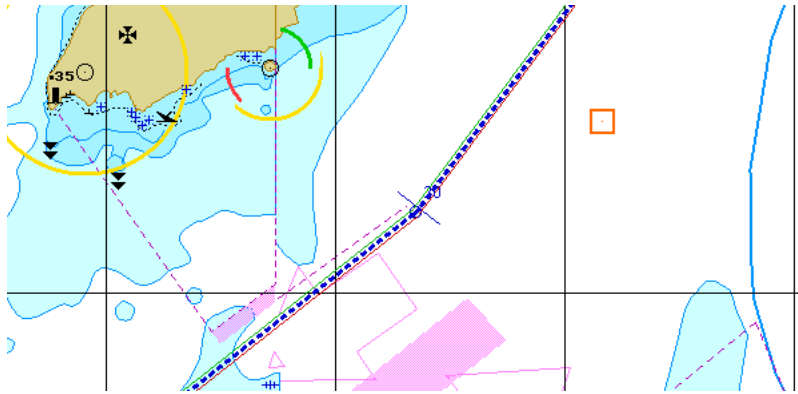

Press the right trackball/mouse button to exit from the editing mode. The marker will assume the shape of the free cursor.

Save the route as required (see *Creating a Route* paragraph).

Tabular Route Editing Method

Load the necessary route (see *Route Loading and Unloading* item).

The display of the table is turned on/off by using the Show tables button.



In the left part of the **Route Planning** panel, press the button to display the corresponding table.



WPT	Name	Position	Leg Type	Leg	Total Distance	X PORT X STBD	Turn Radius
0	St-Petersburg	59° 53.635 N 030° 13.243 E	XX	XXX.X XXX.X	XXX.X	XXX.X XXX.X	XXX.X
1		59° 53.292 N 030° 12.754 E	RL	215.6° 0.06 NM	0.06 NM	0.10 NM 0.10 NM	0.30 NM
2		59° 53.281 N 030° 11.957 E	RL	268.4° 0.49 NM	0.55 NM	0.10 NM 0.10 NM	0.30 NM
3		59° 53.119 N 030° 10.756 E	RL	255.0° 0.56 NM	1.11 NM	0.10 NM 0.10 NM	0.30 NM

Edit Options | Anchor | Check Route | Schedule Calculation | Voyage plan | Protection control

Advanced Cursors: 90.0, 270.0, 0.10 NM, 99.9 NM

Operations: Reverse, Shift, Link, Delete

Quick Distance Calculator: From WPT: 0 (St-Petersburg), To WPT: 93 (Miss. River Grain Ele), Distance: 6293.00 NM

Edit the existing route by using the following procedures.

1. Edit coordinates and route elements for an existing WPT as described in item *Creating a Route*.
2. Setting a New WPT:

Position the cursor on the cell with the number of the WPT before which a new WPT is required to be added, press the left trackball/mouse button. This WPT line will be highlighted in colour.

WPT	Name	Position	Leg Type	Leg	Total Distance	X PORT X STBD	Turn Radius
9		60° 01.736 N 029° 25.785 E	RL	287.7° 7.97 NM	25.74 NM	0.10 NM 0.10 NM	0.50 NM
10		60° 03.242 N 028° 31.410 E	RL	273.2° 27.25 NM	52.98 NM	0.10 NM 0.10 NM	0.50 NM
11		60° 07.832 N 028° 16.433 E	RL	301.5° 8.85 NM	61.84 NM	0.10 NM 0.10 NM	0.50 NM
12		60° 12.302 N 027° 45.312 E	RL	286.1° 16.03 NM	77.87 NM	0.10 NM 0.10 NM	0.50 NM

Press the <Insert> key of the computer keyboard, or press the right trackball/mouse button and select the **Insert waypoint** context menu item. A new line containing the same number and coordinates corresponding to the middle of the leg, which it is set on, will appear. The old line will be assigned the next number.

WPT	Name	Position	Leg Type	Leg	Total Distance	X PORT X STBD	Turn Radius
9		60° 01.736 N 029° 25.785 E	RL	287.7° 7.97 NM	25.74 NM	0.10 NM 0.10 NM	0.50 NM
10		60° 02.489 N 028° 58.603 E	RL	273.2° 13.72 NM	39.45 NM	0.10 NM 0.10 NM	0.50 NM
11		60° 03.242 N 028° 31.410 E	RL	273.2° 13.53 NM	52.98 NM	0.10 NM 0.10 NM	0.50 NM
12		60° 07.832 N 028° 16.433 E	RL	301.5° 8.85 NM	61.84 NM	0.10 NM 0.10 NM	0.50 NM

Edit the route element value.

3. Deleting a WPT:

Position the cursor on the cell with the number of the WPT required to be deleted, press the left trackball/mouse button. This WPT line will be highlighted in colour.

WPT	Name	Position	Leg Type	Leg	Total Distance	X PORT X STBD	Turn Radius
9		60° 01.736 N 029° 25.785 E	RL	287.7° 7.97 NM	25.74 NM	0.10 NM 0.10 NM	0.50 NM
10		60° 02.489 N 028° 58.603 E	RL	273.2° 13.72 NM	39.45 NM	0.10 NM 0.10 NM	0.50 NM
11		60° 03.242 N 028° 31.410 E	RL	273.2° 13.53 NM	52.98 NM	0.10 NM 0.10 NM	0.50 NM
12		60° 07.832 N 028° 16.433 E	RL	301.5° 8.85 NM	61.84 NM	0.10 NM 0.10 NM	0.50 NM

Press <Delete> key on the computer keyboard, or press the right trackball/mouse button and select **Delete waypoints** context menu item.

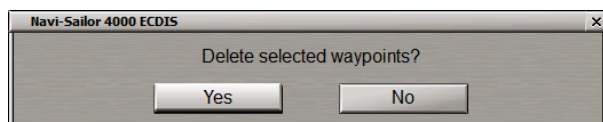

Press **Yes** button to confirm the WPT deleting.

The selected line will be deleted, those following it will be re-numbered.

WPT	Name	Position	Leg Type	Leg	Total Distance	X PORT X STBD	Turn Radius
9		60° 01.736 N 029° 25.785 E	RL	287.7° 7.97 NM	25.74 NM	0.10 NM 0.10 NM	0.50 NM
10		60° 03.242 N 028° 31.410 E	RL	273.2° 27.25 NM	52.98 NM	0.10 NM 0.10 NM	0.50 NM
11		60° 07.832 N 028° 16.433 E	RL	301.5° 8.85 NM	61.84 NM	0.10 NM 0.10 NM	0.50 NM
12		60° 12.302 N 027° 45.312 E	RL	286.1° 16.03 NM	77.87 NM	0.10 NM 0.10 NM	0.50 NM

All the changes in the table will be reflected accordingly on the graphic screen.

Save the route as required by pressing **Save** button in the top right part of the panel.

Shifting a Route

Load the necessary route (see *Route Loading and Unloading* item).

Switch to **Edit Options** page. Press **Shift** button in **Operations** group.

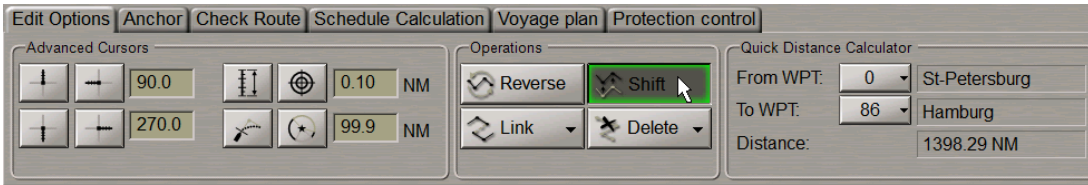

An acquisition marker will appear in the Chart Panel whereas the right bottom part of the screen will display **Edit Route** information window.



Edit route window displays marker coordinates.

Position the acquisition marker on any point of the route which should be moved.

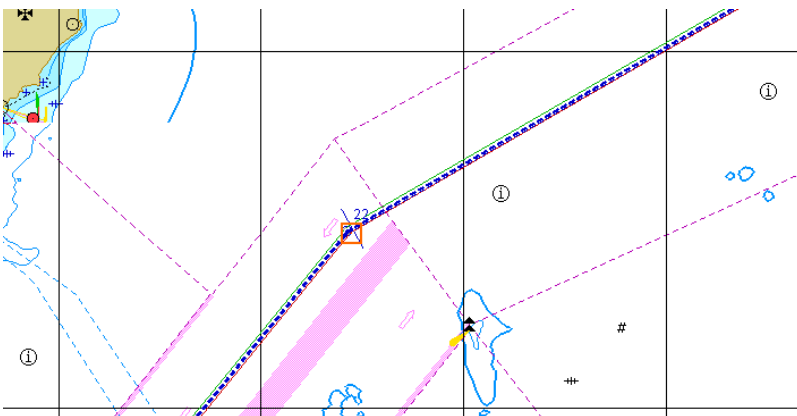

Press the left trackball/mouse button: the marker will change own form.

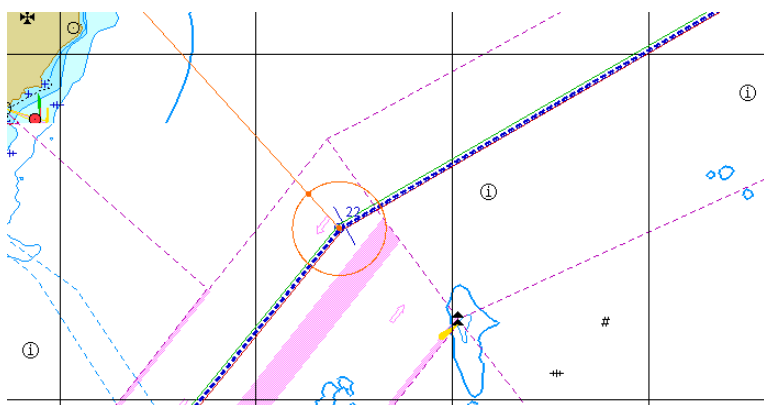

Move the route to the required place. The shift bearing and distance will be displayed in the **Shift Route** information window in the right bottom part of the screen.

Shift	
Latitude 1	57°08.659' N
Longitude 1	019°18.008' E
Latitude 2	57°59.659' N
Longitude 2	019°08.008' E
From point 1	
Bearing	289.3 °
Opp. Bearing	119.3 °
Range	2.31 NM
	3761 m
Press Tab to edit manually	

Press the left trackball/mouse button.

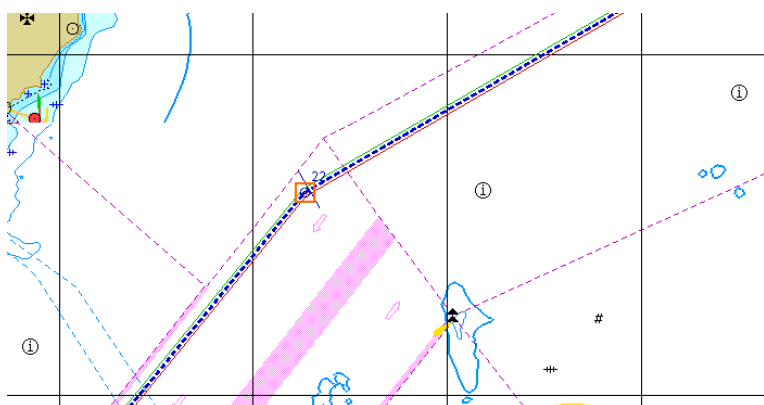

The route will be shifted.

Note: All the WPT's of the selected route will be shifted by the selected distance and bearing.

Press the right trackball/mouse button to exit from the editing mode. The marker will assume the shape of the free cursor.

Save the route as required (see *Creating a Route* item).

Creating Reversed Route

Load the necessary route (see *Route Loading and Unloading* item).

Switch to **Edit Options** page. Press **Reverse** button in **Operations** group.

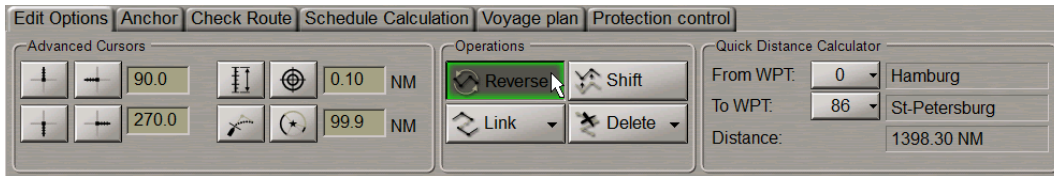

A route will be created with the WPT order inverse to that in the active route.

All the changes in the table will be shown accordingly on the Chart Panel.

Save the route as required (see *Creating a Route* item).

Merging Routes

Load the necessary route (see *Route Loading and Unloading* item).

Switch to **Edit Options** page. Press **Link** button in **Operations** group.

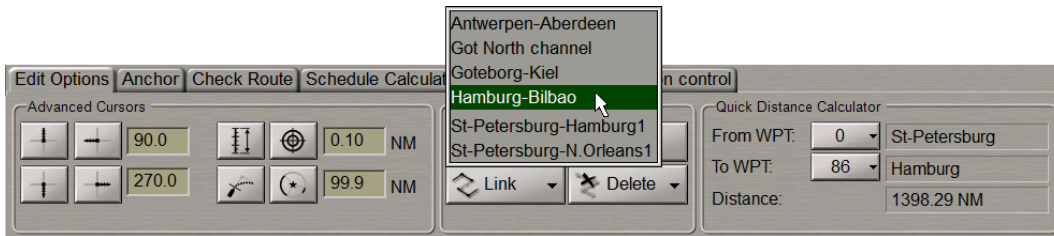

In the list, which will open up, select the route, which will be connected to the last point of the loaded route. Press the left trackball/mouse button.

WPT's of the connected route will be added to the table of route elements.

All the changes in the table will be shown accordingly on the Chart Panel.

Save the route as required (see *Creating a Route* item).

Deleting a Route

Switch to **Edit Options** page. Press **Delete** button in **Operations** group.

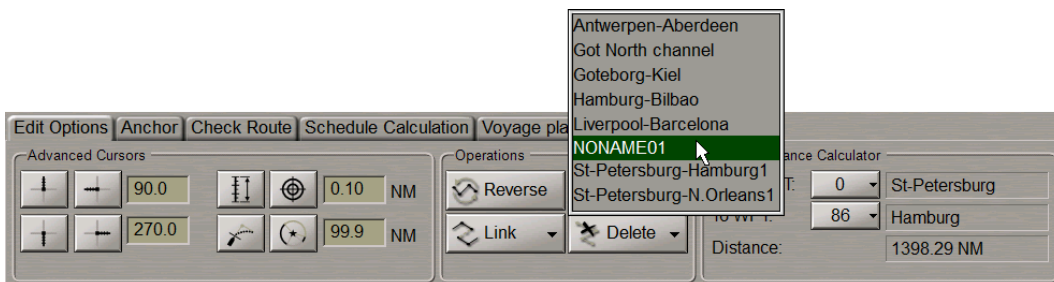

Select the route, which should be deleted, from the list and press the left trackball/mouse button.

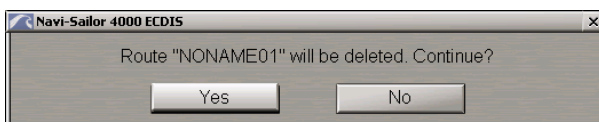

In the window which will appear, press **Yes** button to confirm the deleting. The route will be deleted.



Attention! The route cannot be deleted until it is loaded into monitoring or editing mode.

Checking and Editing the Route Taking into Account Dangers to Navigation

Load the route, which should be checked for the availability of dangers to navigation (see *Route Loading and Unloading* item).

Switch to **Check route** page.

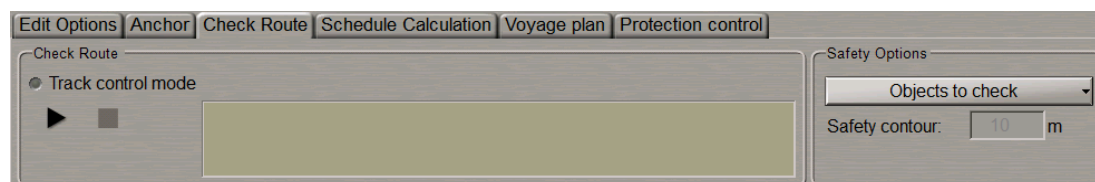

In the **Safety options** group select which charts should be used for the check: only charts with **Best scale** or all charts (**All scales**) under the checked route (see document *Multi-Functional Display (v. 3.00.340). Functional Description, Chapter 4, section Main Alerts Generation Principles, paragraph Safety Alerts*).

Press  button in **Check route** group: the route will be checked.



The list of chart objects and safety contour value, which are used in the route check displayed in the **Safety options** group.

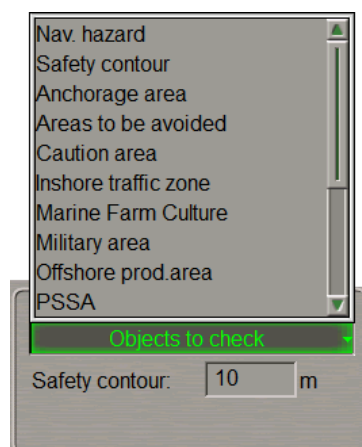

The check process is shown in the display window.

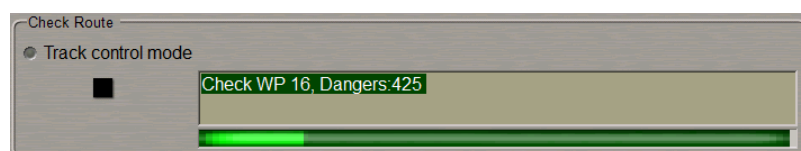

Press  button if necessary to interrupt manually the check of the entire active route for the availability of dangers to navigation.





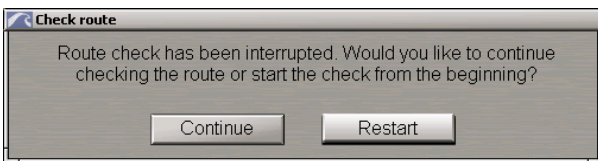

The route check will be interrupted. It can be resumed after the necessary time without exiting from the route checking mode. To do this, press the  button.



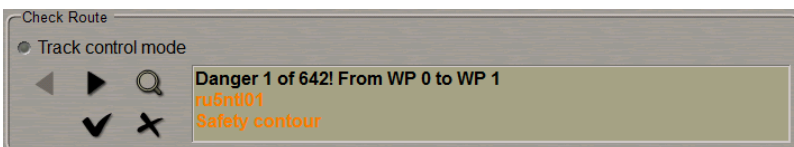

Select the necessary option, the route check will be resumed.

After the end of check, **Check route** group will display a message about detected dangers or about no dangers having been found.

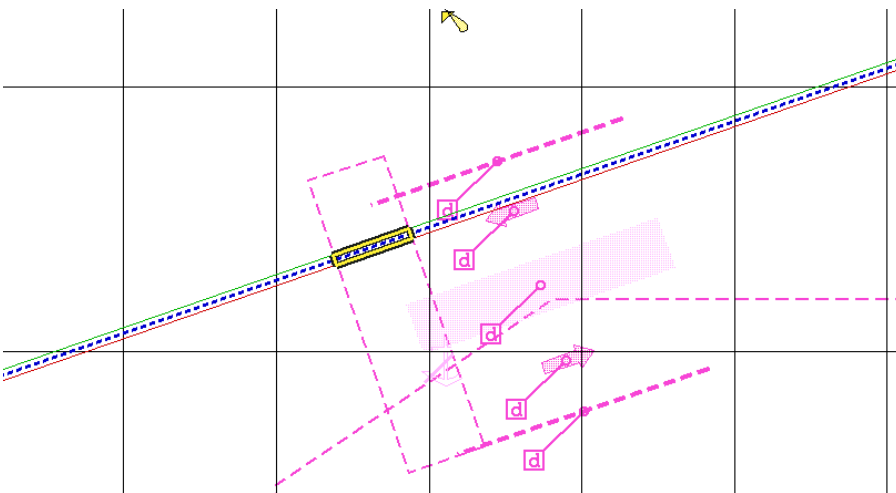

To view the detected dangers to navigation, use  and  buttons to select the danger you are interested in. Press  button. The danger to navigation will be indicated by highlighting on the Chart Panel. In this case the best chart of the original scale will be loaded.



To edit route to take into account the detected dangers to navigation, use  and  buttons to select the required danger and press **WPT Editor** button.

An acquisition marker will appear on the Chart panel in the point with coordinates of the detected danger to navigation.

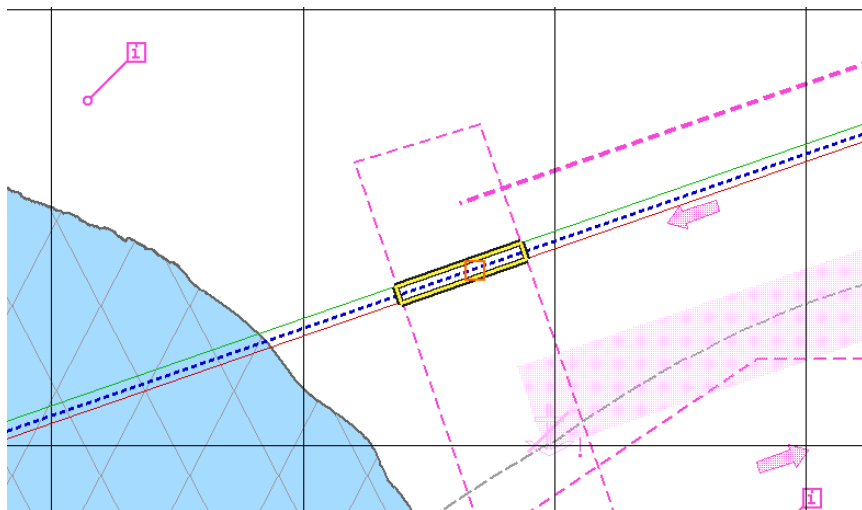

Edit the route leg according to the editing rules so that the route leg does not pass through the dangerous place. E.g., change the WPT position.

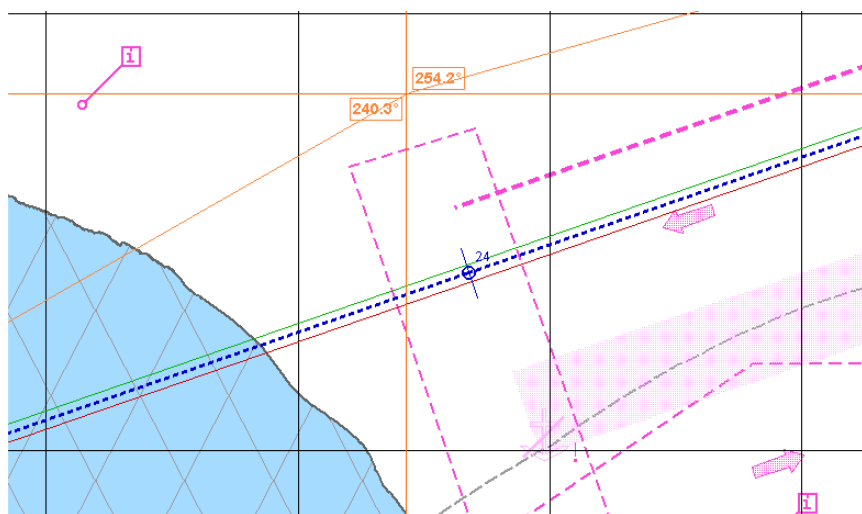

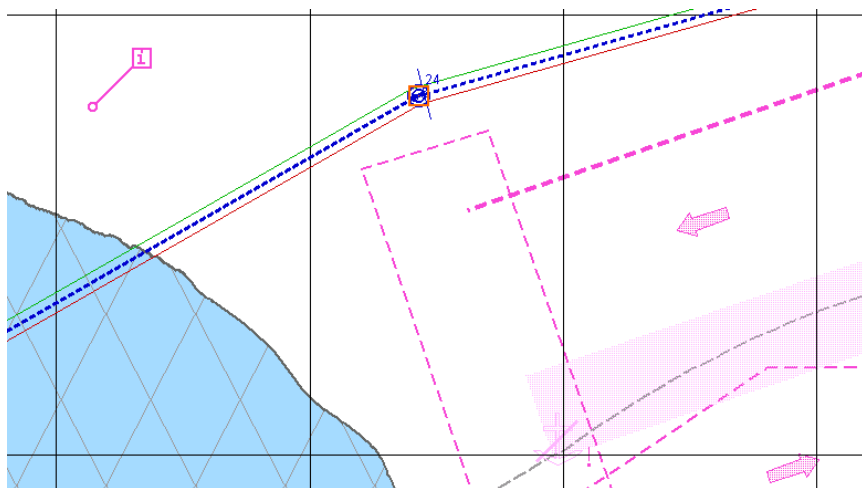

After the route leg editing is completed, press the left trackball button. After the change of the WPT position, two legs before the changed point and two legs after it will be automatically checked.

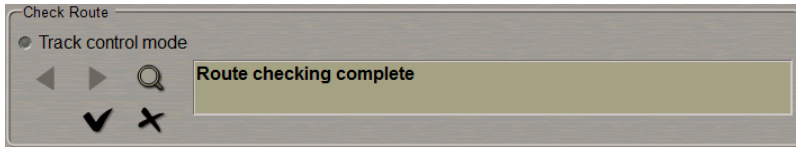

Perform the editing until the end of the route (see also section *Route Editor*, paragraph *Graphic Route Editing Method*).

If there are no dangers to navigation on the route, **Check route** group will display an appropriate message.



To accept the route checking results and exit from the checking mode press  button. The "checked" attribute will be assigned to the route. Check results will be entered in the voyage plan, the following window will open up.

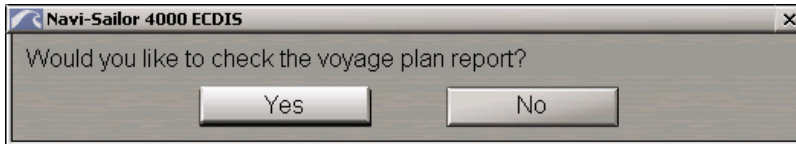

To view check results, press the **Yes** button.

Print Preview

PDF HTML Excel Page 1 of 35

VPT	Name	Position	Leg	Total Distance	X PORT X STBD	Turn Radius	Draught	Squat	UKC
0	St-Petersburg	59° 53.844 N 030° 13.608 E	XXXX XXXX X	XXXX	XXXX XXXX X	XXXX	XXXX	XXXX	XXXX
1		59° 53.292 N 030° 12.754 E	214.5° 0.22 NM	0.22 NM	0.10 NM 0.10 NM	0.50 NM	10.0 m	0.5 m	Shallow water
2		59° 53.236 N 030° 11.608 E	264.4° 0.74 NM	0.96 NM	0.10 NM 0.10 NM	0.50 NM	10.0 m	0.5 m	Shallow water
3		59° 53.119 N 030° 10.756 E	254.7° 0.32 NM	1.28 NM	0.10 NM 0.10 NM	0.50 NM	10.0 m	0.5 m	Shallow water
4		59° 56.852 N 029° 52.510 E	292.2° 10.07 NM	11.35 NM	0.10 NM 0.10 NM	0.50 NM	10.0 m	0.5 m	Shallow water
5	Pilot buoy	59° 57.756 N 029° 47.762 E	290.5° 2.46 NM	13.81 NM	0.10 NM 0.10 NM	0.50 NM	10.0 m	0.5 m	Shallow water
6		59° 58.845 N 029° 45.408 E	312.7° 1.59 NM	15.40 NM	0.10 NM 0.10 NM	0.50 NM	10.0 m	0.5 m	Shallow water
7		59° 59.094 N 029° 43.732 E	286.5° 0.96 NM	16.36 NM	0.10 NM 0.10 NM	0.50 NM	10.0 m	0.5 m	Shallow water
8		59° 59.309 N 029° 40.950 E	278.5° 1.41 NM	17.77 NM	0.10 NM 0.10 NM	0.50 NM	10.0 m	0.5 m	Shallow water
9		60° 01.736 N 029° 25.785 E	287.7° 7.97 NM	25.74 NM	0.10 NM 0.10 NM	0.50 NM	10.0 m	0.5 m	Shallow water
10		60° 03.242 N 028° 31.410 E	273.2° 27.25 NM	52.98 NM	0.10 NM 0.10 NM	0.50 NM	10.0 m	0.5 m	9.5 m
11		60° 07.832 N 028° 16.433 E	301.5° 8.85 NM	61.84 NM	0.10 NM 0.10 NM	0.50 NM	10.0 m	0.5 m	9.5 m
12		60° 12.302 N 027° 45.312 E	286.1° 16.03 NM	77.87 NM	0.10 NM 0.10 NM	0.50 NM	10.0 m	0.5 m	9.5 m
13		59° 59.628 N 027° 02.751 E	239.2° 24.85 NM	102.72 NM	0.10 NM 0.10 NM	0.50 NM	10.0 m	0.5 m	9.5 m
14		59° 59.961 N 026° 52.897 E	273.9° 5.00 NM	107.72 NM	0.10 NM 0.10 NM	0.50 NM	10.0 m	0.5 m	9.5 m
15		60° 03.238 N 026° 42.045 E	297.0° 7.15 NM	114.87 NM	0.10 NM 0.10 NM	0.50 NM	10.0 m	0.5 m	9.5 m
16		59° 47.940 N 024° 41.208 E	255.5° 51.90 NM	176.77 NM	0.10 NM 0.10 NM	0.50 NM	10.0 m	0.5 m	Shallow water

Printed: 12/12/15 17:35:17 Prepared by nav. Officer: Checked by Master: Page 1

The Voyage Plan table on the Safety Parameters page specifies safety parameters which were used for checking each route leg. The List of Accepted Alerts column lists dangers which were found during the route check but were ignored by the user. If no dangers were found on these legs, cells of the List of Accepted Alerts column will be empty. Specified in the brackets are charts on which dangers were detected, as well as danger depths for the safety contour and safety depth. The Voyage Plan footer displays: **Check for safety: 07.10.12 13:25** (date and time of the check).

To save check results, export the voyage plan in one of the formats (*.pdf, *.html, *.xls) by pressing the respective button in the left top corner (PDF, HTML, Excel) of the **Print Preview** window.



Attention! As the route is unloaded, data in the List of Accepted Alerts column is not saved.

The saved files have the `Route_name_(DD.MM.YY,HH-MM_checked) .*` format specifying the status (checked), check time and date.

To exit from checking mode without the results of the route checking acceptance and press  button.

For checking route geometry for compliance with Track Control Mode, press **Track control mode** radio button.

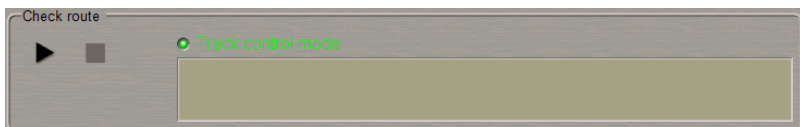

For the reference purpose, in the **Track control** group specifies limitations for the route elements required for Track Control mode operation.

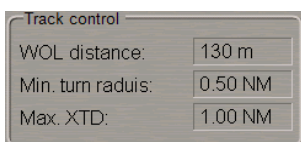

Use the same procedure to check the route as described above for safety parameters.

Route Approval and Protection

Protecting Route from Editing

Plot the route by using one of the procedures described above, or load the plotted route (see *Creating a Route* paragraph).

Use the tab in the top part of the **Route Planning** panel which will open up, to switch to the **Protection control** page.

WPT	Name	ETA	Stay	Time Zone	ETD	TTG	Total Time	Speed	Average Speed
0	St-Petersburg	XX-XX-XX XX:XX	XX-XX-XX XX:XX	00:00	23-12-13 22:00	XX-XX-XX	XX-XX-XX	XXX.X	XXX.X
1		23-12-13 22:01		00:00	23-12-13 22:01	00 d 00 h 01 m	00 d 00 h 01 m	12.0 kn	12.0 kn
2		23-12-13 22:03		00:00	23-12-13 22:03	00 d 00 h 02 m	00 d 00 h 03 m	12.0 kn	12.0 kn
3		23-12-13 22:06		00:00	23-12-13 22:06	00 d 00 h 02 m	00 d 00 h 06 m	12.0 kn	12.0 kn

Protection control group:

Press the **Protect** button in the **Protection control** group.

If NS 4100 logon had a low access level which does not allow route protection (see document *Navi-Sailor 4100 ECDIS (v. 2.00.348). Special Functions*, chapter *NS 4100 Security Access System*, section *Levels/Passwords Page*, paragraph *Assigning Access Levels*), a special warning will appear:

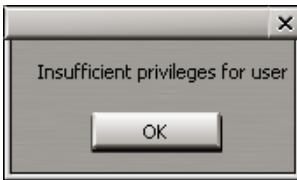

Press the **OK** button, a request to enter a password will appear:

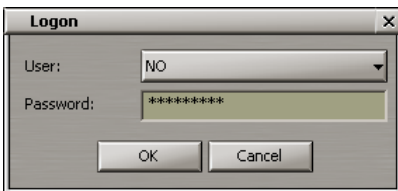

Enter the password for the appropriate access level. Press the **OK** button. The route will be protected from editing, and the letter “[P]” will be added to its name.

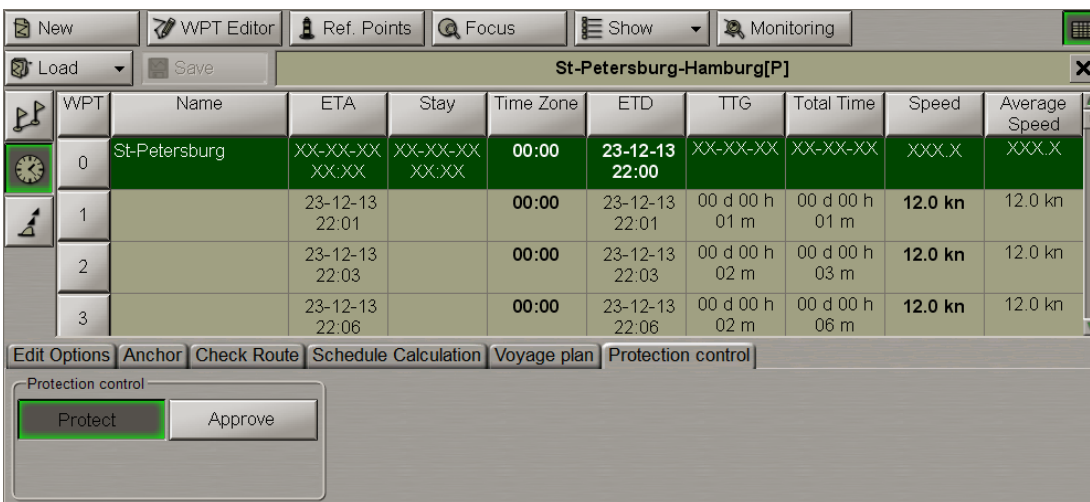

The protected route can neither be saved under the previous name, nor deleted. If saved under an altered name, the route loses its “Protected” status.

In the list of routes, the protected route is marked off with bold type:

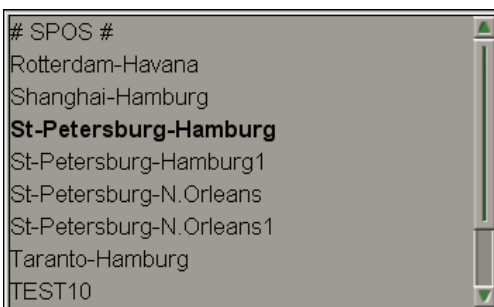

Route Approval



Attention! This feature is available for Navi-Sailor 4100 software only.

Plot the route by using one of the procedures described above, or load the plotted route (see paragraph *Creating a Route*).

Use the tab in the top part of the **Route Planning** panel which will open up, to switch to **Protection control** page.

WPT	Name	ETA	Stay	Time Zone	ETD	TTG	Total Time	Speed	Average Speed
0	St-Petersburg	XX-XX-XX XX:XX	XX-XX-XX XX:XX	00:00	23-12-13 22:00	XX-XX-XX	XX-XX-XX	XXX.X	XXX.X
1		23-12-13 22:01		00:00	23-12-13 22:01	00 d 00 h 01 m	00 d 00 h 01 m	12.0 kn	12.0 kn
2		23-12-13 22:03		00:00	23-12-13 22:03	00 d 00 h 02 m	00 d 00 h 03 m	12.0 kn	12.0 kn
3		23-12-13 22:06		00:00	23-12-13 22:06	00 d 00 h 02 m	00 d 00 h 06 m	12.0 kn	12.0 kn

Protection control

Protect Approve



Attention! For the route to be approved, it should be checked for dangers to navigation on the **Check Route** page of the **Route Planning** panel.

If the route has not been checked for dangers, the following warning will be displayed after a press on the **Approve** button:

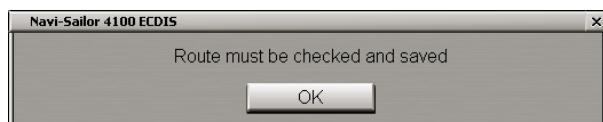

Check the route for the availability of dangers to navigation (see paragraph *Checking and Editing the Route Taking into Account Dangers to Navigation*). After the check, press the enabled **Approve** button in the **Protection control** group. If NS 4100 logon had a low access level which does not allow route protection (see document *Navi-Sailor 4100 ECDIS (v. 2.00.348). Special Functions*, chapter *NS 4100 Security Access System*, section *Levels/Passwords Page*, paragraph *Assigning Access Levels*), a special warning will appear:

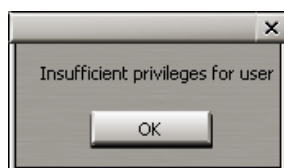

Press the **OK** button, a request to enter a password will appear:

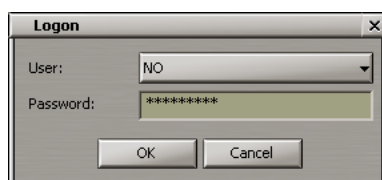

Enter the password for the appropriate access level. Press the **OK** button.

The route will be approved, and the letter “[A]” will be added to its name.

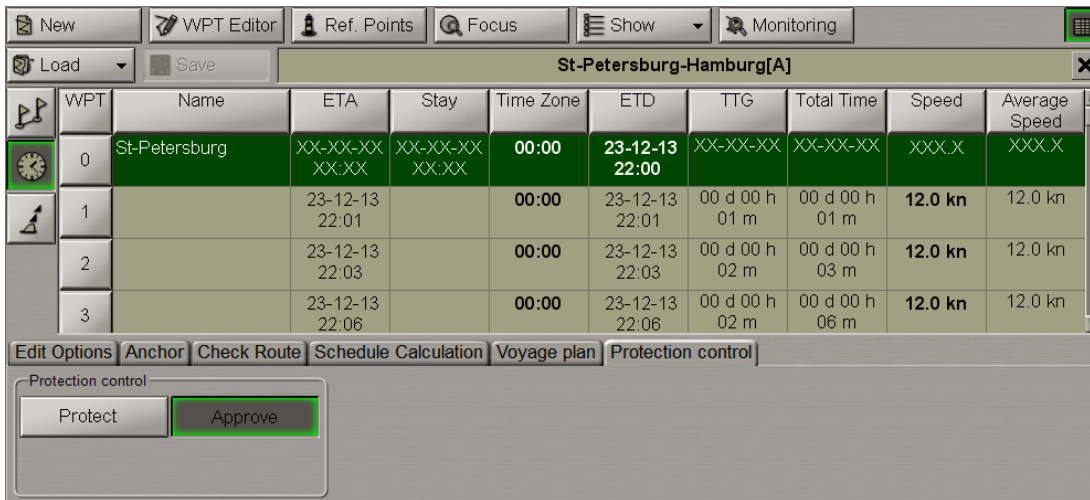

The approved route only can be loaded for monitoring, if the appropriated checkbox is checked (by default the checkbox is unchecked) on the **Permissions** page of **Security** panel in the System Configuration utility (see documents *Multi-Functional Display (v. 3.00.340). Installation Guide part I, Chapter 2, section MFD Configuration*, paragraph *Security Settings for NS 4100* and *Multi-Functional Display (v. 3.00.340). Special Functions*, chapter *NS 4100 Security Access System*, section *Permissions Page*). Only SAR routes created on the **SAR** page of the **Tasks** panel (see document *Multi-Functional Display (v. 3.00.340). ECDIS User Manual, Chapter 4, section Search and Rescue Operations*, paragraph *Creating SAR Routes*) can be loaded for monitoring from that page without approval.

In the list of route, the approved routes are marked off with colour:

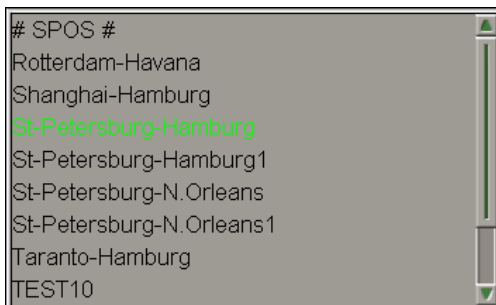

Routes Exchange with SPOS

When a voyage plan created, it is possible to supplement the voyage plan with weather data by using the external SW – SPOS, the official Meteo Consult’s product.

The SPOS program can exchange routes with the MFD as well as to process the routes created in the MFD taking the weather conditions into account.

Load the route intended for the joint use with the SPOS utility (see paragraph *Work with Route*, item *Route Loading and Unloading*).

Switch to **Voyage plan** page.



Press **Request** button in SPOS group.

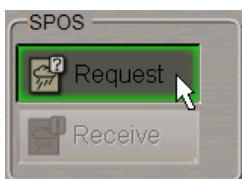

Create the SPOS route (see document *Multi-Functional Display (v. 3.00.340). Utilities, Chapter 7*).

In the MFD, switch to **Voyage plan** page.



To import a route processed by using the SPOS utility, press the **Receive** button in SPOS group.



The message contains information about route extension by SPOS weather data will be displayed:

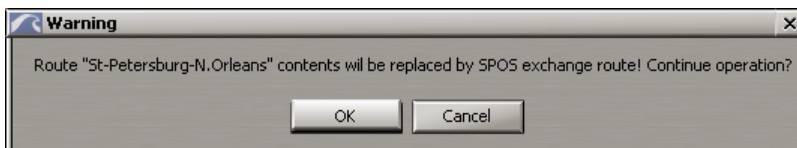

Press **OK** button.

The route imported from the SPOS program will contain the route time schedule with forecasted weather conditions taken into account.

Note: The routes calculated in the SPOS program by pressing the **Great Circle**, **Rhumb line** and **Composite** buttons will contain original waypoints created in the Navi-Sailor 4000 application only; their names and coordinates will not be changed. Routes calculated by pressing the **Optimum** button, will contain the above-mentioned waypoints plus intermediate waypoints created by the SPOS program during calculation. These waypoints will be named "Spos xx".

Work with Schedule

Drawing a Schedule

Load the route for which the schedule will be drawn for (see paragraph *Work with Route*, item *Route Loading and Unloading*).

The display of the table is turned on/off by using the **Show tables** button.



In the left part of the **Route Planning** panel, press the button to display the corresponding table.



The screenshot shows a software window titled "St-Petersburg-Hamburg" with a table and a control panel below it.

WPT	Name	ETA	Stay	Time zone	ETD	TTG	Total time	Speed	Average speed
0	St-Petersburg	XX-XX-XX XX:XX	XX-XX-XX XX:XX			XX-XX-XX	XX-XX-XX	XXX.X	XXX.X
1									
2									
3									

Below the table is a control panel with tabs: Edit Options, Anchor, Check Route, Schedule Calculation, Voyage plan, Protection control. The "Schedule Calculation" tab is active. It contains:

- Advanced Cursors:** Buttons for left/right arrows, a numeric input field (90.0), a zoom-in/out icon, and another numeric input field (0.10 NM).
- Operations:** Buttons for Reverse, Shift, Link, and Delete.
- Quick Distance Calculator:** From WPT: 0 (St-Petersburg), To WPT: 86 (Hamburg), Distance: 1398.25 NM.

To draw a new schedule, switch to **Schedule calculation** page.

The screenshot shows the "Schedule calculation" and "Schedule" panels. The "Schedule calculation" panel has a play button, a progress bar, and radio buttons for "Tidal currents" and "Surface currents". The "Schedule" panel has three buttons: "Create Schedule", "Clear Schedule", and "Delete Schedule".

Press **Create Schedule** button in **Schedule** group.

A close-up of the "Schedule" panel showing three buttons: "Create Schedule" (with a clock icon), "Clear Schedule" (with a clock icon), and "Delete Schedule" (with a trash can icon). The "Create Schedule" button is highlighted with a mouse cursor.

Enter the schedule elements for the WPT's to the table. To do this, perform the procedures detailed below:

- position the cursor on **ETA** element cell (not set for the route start point). Double click the left trackball/mouse button to activate the cell;
- enter ETA for this WPT and press the right trackball/mouse button;
- press **Apply** button to confirm the changes you have made;
- position the cursor on **Stay** element cell; double click the left trackball/mouse button to activate the cell;
- enter the time of stay at this WPT and press the right trackball/mouse button;
- press **Apply** button to confirm the changes you have made;
- position the cursor on **Time zone** element cell; double click the left trackball/mouse button to activate the cell;
- enter the time zone at this WPT and press the right trackball/mouse button;
- press “Apply” button to confirm the changes you have made;
- position the cursor on **ETD** element cell (not set for the route end point); double click the left trackball/mouse button to activate the cell;
- enter **ETD** for the WPT and press the right trackball/mouse button;
- press **Apply** button to confirm the changes you have made;
- position the cursor on **Speed** element cell; double click the left trackball/mouse button to activate the cell;
- enter the speed value on the route leg; press the left trackball/mouse button.

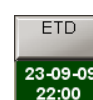
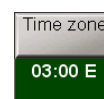
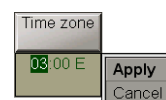
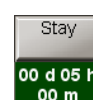
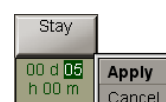
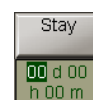
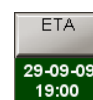

Note: There is no editing of TTG, Total Time or Average Speed cells.

When filling in the table you can use the context menu called by the right trackball/mouse button:

- **Clear cell** – to delete a value in the selected cell;
- **Fill cells down** – to fill in all the cells below with a value entered in the selected cell;
- **Fill cells up** – to fill in all the cells above with a value entered in the selected cell.

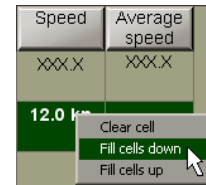

Attention! For the route start point, ETD value should always be specified. For the end point, it is necessary to specify ETA or speed of proceeding along the route legs.

In Schedule calculation group if necessary the current conditions to be taken into account in the schedule calculations, check Tidal currents and Surface currents checkboxes.

Press  button in Schedule Calculation group: the schedule will be calculated.

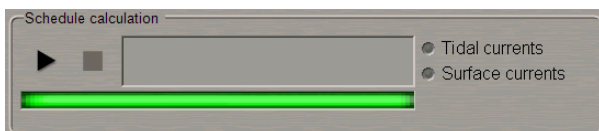

The schedule calculation process is reflected in the display window. In the table, empty cells will be filled in with the calculated schedule elements.

WPT	Name	ETA	Stay	Time zone	ETD	TTG	Total time	Speed	Average speed
0		XX-XX-XX XX:XX	XX-XX-XX XX:XX	03:00 E	04-10-12 22:00	XX-XX-XX	XX-XX-XX	XXX.X	XXX.X
1		04-10-12 19:03			04-10-12 19:03	00 d 00 h 03 m	00 d 00 h 03 m	12.0 kn	12.0 kn
2		04-10-12 19:05			04-10-12 19:05	00 d 00 h 02 m	00 d 00 h 05 m	12.0 kn	12.0 kn
3		04-10-12 19:10			04-10-12 19:10	00 d 00 h 04 m	00 d 00 h 10 m	12.0 kn	12.0 kn

A schedule has been created. To save the schedule, enter its name in the name input field of Schedule group.

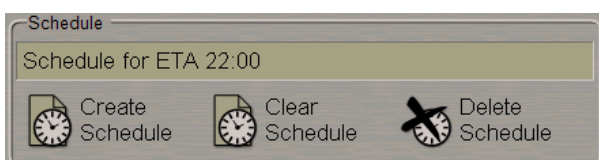

Press <Enter> button.

You can simultaneously create several schedules with different data for one and the same route. As a button with schedule name is pressed, the schedule becomes active and can be edited in the schedule Table. The active schedule can be selected in the string of **Schedule** group:

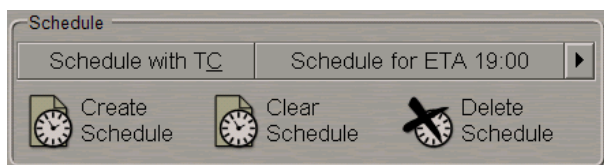

Editing a Schedule

Load the route for which the schedule will be drawn for (see paragraph *Work with Route, item Route Loading and Unloading*).

The display of the table is turned on/off by using the **Show tables** button.



In the left part of the **Route Planning** panel, press the button to display the corresponding table.



WPT	Name	ETA	Stay	Time zone	ETD	TTG	Total time	Speed	Average speed
0	St-Petersburg	XX-XX-XX XX:XX	XX-XX-XX XX:XX	03:00 E	24-09-12 22:00	XX-XX-XX	XX-XX-XX	XXX.X	XXX.X
1		24-09-12 22:01		03:00 E	24-09-12 22:01	00 d 00 h 01 m	00 d 00 h 01 m	12.0 kn	12.0 kn
2		24-09-12 22:03		03:00 E	24-09-12 22:03	00 d 00 h 02 m	00 d 00 h 03 m	12.0 kn	12.0 kn
3		24-09-12 22:06		03:00 E	24-09-12 22:06	00 d 00 h 02 m	00 d 00 h 06 m	12.0 kn	12.0 kn

Below the table, the 'Schedule calculation' section includes checkboxes for 'Tidal currents' and 'Surface currents'. The 'Schedule' group at the bottom right shows a dropdown menu with 'Schedule with TC' and 'Schedule 1125', and buttons for 'Create Schedule', 'Clear Schedule', and 'Delete Schedule'.

Switch to **Schedule calculation** page.

In the **Schedules** group, press the button with the name of the schedule which should be edited.

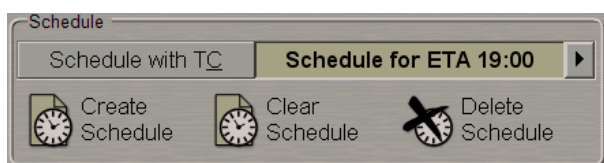

To edit schedule elements, perform the procedures detailed in previous section.



Attention! For the route start point, ETD value should always be specified. For the end point, it is necessary to specify ETA or speed of proceeding along the route legs.

In **Schedule calculation** group if necessary the current conditions to be taken into account in the schedule calculations, check/uncheck **Tidal currents** and **Surface currents** checkboxes.

To clear schedule table, press **Clear Schedule** button.

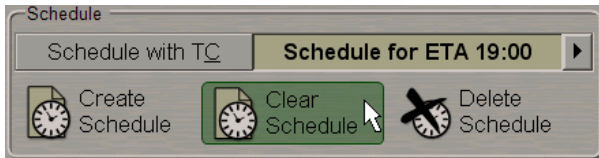

Create the schedule anew and save it as detailed in the previous section.

Deleting a Schedule

Load the route for which the schedule will be deleted (see paragraph *Work with Route*, item *Route Loading and Unloading*).

Press **Delete Schedule** button in **Schedule** group.

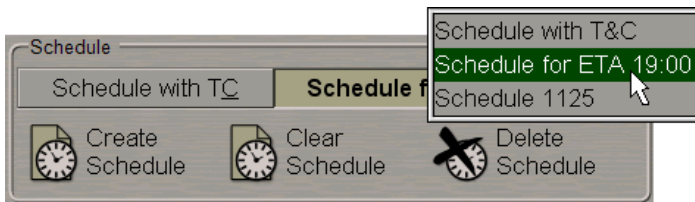

Select the schedule which should be deleted from the list, and press the left trackball button. In the window, which will appear, confirm the deleting.

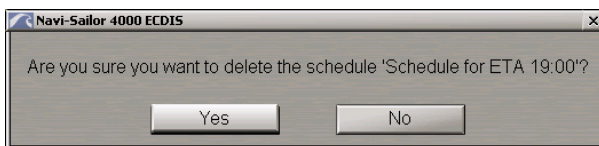

The schedule will be deleted.

Voyage Plan Creation

There is the possibility of automatic voyage creation using the chart extractions, UKC calculation, tides, currents and charts (crossed by the route) collection.

Load the route for which the schedule will be drawn for (see paragraph *Work with Route*, item *Route Loading and Unloading*).

Data Collection

The display of the table is turned on/off by using the **Show tables** button.

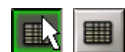

In the left part of the **Route Planning** panel, press the button to display the corresponding table.



WPT	Name	Remarks	Draught	Squat	UKC	Ref. Point	BRG/Dist
0	St-Petersburg		XXX.X	XXX.X	XXX.X		
1			10.0 m	0.8 m	Undefined		
2		Pilot on board	10.0 m	0.8 m	Undefined		
3			10.0 m	0.8 m	Undefined		

Edit Options | Anchor | Check Route | Schedule Calculation | Voyage plan | Protection control

Advanced Cursors: 90.0, 270.0, 0.10 NM, 99.9 NM
 Operations: Reverse, Shift, Link, Delete
 Quick Distance Calculator: From WPT: 0 (St-Petersburg), To WPT: 86 (Hamburg), Distance: 1398.25 NM

For input of the draught, perform the procedures detailed below:

- position the cursor on **Draught** element cell; double click the left trackball/mouse button to activate the cell;
- enter the draught value on the route leg; press the left trackball/mouse button;
- position the cursor on **Squat** element cell; double click the left trackball/mouse button to activate the cell;
- enter the squat value on the route leg; press the left trackball/mouse button.





To perform the automatic data collection, switch to **Voyage plan** page.

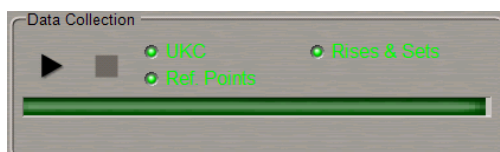

In the **Data Collection** group, check checkboxes of those data categories which should be included in the Voyage Plan.



Press  button in **Data Collection** group: the selected data will be collected.

If necessary to interrupt manually the data collection, press  button.

After the data collection, the voyage plan data will be available in the Extra data table.

WPT	Name	Remarks	Draught	Squat	UKC	Ref. Point	BRG/Dist
50			9.5 m	0.8 m	9.7 m		
51			9.5 m	0.8 m	Shallow water	Light house	143.5° 3.17 NN
52			9.5 m	0.8 m	19.7 m	Light house	010.7° 1.41 NN
53	Pilot buoy		9.5 m	0.8 m	9.7 m	Light house	170.7°

Obtaining Information on Sun/Moon on the Route

For this functionality to operate it is necessary that a schedule be drawn for the route and that during the voyage plan creating the **Rises&Sets** checkbox be checked (see the previous paragraph).

After the voyage plan has been created, the Chart panel will show the route with symbols of the sunrise/sunset and moonrise/moonset.

Note: To this end, it is necessary to turn on the display of these symbols in the **Show** drop-down list in the top part of the **Route Planning** panel (see section *Work with Route*, paragraph *Creating a Route*, item *Entering Additional Data*).

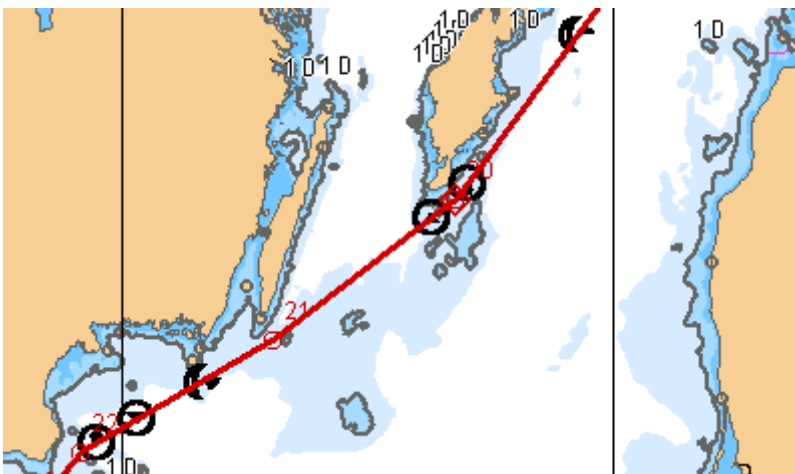

Position the free View cursor on the necessary symbol; the cursor will change its form. Press the left trackball button: the data card will display the calculated data: sunrise/sunset and moonrise/moonset, coordinates, date of passing this point on the route.

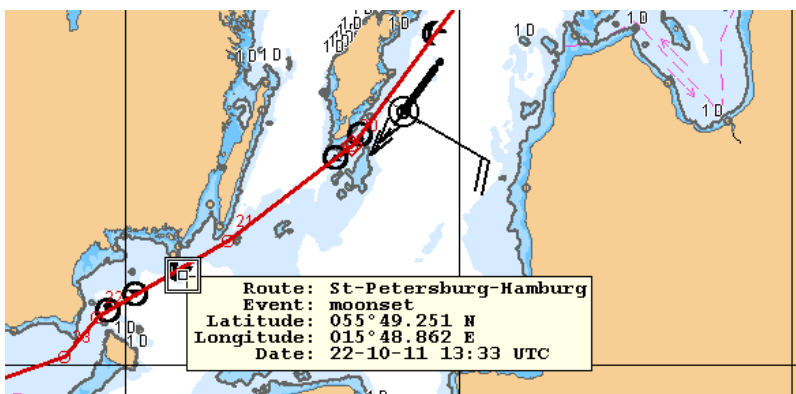

Voyage Plan Data Edition

The display of the table is turned on/off by using the **Show tables** button.



In the left part of the **Route Planning** panel, press the button to display the corresponding table.



WPT	Name	Remarks	Draught	Squat	UKC	Ref. Point	BRG/Dist
0	St-Petersburg		XXX.X	XXX.X	XXX.X		
1			10.0 m	0.8 m	Shallow water	Light house	007.7° 1.38 NM
2		Pilot on board	10.0 m	0.8 m	Shallow water	Light house	021.4° 1.67 NM
?			10.0 m	0.8 m	Shallow	Light house	034.5°

The Extra data table contains the following data (columns) on reference points:

- **Ref. point** – reference point name taken from the chart object (if the object has no name, the cell is empty);
- **BRG/Dist** – bearing and distance to the reference point.

Reference points are set automatically during the data collection, if **Ref. points** checkbox is checked in **Data Collection** group of **Voyage plan** page (see previous item).

Setting and Changing Reference Points

To set or change a reference point, position the cursor on the necessary WPT in the Extra data table and click the left trackball/mouse button on the required point.

WPT	Name	Remarks	Draught	Squat	UKC	Ref. Point	BRG/Dist
24			6.0 m	0.8 m	8.2 m	Light house	192.8° 6.51 NM
25			6.0 m	0.8 m	5.2 m	Light house	255.1° 10.44 NM
26			6.0 m	0.8 m	6.1 m	Light house	329.8° 3.44 NM
27			6.0 m	0.8 m	8.5 m	Light house	002.8°

To set reference points on the Chart Panel, press **Ref.pts.** button in the top part of the **Route Planning** panel.

An acquisition marker will appear on the Chart Panel at the selected WPT.

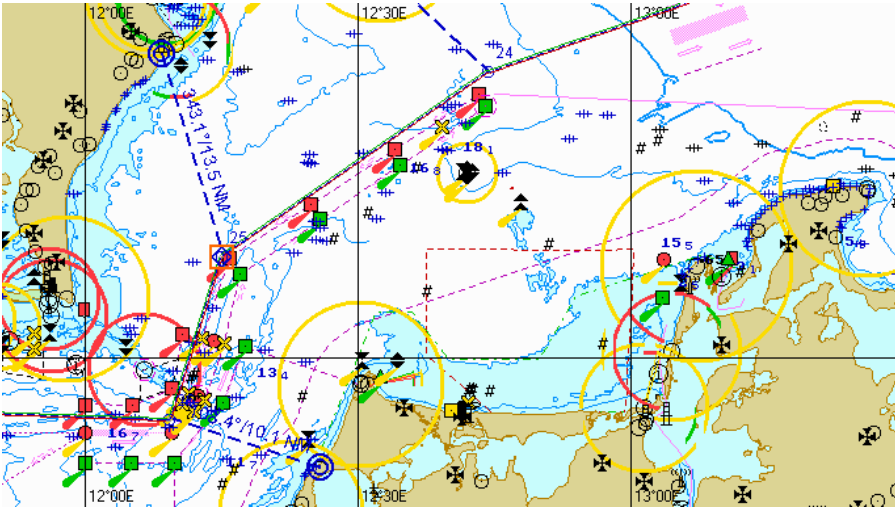

The right-hand part of the screen will display the **Select waypoint** information window showing the acquisition marker coordinates and bearing/distance relative to the WPT WOL.

Select waypoint	
Latitude	54°36.494' N
Longitude	012°14.903' E
Bearing	059.1 °
Opp. Bearing	239.1 °
Range	1134.76 NM

Press Tab to edit manually

Press the left trackball/mouse button: the marker will acquire the WPT and change own form. Position the marker in the new reference point within the displayed Chart Panel.

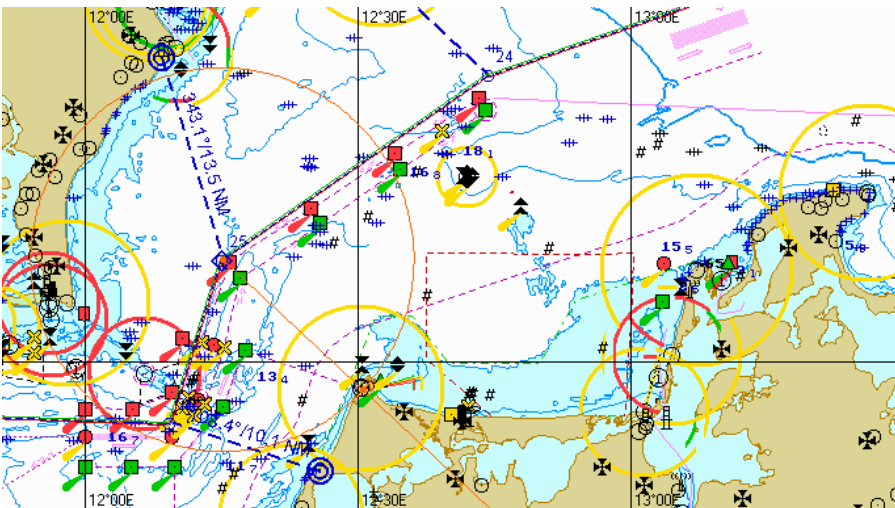

The **Select waypoint** information window showing the acquisition marker coordinates and bearing/distance relative to the WPT WOL.

Select waypoint

Latitude 1

Longitude 1

Bearing °

Opp. Bearing °

Range NM

Latitude 2

Longitude 2

Press Tab to edit manually

Press the left trackball/mouse button.

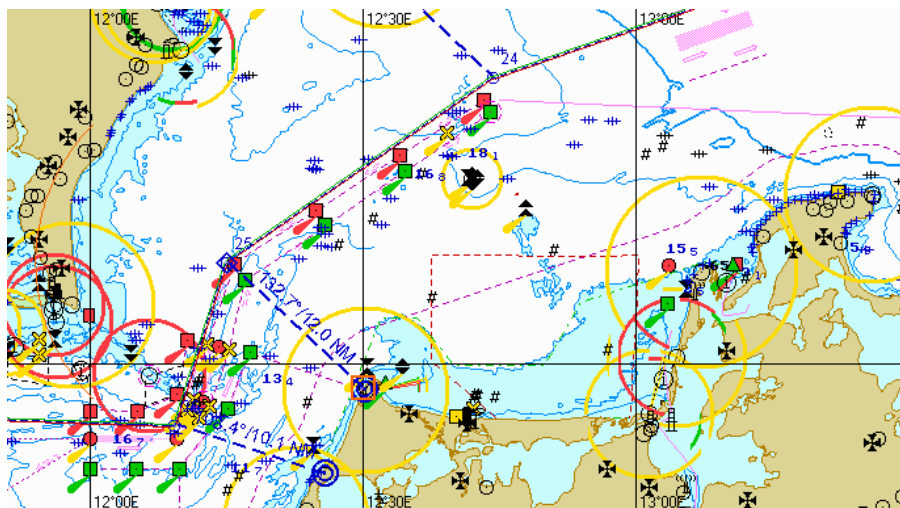

The reference point will be shown on the Chart Panel in the form of two blue circles. The blue dashed line connects the WPT WOL and its corresponding reference point.

The values of bearing/distance to the reference point from the WPT WOL are shown over the line.

The same values are displayed in the table's **BRG/Dist** column.

WPT	Name	Remarks	Draught	Squat	UKC	Ref. Point	BRG/Dist
24			6.0 m	0.8 m	8.2 m	Light house	192.8° 6.51 NM
25			6.0 m	0.8 m	5.2 m	Light house	133.0° 11.98 NM
26			6.0 m	0.8 m	6.1 m	Light house	329.8° 3.44 NM
27			6.0 m	0.8 m	8.5 m	Light house	002.8°

Press the right trackball/mouse button to exit from the editing mode. The marker will assume the shape of the free cursor.

Deleting Reference Points

To delete a reference point, position the cursor on the necessary WPT in the Extra data table and press the left trackball/mouse button.

WPT	Name	Remarks	Draught	Squat	UKC	Ref. Point	BRG/Dis
24			6.0 m	0.8 m	8.2 m	Light house	192.8° 6.51 NM
25			6.0 m	0.8 m	5.2 m	Light house	255.1° 10.44 NM
26			6.0 m	0.8 m	6.1 m	Light house	329.8° 3.44 NM
27			6.0 m	0.8 m	8.5 m	Light house	002.8°

To set reference points on the Chart Panel, press **Ref.pts.** button in the top part of **Route Planning** panel.



An acquisition marker will appear on the Chart Panel at the selected WPT.

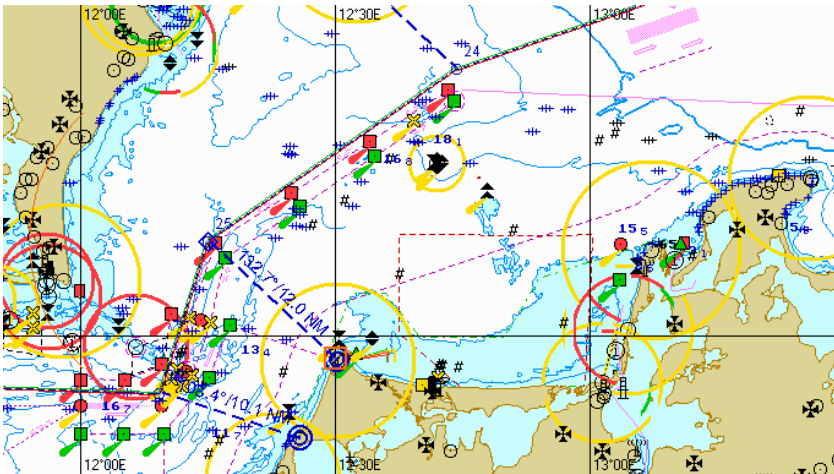

Press the left trackball/mouse button: the marker will acquire the WPT and change own form. Press the right trackball/mouse button: the reference point has been deleted.

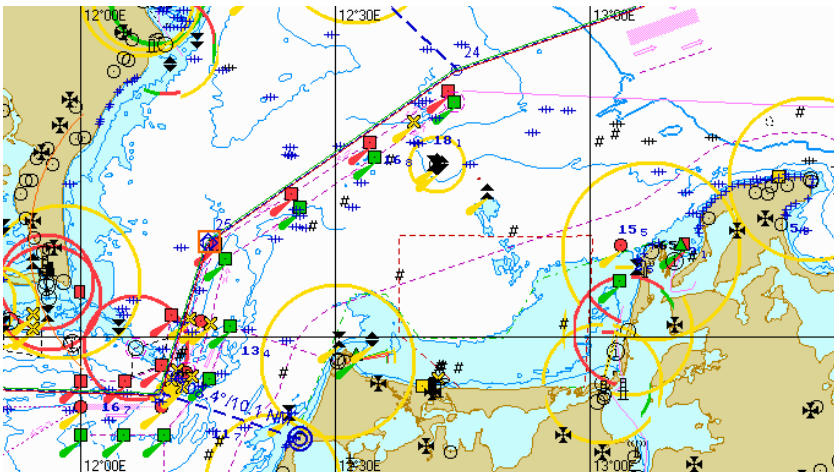

Press the right trackball/mouse button to exit from the editing mode. The marker will assume the shape of the free cursor.

Search for Reference Point

To view a reference point on the Chart Panel, position the cursor on the necessary WPT in the Extra data table and press the left trackball/mouse button.

WPT	Name	Remarks	Draught	Squat	UKC	Ref. Point	BRG/Dist
24			6.0 m	0.8 m	8.2 m	Light house	192.8° 6.51 NM
25			6.0 m	0.8 m	5.2 m	Light house	255.1° 10.44 NM
26			6.0 m	0.8 m	6.1 m	Light house	329.8° 3.44 NM
27			6.0 m	0.8 m	8.5 m	Light house	002.8°

Reference point is displayed in the centre of the Chart Panel:

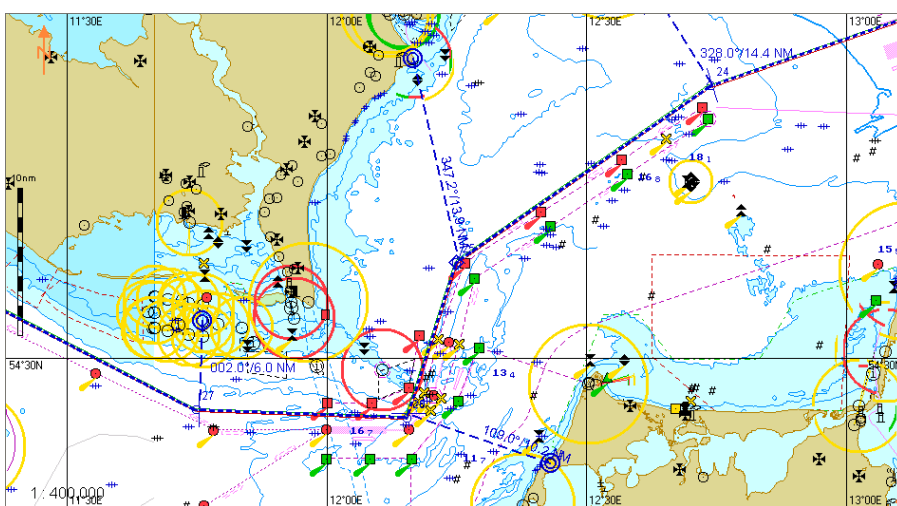

Voyage Plan Print Preview and Printing

Load the route, which should be printed (see paragraph *Work with Route*, item *Route Loading and Unloading*).

Create Voyage plan (see *Voyage Plan Creation* paragraph).

Switch to **Voyage plan** page.



Press **Preview** button in **Print** group.

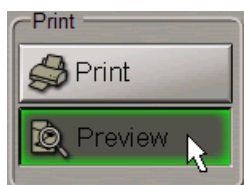

The **Print Preview** window will display a printed version of the Voyage Plan.

Print Preview

Page 1 of 16

Voyage No.: Ship's Name: KOLA FROM: TO: Master's Name:

WAYPOINTS										
WPT	Name	Position	Leg	Total distance	XTD port/stbd	Turnradius	Draught	UKC	Masthead	Overhead clearance
0	St-Petersburg	59°53.835 N 030°13.243 E	XXXXX XXXXX	XXXXX	XXXXX	XXXXX	XXXXX	XXXXX	XXXXX	XXXXX
1		59°53.262 N 030°12.754 E	216.5° 0.20 NM	0.20 NM	0.01 NM	0.30 NM	10.0 m	Shallow water	Undefined	Undefined
2		59°53.281 N 030°11.957 E	288.4° 0.49 NM	0.70 NM	0.01 NM	0.30 NM	10.0 m	Shallow water	Undefined	Undefined
3		59°53.119 N 030°10.756 E	255.0° 0.56 NM	1.26 NM	0.01 NM	0.30 NM	10.0 m	Shallow water	Undefined	Undefined
4		59°56.852 N 029°52.510 E	292.2° 10.01 NM	11.27 NM	0.01 NM	0.30 NM	10.0 m	Shallow water	Undefined	Undefined
5	Pilot buoy	59°57.756 N 029°47.762 E	280.8° 2.50 NM	13.77 NM	0.01 NM	0.30 NM	10.0 m	Shallow water	Undefined	Undefined
6		59°58.846 N 029°45.408 E	312.7° 1.60 NM	15.36 NM	0.01 NM	0.30 NM	10.0 m	Shallow water	Undefined	Undefined
7		59°59.094 N 029°43.732 E	286.5° 0.93 NM	16.29 NM	0.01 NM	0.30 NM	10.0 m	Shallow water	Undefined	Undefined
8		59°59.306 N 029°40.950 E	278.8° 1.41 NM	17.70 NM	0.01 NM	0.30 NM	10.0 m	Shallow water	Undefined	Undefined
9		60°01.736 N 029°25.785 E	287.7° 7.88 NM	25.68 NM	0.01 NM	0.30 NM	10.0 m	Shallow water	Undefined	Undefined
10		60°03.242 N 028°31.410 E	273.2° 27.27 NM	52.95 NM	0.01 NM	0.30 NM	10.0 m	Shallow water	Undefined	Undefined
11		60°07.832 N 028°16.433 E	301.5° 8.83 NM	61.78 NM	0.01 NM	0.30 NM	10.0 m	Shallow water	Undefined	Undefined
12		60°12.302 N 027°46.312 E	288.1° 16.09 NM	77.89 NM	0.01 NM	0.30 NM	10.0 m	Shallow water	Undefined	Undefined
13		59°56.828 N 027°02.751 E	239.2° 24.83 NM	102.71 NM	0.01 NM	0.30 NM	10.0 m	Shallow water	Undefined	Undefined
14		59°56.861 N 026°52.897 E	273.0° 4.99 NM	107.69 NM	0.01 NM	0.30 NM	10.0 m	10.0 m	Undefined	Undefined
15		60°03.238 N 026°40.948 E	297.0° 7.19 NM	114.88 NM	0.01 NM	0.30 NM	10.0 m	Shallow water	Undefined	Undefined
16		59°47.940 N 024°41.208 E	255.8° 61.84 NM	176.71 NM	0.01 NM	0.30 NM	10.0 m	Shallow water	Undefined	Undefined
17		59°45.150 N 024°12.811 E	259.0° 14.72 NM	191.44 NM	0.01 NM	0.30 NM	10.0 m	Shallow water	Undefined	Undefined
18		59°30.197 N 022°28.825 E	254.1° 64.69 NM	246.13 NM	0.01 NM	0.30 NM	10.0 m	Shallow water	Undefined	Undefined
19		59°08.228 N 021°32.243 E	230.4° 37.73 NM	283.86 NM	0.01 NM	0.30 NM	10.0 m	10.0 m	Undefined	Undefined
20		58°50.508 N 018°23.220 E	216.5° 169.20 NM	483.06 NM	0.01 NM	0.30 NM	10.0 m	Shallow water	Undefined	Undefined

Printed: 10/09/12 19:42:22 Prepared by nav. Officer: Checked by Master: Page 1

For the preview of the Voyage Plan pages, use the following buttons:

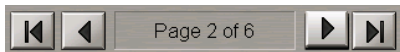

Attention! Check that the printer is connected to the computer on which the NS4000 is installed.

Press **Print** button in **Print** group.



The voyage plan will be printed.

Exporting Voyage Plan

Load the route, which should be converted to any formats listed below (see paragraph *Work with Route, Route Loading and Unloading* item).

Switch to **Voyage plan** page.



Press appropriate button in **Export** group.

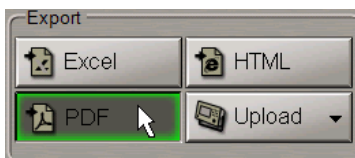
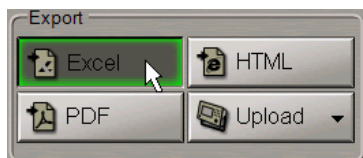

Voyage plan will be exported.

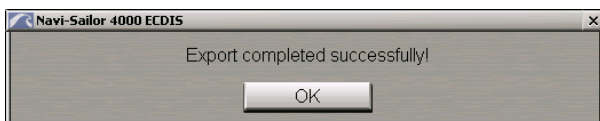

Press **OK** button.

Access to the file is by using the Data Tool utility, in the **Route** group of **Route export** feature.

Chapter 10.

Handling Radar Information and Target Designation Units

This chapter describes the procedure used in the handling of radar information and target designation units.

<u>Radar Overlay</u>	328
Work with Radar Overlay	328
Distance and Bearing Offset	331
<u>ARPA</u>	333
Target Display	333
Turning On/Off External ARPA Tools	335
ARPA Settings	336
<u>AIS</u>	342
Handling AIS Targets	342
Setting of Voyage Data	345
Transmission of Messages in AIS System	348
Reception of Messages in AIS System	351
Using AIS Safety Messages Database	354
<u>Handling Targets</u>	355
Setting of Safety Parameters in the Tracking of Targets	355
Handling Target Table	356
Prompt Target Search	357
Turning On Mode of Associating AIS and ARPA Targets	359
Turning On DR Mode for AIS Targets	360
Filtering Lost Targets	362
Filtering AIS Targets	363
Obtaining Information on Target	365

Radar Overlay

Work with Radar Overlay

To select a scanner, press the scanner selection button arrow in the **Sensors** window of the Control panel.



Select the necessary scanner (the button name corresponds to the selected scanner).

To turn on the radar picture, press **Overlay** button.



A radar picture will appear on the Chart panel.

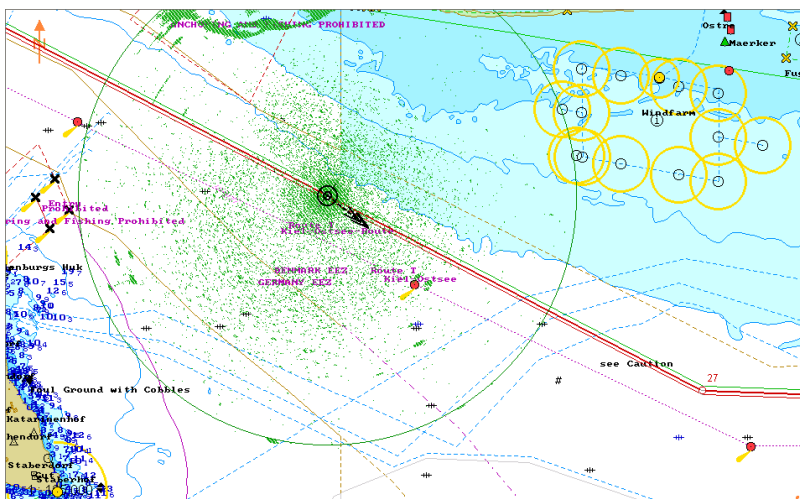

Press the button with the name of the set display in the **Display Panel** window of the Control panel.

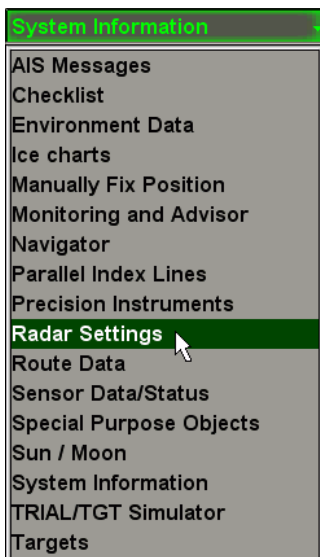

In the list, which will open up, select **Radar Settings** line and press the left trackball button.

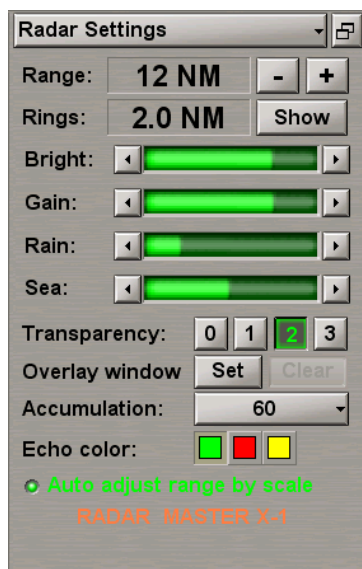

In **Radar Settings** display which will open up, set the range scale. To do this, use the buttons to the right of Range input window.



Turn on display of range rings as required. To do this, press **Show** button to the right of Rings window.



Set the required brightness, gain, suppression of rain and sea clutter by using the buttons on the sides of level indicators.



To enter the required “transparency” value, use the buttons (from 0 – opaque to 3 – almost transparent) in Transparency group.

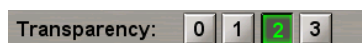

To set the required rectangular area of the radar picture display, press **Set** button in **Overlay window** group.



A graphic cursor will appear in the chart screen area. Position the cursor in the initial point of the area and press the left trackball button. Set the required radar picture area by moving the cursor, keeping the left trackball button depressed.

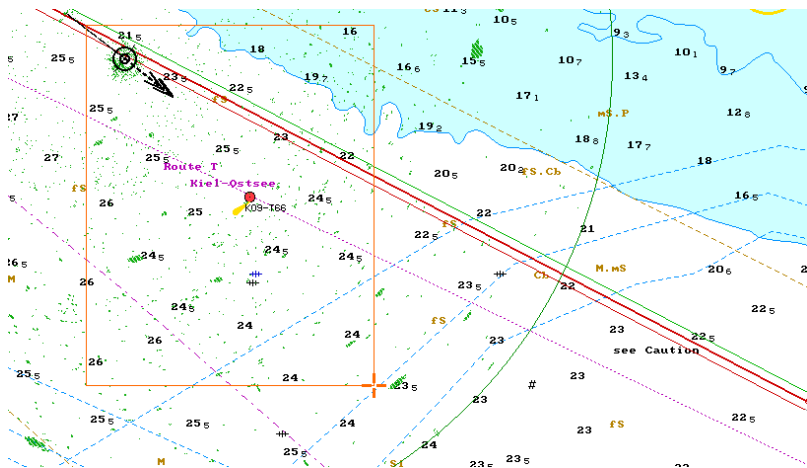

Press the trackball button again. The area will be set.

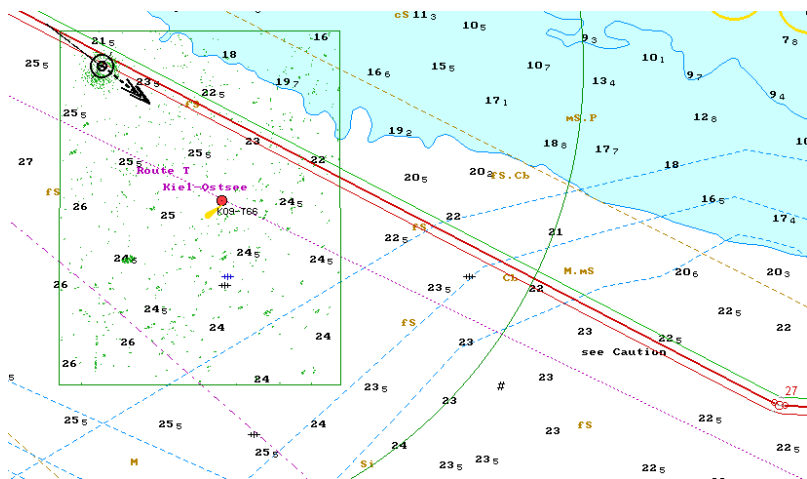

Turn on and adjust the scan-to-scan correlation function as required. To do this, press the button in Accumulation group.

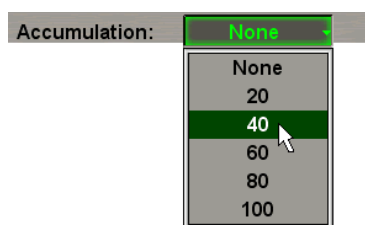

In the list, which will open up, select the necessary value (from 20 to 100) or **None** to switch the function off. Press the left trackball button to confirm selection.

Press the required colour button in Echo colour button group to set the colour of the radar picture.



Check the **Auto adjust range by scale** checkbox if it is necessary, to automatically switch the scanner scale with a switch of the ECDIS task screen scale.



The adjustment of the radar picture is completed.

RADAR MASTER X-1

RADAR MASTER X-1 - status of selected radar picture source (see above) on this WS (see document *Multi-Functional Display (v. 3.00.340). Functional Description, Chapter 10, section Network Configuration, paragraph Interswitch*).

Distance and Bearing Offset



Attention! Distance and Bearing Offset is only made on the WS with RADAR MASTER status.

Introduction

Adjustment of the RIB in azimuth, i.e. an offset to the fixed azimuth errors of the radar antenna. The magnitude of the offset is determined as the difference between the bearing value of a clearly observed and uniquely identified stationary radar object measured on the chart or by using other measurement method, and a mean value of several bearing measurements made for the same object by using the RIB. The offset corresponds to the value of an angle, which the picture should be turned to in the clockwise direction for it to match the actual situation. The offset is entered with an accuracy of up to one tenth of a degree.

Adjustment of the RIB in range, i.e. an offset to the delays in the radar and RIB circuits. The magnitude of the offset is determined by comparing the results of range measurements made for clearly observed and uniquely identified stationary radar objects by using the RIB radar picture, and measurements made on the chart or by using other methods. The offset is entered with an accuracy of up to 1 m.

Distance and Bearing Offset Setting

Open **Config** panel by selecting the appropriate line of **Tasks List** menu in the tabs zone of the ECDIS task screen.

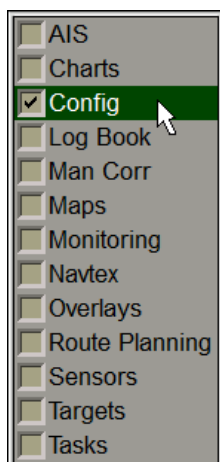

Use the tab in the top part of **Config** panel, which will open up, to switch to **Radar settings** page.

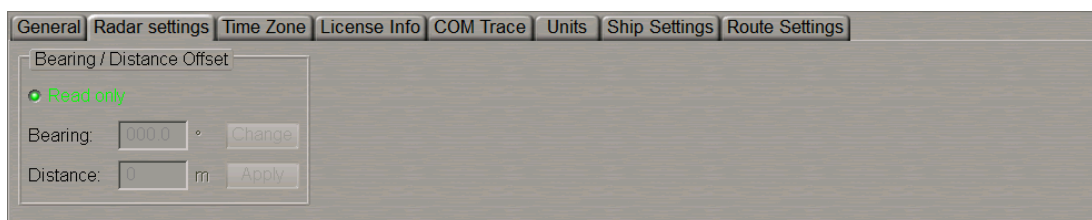

Uncheck Read only checkbox and enter a password:



Press **OK**.

Press **Change** button.

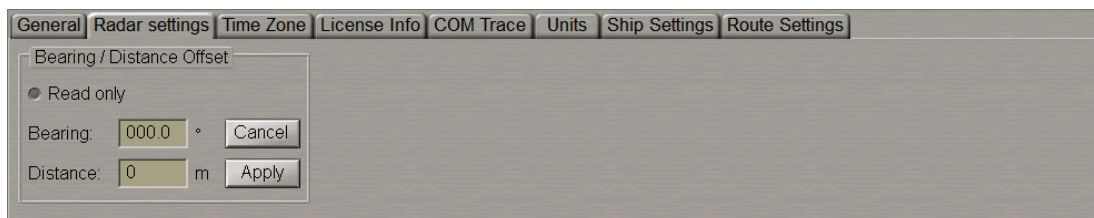

Use EBL 1 to measure the bearing to the electronic chart object used for the adjustment purposes. Use EBL 2 to measure the bearing to the echo of the object used for the adjustment purposes.

Calculate the Bearing Offset value as the difference between the EBL 1 and EBL 2 readouts, and enter it in **Bearing** box.

Use VRM1 to measure the distance to the electronic chart object used for the adjustment purposes. Use VRM2 to measure the distance to the echo of the object used for the adjustment purposes. Calculate the Distance Offset value as the difference between the VRM1 and VRM2 readouts, and enter it in **Distance** box.

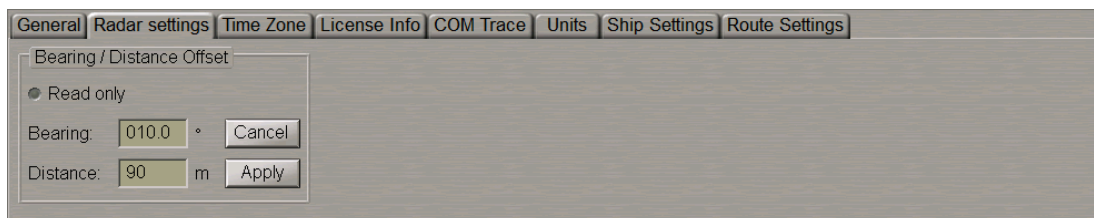

Press **Apply** button.

Make several iterations as required, achieving the maximum possible alignment of the radar picture and chart information.



Attention! In making the adjustment, use the differential positioning mode in order to obtain the required accuracy.

The adjustment is made by using the radar observed conspicuous features whose polar coordinates are known with accuracy not inferior to 0.1° in azimuth and 2 m in range.

ARPA

Target Display

There are three ways to turn on/off the display of ARPA targets on the ECDIS task screen:

1. Open **Targets** panel by selecting the appropriate line of **Tasks List** menu in the tabs zone of the ECDIS task screen.

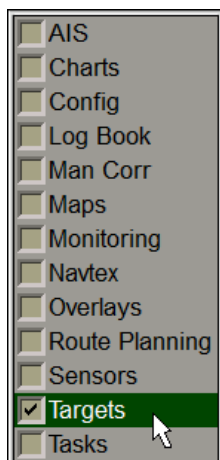

Use the tab in the top part of **Targets** panel, which will open up, to switch to **Target Table** page:

Name	40	41	42	43	44	37	47	48	49	50	51	52	53	54
Alias														
CPA (NM)	2.88	5.87	7.32	6.81	7.74	5.81	4.09	4.53	5.86	8.23	1.25	6.76	8.07	5.62
TCPA (min)	-9.7	-8.4	-6.9	-14.5	-9.3	-21.2	-21.2	-21.2	10.4	12.8	21.8	-16.4	-16.6	-19.2
SOG (kn)	45.3	43.5	29.4	26.8	33.1	11.3	15.0	13.1	22.4	12.3	16.8	19.5	15.8	12.8
COG (°)	14.5°	295.9°	65.7°	287.1°	281.1°	30.0°	5.9°	36.4°	84.2°	170.7°	81.6°	348.7°	358.2°	29.6°
Range (NM)	8.94	8.33	8.43	9.10	9.05	8.79	8.67	8.57	7.63	8.46	8.44	9.59	10.11	8.56
Bearing (°)	359.3°	350.7°	0.3°	351.7°	352.5°	352.7°	45.2°	5.8°	203.4°	236.6°	257.5°	317.5°	318.4°	352.4°
Bow X (NM)	7.7	-5.9	-20.9	-6.9	-8.1	55.4	-10.5	112.1	10.6	8.2	-2.6	11.1	16.8	49.3
TBow X (min)	-17.9	-9.0	25.4	-16.5	-13.8	-197.9	5.6	-346.8	-8.4	15.6	27.7	-37.6	-56.9	-164.8

In **Show Target** group press the following button:

- **ARPA A(B)** – to turn on the display of ARPA A(B) targets. Connection is made in the System Configuration utility (see document *Multi-Functional Display (v. 3.00.340). Installation Guide Part I, Chapter 2*, section *MFD Configuration*, paragraph *Sensors Settings*);
- **Own** – to turn on the display of ARPA targets processes by the ARPA built into the program.

- In the **Sensors** window of the Control panel select the necessary source of ARPA targets and press **ARPA** button. From the drop-down list select the necessary ARPA source.

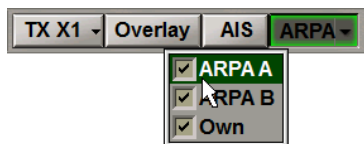

- Press the <Target> key on the ES6 keyboard (the display of all the ARPA targets from all the available sources is turned on).

If there are some ARPA tracked targets, they will appear on the Chart panel, whereas their motion parameters will be shown in the target table.

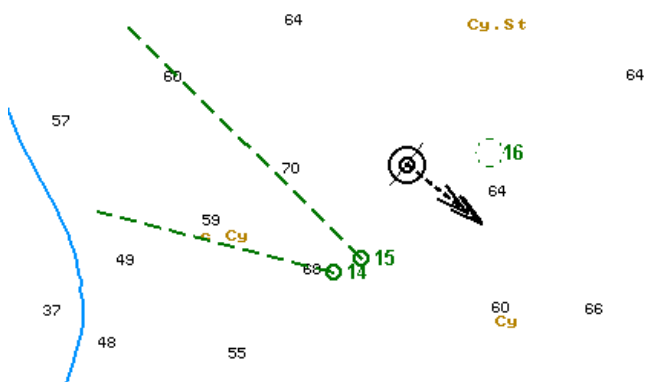

Turn on, as required, the display of target tracks. To do this, press **Tracks** button in **Show Target** group.



Target tracks will be displayed on the Chart panel.

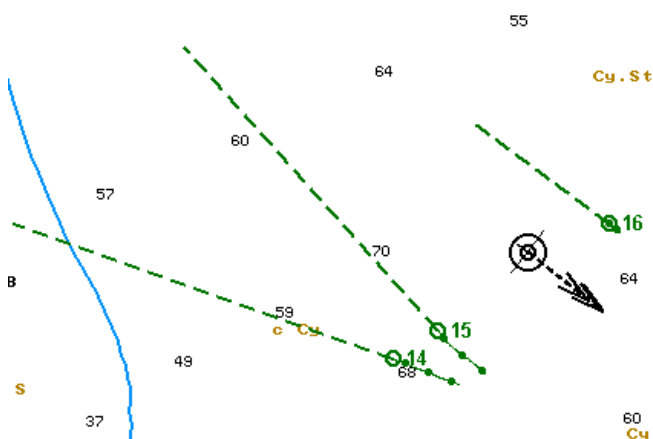

Turning On/Off External ARPA Tools



Attention! The tools are not available unless the external ARPA-A are connected and provides relevant sentences.

Open **Targets** panel by selecting the appropriate line of **Tasks List** menu in the tabs zone of the ECDIS task screen.

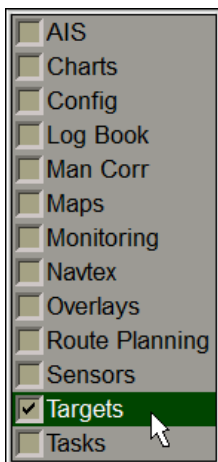

Use the tab in the top part of **Targets** panel, which will open up, to switch to **Target Table** page:

Target Table | AIS color tracks

Show Target: **ARPA A** | Own | AIS | Tracks | ARPA B | Cursors | ERBL

AIS Target identification: By ID

Max. range: 48 nm

Alarm: CPA: 1.00 NM, TCPA: 1.0 min

Name	A2	T001
Alias		
CPA (NM)	1.90	3.24
TCPA (min)	XXXX	-59.2
SOG (kn)	12.0	9.0
COG (°)	216.5°	210.0°
Range (NM)	2.39	4.54
Bearing (°)	228.1°	100.4°
Bow X (NM)	XXXX	10.2
TBow X (min)	XXXX	-240.2

In **Show Target** group of **Targets** panel, which will open up, press **ARPA A** button.

To turn on the display of tools on the Chart panel, press the **Cursors** and/or **ERBL** buttons in the **Show Target** group.

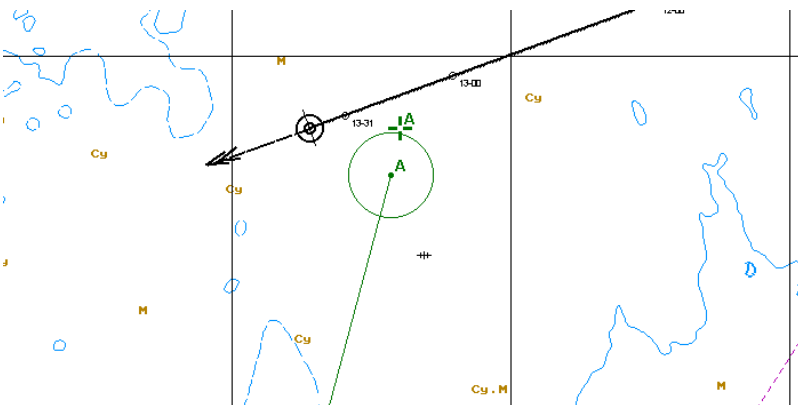

ARPA Settings

To turn on the display of targets, press **Overlay** and **ARPA** button in the **Sensors** window of the Control panel.



Press the button with the name of the set display in the **Display Panel** window of the Control panel.

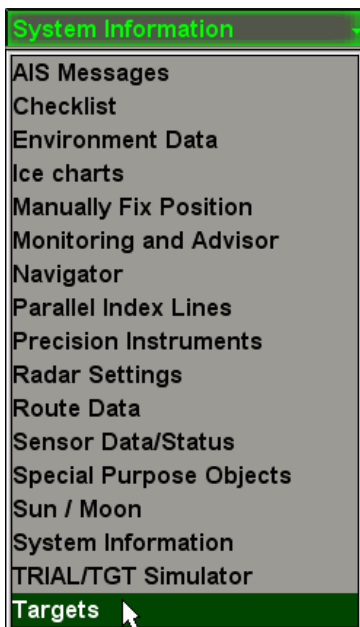

In the list, which will open up, select **Targets** line and press the left trackball button.

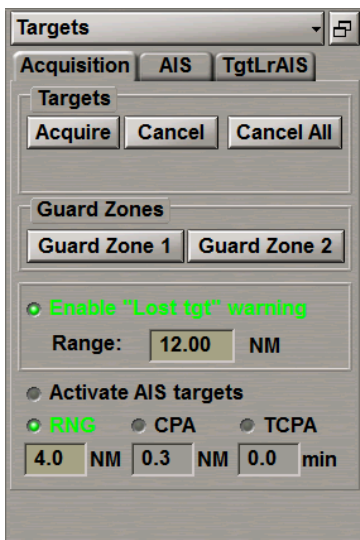

To Acquire Targets for Tracking

To switch the cursor to target acquisition mode, press **Acquire** button in **Targets** group.



Position the cursor on the target and press the left trackball button.

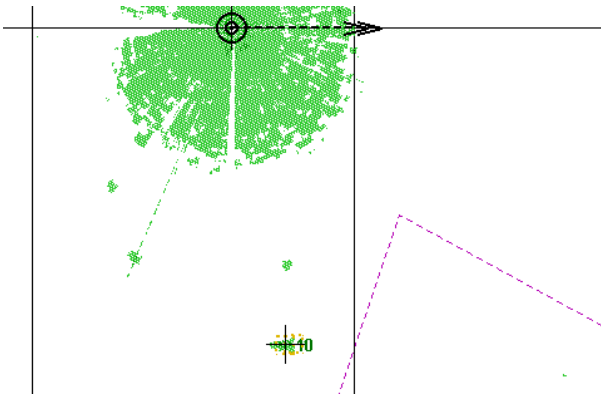

In a minute, the acquired target will be displayed as a green coloured circle with pre-calculated motion vector.

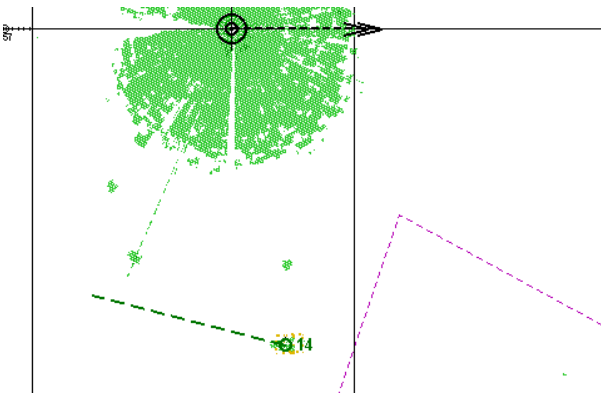

The target has been acquired for tracking. If you press the right trackball button, the cursor exits from the target acquisition mode.

To Cancel Tracked Targets

To switch the cursor to the target tracking cancelling mode, press **Cancel** button in **Targets** group.



Position the cursor on the tracked target and press the left trackball button.

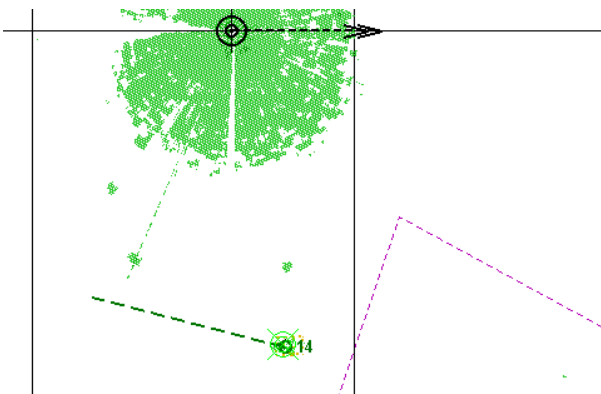

The target tracking will be cancelled.

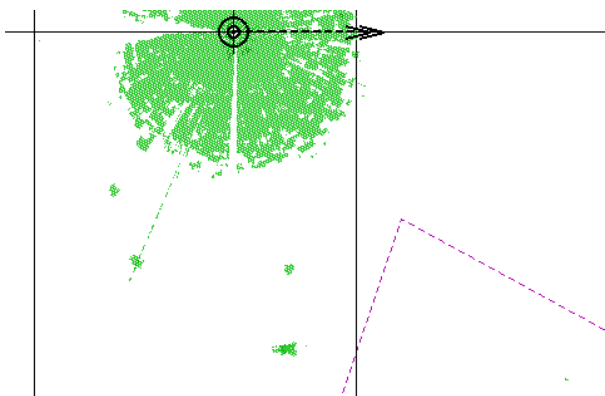

If you press the right trackball button, the cursor exits from the tracking cancelling mode.

To cancel tracking of all the previously acquired targets, press **Cancel All** button in **Targets** group.

To Turn on Ring Shaped Guard Zones

To set the Guard Zone manually, press **Guard Zone 1** or **Guard Zone 2** buttons.



The ring shaped guard zone will be displayed on the ECDIS task screen. Targets getting within the guard zone will be displayed in the form of flickering circles.

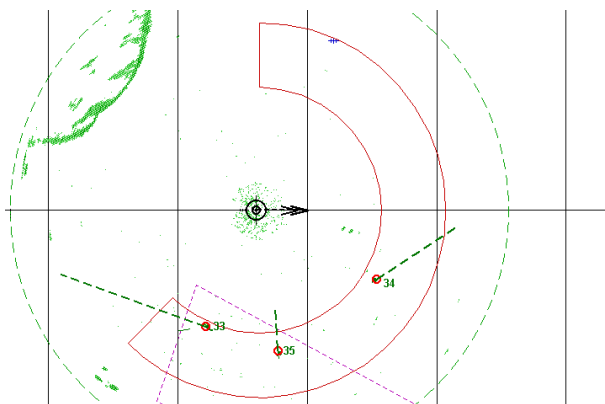

At the same time, **GZ Tgt ID** warning will be triggered off. Acknowledge this warning. After the processing, targets will be displayed in the form of yellow coloured circles with pre-calculated motion vectors.

To Set Guard Zone Limits

To set guard zone limits, position the free cursor on the left-hand boundary of the guard zone. As this is done, the cursor will assume the following form: 

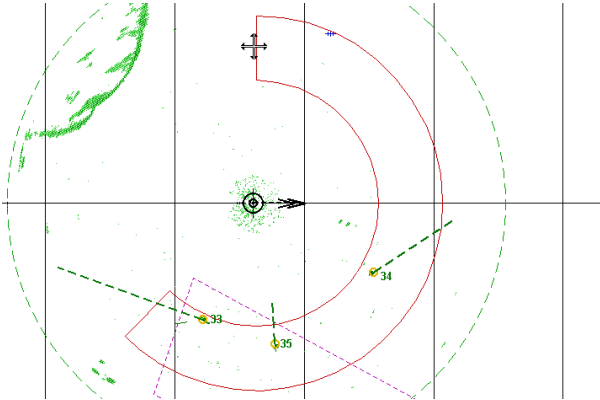

Press the left trackball button. The cursor will assume the form of a graphic cursor.

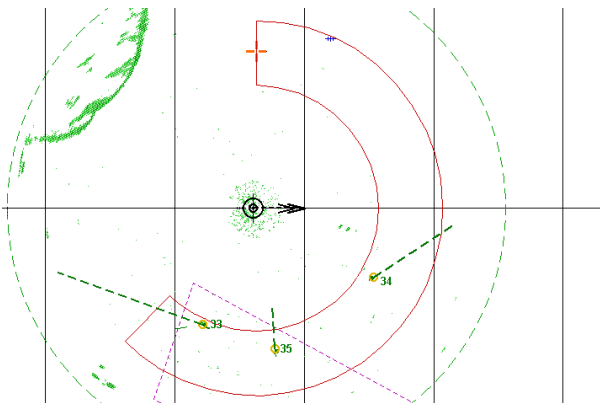

Move the ring shaped zone along the circle relative to the own ship symbol in the required direction.

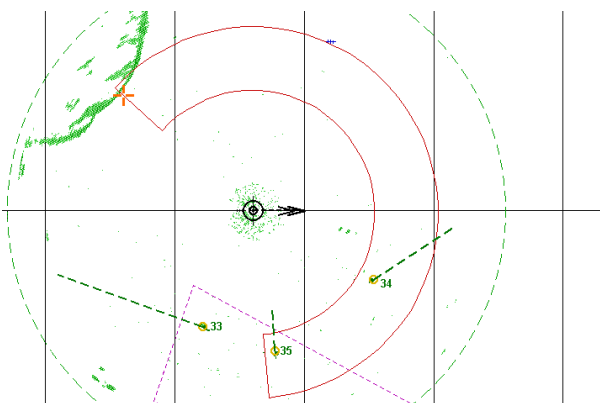

Press the left trackball button to set the new position of the zone and to exit from the graphic cursor mode. Position the free cursor on the right-hand boundary of the guard zone.

As this is done, the cursor will assume the following form: 

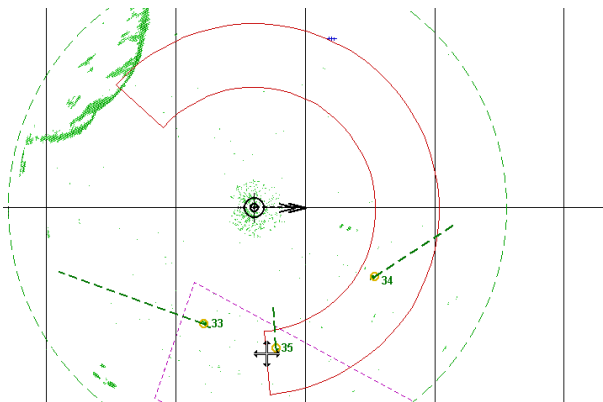

Press the left trackball button. The cursor will assume the form of a graphic cursor.

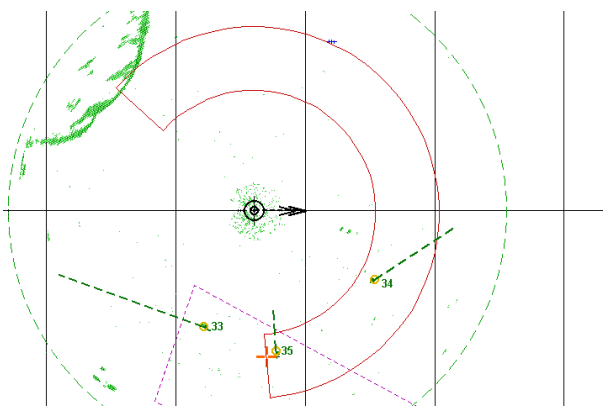

Move the right-hand limit of the ring shaped zone setting the necessary coverage angle.

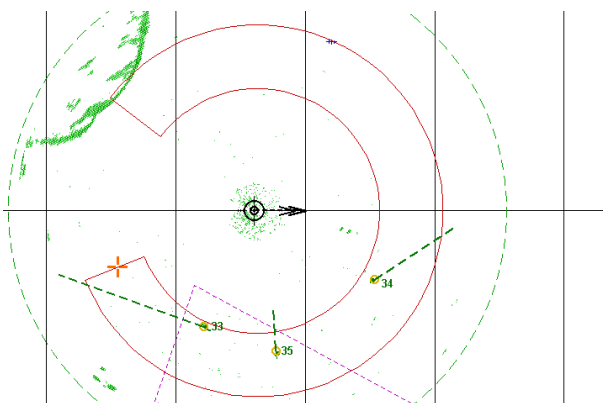

Press the left trackball button to set the new position of the zone and to exit from the graphic cursor mode. Position the free cursor on one of the arcs delimiting the guard zone.

As this is done, the cursor will assume the following form: 

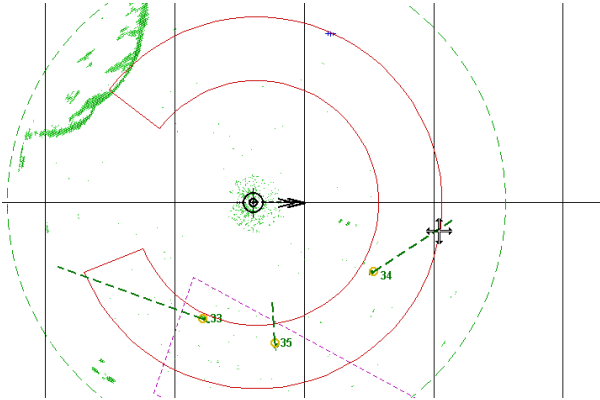

Press the left trackball button. The cursor will assume the form of a graphic cursor.

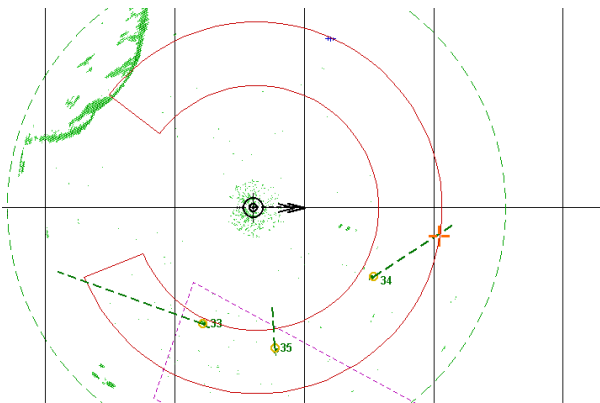

Move the zone limit to the required distance.

Note: If the zone's closer limit crosses its farther limit in the process of zone shift, they exchange their places.

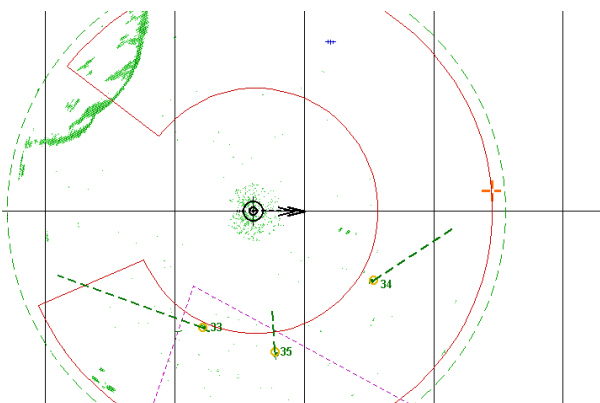

Press the left trackball button to set the new zone position and exit from the graphic cursor mode.

To Turn Off Guard Zones

To turn off a guard zone, release the appropriate button.

AIS

Handling AIS Targets

AIS Target Display

There are three ways to turn on/off the display of AIS targets on the ECDIS task screen:

1. Open **Targets** panel by selecting the appropriate line of **Tasks List** menu in the tabs zone of the ECDIS task screen.

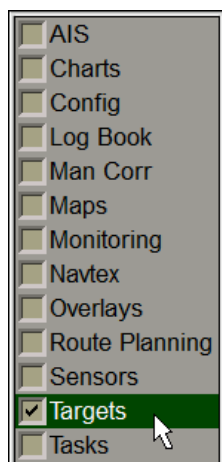

Use the tab in the top part of **Targets** panel, which will open up, to switch to **Target Table** page:

The screenshot shows the 'Target Table' panel with the following controls and data:

Show Target: ARPA, Own, AIS, Tracks, ARPA B, Cursors, ERBL

AIS Target identification: By ID

Alarm: CPA 1.00 NM, TCPA 1.0 min

Max. range: 48 nm

Name	40	41	42	43	44	37	47	48	49	50	51	52	53	54
Alias														
CPA (NM)	2.88	5.87	7.32	6.81	7.74	5.81	4.09	4.53	5.86	8.23	1.25	6.76	8.07	5.62
TCPA (min)	-9.7	-8.4	-6.9	-14.5	-9.3	-21.2	-21.2	-21.2	10.4	12.8	21.8	-16.4	-16.6	-19.2
SOG (kn)	45.3	43.5	29.4	26.8	33.1	11.3	15.0	13.1	22.4	12.3	16.8	19.5	15.8	12.8
COG (°)	14.5°	295.9°	65.7°	287.1°	281.1°	30.0°	5.9°	36.4°	84.2°	170.7°	81.6°	348.7°	358.2°	29.6°
Range (NM)	8.94	8.33	8.43	9.10	9.05	8.79	8.67	8.57	7.63	8.46	8.44	9.59	10.11	8.56
Bearing (°)	359.3°	350.7°	0.3°	351.7°	352.5°	352.7°	45.2°	5.8°	203.4°	236.6°	257.5°	317.5°	318.4°	352.4°
Bow X (NM)	7.7	-5.9	-20.9	-6.9	-8.1	55.4	-10.5	112.1	10.6	8.2	-2.6	11.1	16.8	49.3
TBow X (min)	-17.9	-9.0	25.4	-16.5	-13.8	-197.9	5.6	-346.8	-8.4	15.6	27.7	-37.6	-56.9	-164.8

In **Show Target** group press **AIS** button.

2. Press **AIS** button in the **Sensors** window of the Control panel.

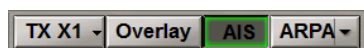

3. Press <Target> key on the ES6 keyboard.

AIS targets will appear in the Chart panel, and their motion parameters will be displayed in the Targets Table.

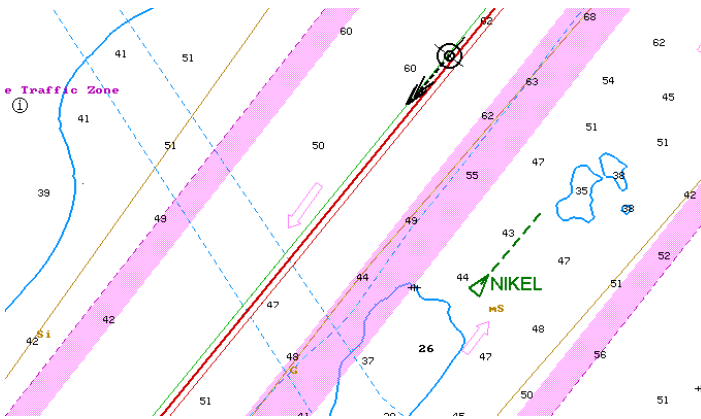

By default in **Max. Range** input box set the value 48 nm, that is the radius of an area within which the AIS targets are processed and displayed.

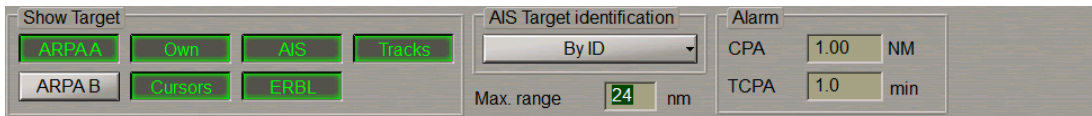

Set the necessary radius (up to 100 NM) of processing AIS targets area.

Display of AIS Target Identifiers

Press **AIS Target identification** button to select the AIS targets identifier.

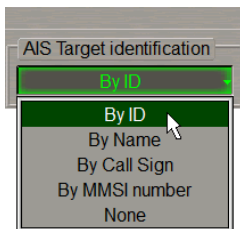

In the list, which will open up, select the necessary identifier or **None** to declutter the Chart panel. Press the left trackball button. Targets will be displayed on the Chart panel with the selected identifier, and its name will be shown on the button.

Position the cursor on the target identifier in the Targets Table.

Name	000316044	ALGOVILLE	316001696
Alias			
CPA (NM)	3.6	2.6	32.5
TCPA (min)	-545.5	9.5	-259.1
COG (°)	0.0°	163.8°	79.0°
SOG (kn)	0.0	9.1	4.6
Range (NM)	45.52	4.00	45.27
Bearing (°)	164.5°	19.8°	167.4°
Bow X (NM)	XXXX	2.4	-52.2
TBow X (min)	XXXX	29.2	76.6

The hint will display the name of the AIS object if it is contained in the messages transmitted by the AIS object.

Enter as required identifier “Alias” (up to 8 characters) for an AIS object in **Alias** row of the Targets Table.

Name	A2	273002414	671641000
Alias		Fellow	
CPA (NM)	1.90	3.24	1.95
TCPA (min)	XXXX	-79.8	XXXX

On the Chart panel, the target will be displayed with the entered “Alias” identifier regardless of settings made in **AIS Target identification** group. This identifier is displayed on the Chart panel only and is not transmitted in messages.

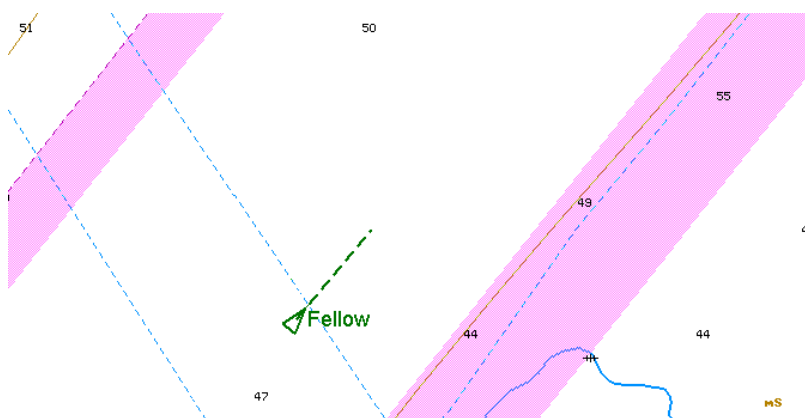

Display of Target Tracks

Turn on, as required, the display of target tracks. To do this, press **Tracks** button in **Show Target** group.



Target tracks will be displayed on the Chart panel.

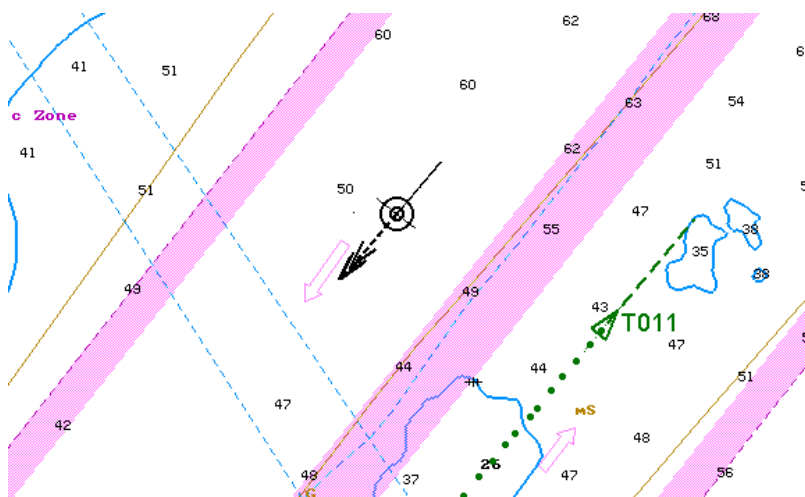

Prompt Target Search

Press the button with the target identifier in Name line of the Targets Table, e.g. 316001696.

Name
273002414
316001696
671641000

The selected target will be displayed in the centre of the Chart panel highlighted with a flashing circle.

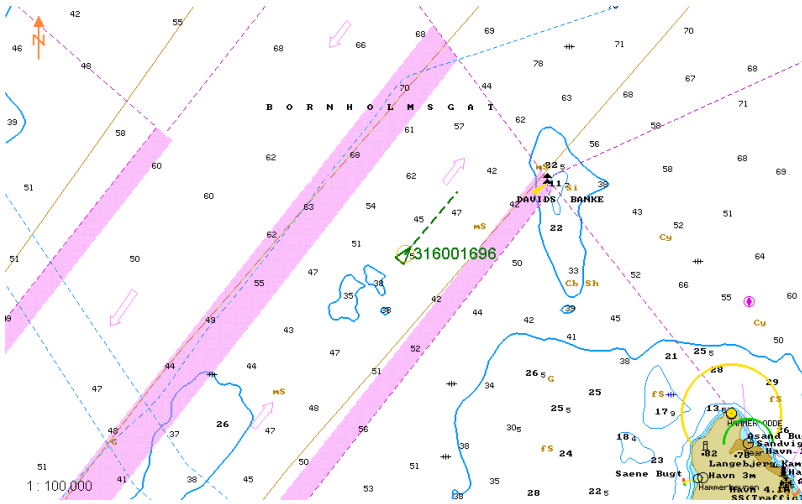

Setting of Voyage Data



Attention! Setting of voyage data is available only at station with the status MASTER.

Open **AIS** panel by selecting the appropriate line of **Tasks List** menu in the tabs zone of the ECDIS task screen.

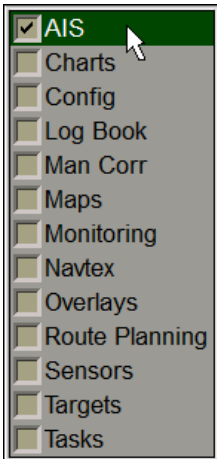

Use the tab in the top left part of AIS panel to switch to **Voyage and Static Data** page. Press Edit button.

If the AIS class B is selected during the installation (see document *Multi-Functional Display (v. 3.00.340). Installation Guide Part 1, Chapter 2, section MFD Configuration, paragraph Sensors Settings*) the AIS panel looks like follows:

Note: In this case, the set of possible settings is limited.

In the left-hand part of **Voyage and Static Data** page, press Navigational status button.

In the list, which will open up, select the own ship navigation status and press the left trackball button.

Press **Type of ship** button in the left-hand part of the page.

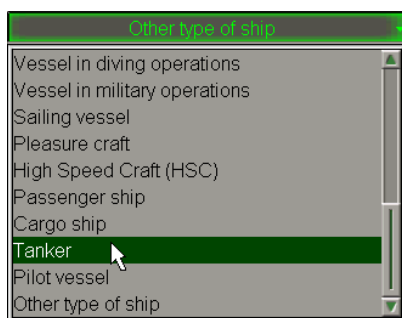

In the list, which will open up, select the own ship type and press the left trackball button.

Press **Cargo** button in the left-hand part of the page (for ships carrying cargoes only).

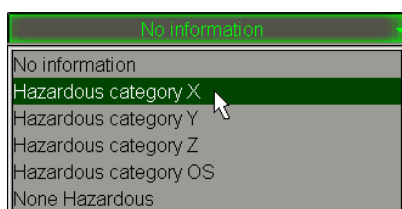

In the list, which will open up, select the dangerous cargo category as required and press the left trackball button.

Use **Mean draught** input line to enter the own ship mean draught value and press the left trackball button.



Use **Destination** input line to enter the own ship port of destination (not more than 20 symbols) and press the left trackball button.



Use **ETA** line to enter the ETA (UTC) in the port of destination specified in **Destination** line, and press <Enter> key. If the system (UTC) time value is larger than the entered ETA value, "Undefined" will be automatically set in ETA input line.



In **Persons on board** input line, enter the number of persons on board and press the left trackball button.

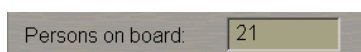

Press **Apply** button.



Attention! Static Data group always displays own ship data, which is set on **Ship settings** page of **INS** panel of the System Configuration utility and cannot be changed in the ECDIS task. Where the transponder settings do not match those in the ECDIS task, the own ship name and Call Sign are shown in orange colour.

Static Data:	<input type="button" value="Restore"/>
Name:	KOLA
Call Sign:	UCKB
MMSI:	273130500
IMO Number:	008013053

As other devices are connected to the AIS transponder in addition to the MFD (e.g. MKD or pilot software), the own ship name and call sign in the transponder can be changed by these users. The operator is notified about these changes by **Check AIS Ship Name** and **Check AIS Call Sign** cautions, which will remain active until the own ship data is restored in the transponder. To restore the own ship data settings in the transponder as per the settings in the System Configuration utility, press **Restore** button.

The setting of own ship parameters transmitted in the AIS system is completed.

Transmission of Messages in AIS System

Turn on the display of AIS targets (see paragraph *Handling AIS Targets*).

Open **AIS** panel by selecting the appropriate line of **Tasks List** menu in the tabs zone of the ECDIS task screen.

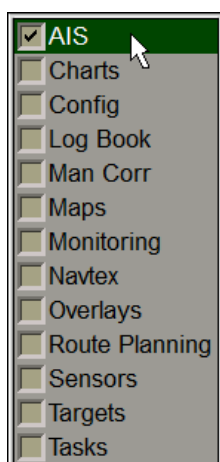

Use the tab in the left-hand part of **AIS** panel to switch to **Messaging** page.

Voyage and Static Data					Messaging					IMO special messages					Interrogation					Long Range					Channel Management				
Send message																													
Create Message																													
N	Sent to	Date/Time (UTC)	Type	Status																									
3	316001696	20-04-2006 10:04:49	Safety Text	Waiting																									
2	273002413	20-04-2006 10:04:27	Safety Text	Delivered																									
1	ALL	20-04-2006 10:01:43	Safety Text	Sent																									
Receive message																													
From: 273002413					THE RACON ON LIGHTBUOY TANGO-1																								
To: All stations					IN PSN 5747 2 N 01046.1 E IS																								
Type: Safety text					INOPERATIVE																								
<input checked="" type="radio"/> AIS message notification <input checked="" type="radio"/> Show new message																													
Reply					Request Route					Show Sender					⏪					⏩									

To prepare and transmit a text message, press **Create Message** button on **Messaging** page in **Send message** group and select **Safety Text**.

Note: If the AIS class B is selected during the installation, the capability to send messages with the "Safety Text" and/or "Normal Text" status is set in the System Configuration utility. (see *Multi-Functional Display (v. 3.00.340)*, *Installation Guide Part I, Chapter 2, section MFD Configuration*, paragraph *Sensors Settings*).



Press the left trackball button. **Send Message** window will open up, specifying the type of the selected message.

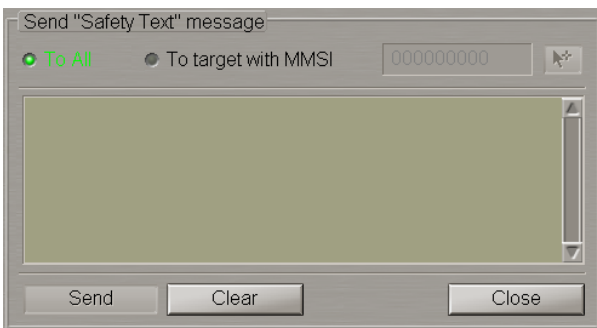

Set the identifier of the addressee of the message to be sent. To transmit a message to all the ships in the radio coverage area, check **To All** checkbox.



To transmit a message to a certain ship, use one of the three procedures:

1. Check **To target with MMSI** checkbox and enter the MMSI of the addressee in the input line which will be activated.



2. Check **To target with MMSI** checkbox and press  button to the right of the input line. Position the acquisition marker, which will appear on the Chart panel, on the target, which is the addressee of the message.

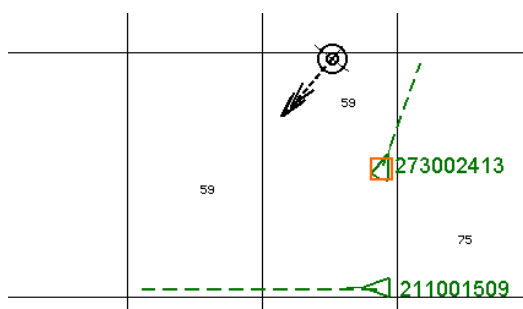

Press the left trackball button. The input line will display the MMSI of the specified target.



3. To send a reply message, press **Reply** button in **Receive Message** group.

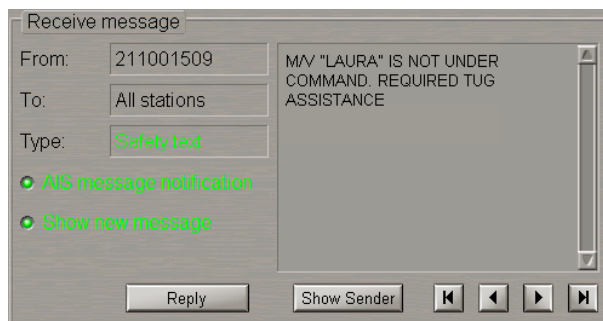

With the use of **Reply** function, **Send message** window opens up for a message, which has the same type as the message received from an AIS object, "Safety Text" in this case. The input line will automatically display MMSI of the AIS object, which the message has been received from.



Use the text input window in **Send Message** group to enter the text of the message, which should be sent.

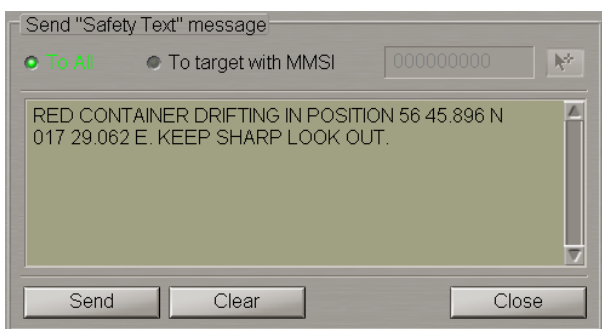

Press **Send** button.

The NS 4100, provided the SAAB R4 transponder is used and the relevant option is available, has a capability to transmit messages via the protected channel.

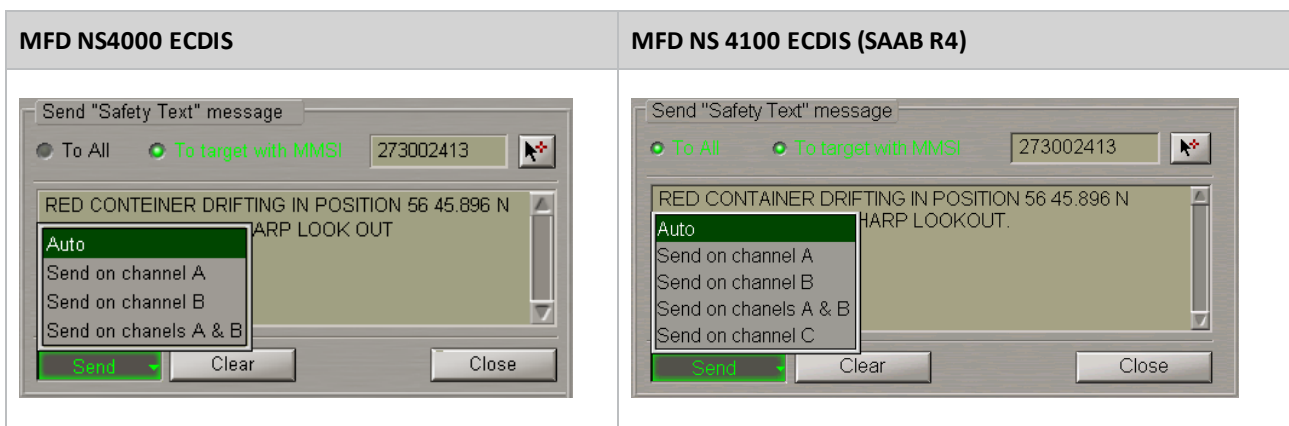

In this case, the following messages are displayed when the respective channel is selected:

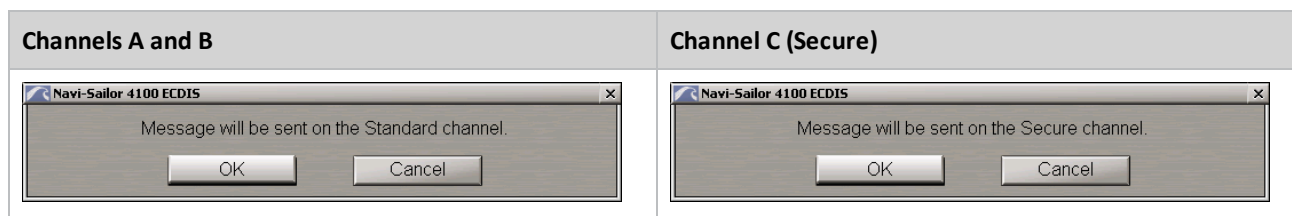

Select the message despatch channel (**Auto** is generally recommended). The compiled message will be sent. Press **Close** button.

Check the sent message status in the table in **Send message** group. The message status may be one of the following:

- **Waiting** – the message has been transmitted by the MFD, but no confirmation of its relay has been received from the transponder;
- **Sent** – the message has been sent by the transponder, but no confirmation of its delivery to the addressee has been received or confirmation is not expected if the message was sent to all the AIS objects (“All” identifier);
- **Delivered** – the message has been delivered to the addressee;
- **Failed** – the message, for some reasons, cannot be sent by the transponder.

The text of sent “Safety Text” messages, as well as their status (except “Waiting”) is recorded in the ship’s electronic logbook.

Reception of Messages in AIS System



Attention! The default setting implies generation of **AIS message** notification upon the receipt of messages from AIS objects.

As the notification is accepted by the operator, the received messages is shown on **AIS Messages** display of the Control panel and in **Receive message** group on **Messaging** page of **AIS** panel.

Press the button with the name of the set display in the **Display Panel** window of the Control panel.

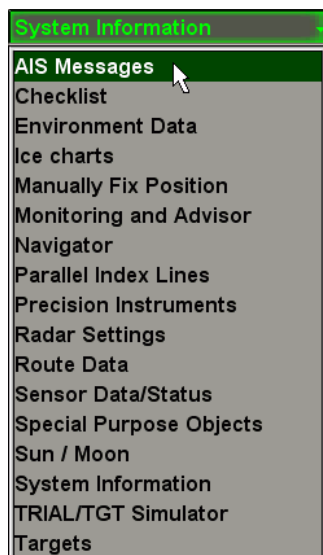

In the list, which will open up, select **AIS Messages** line and press the left trackball button.

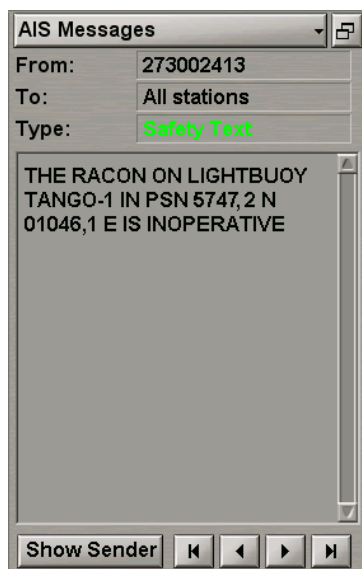

In **AIS Messages** display, which will open up, read the received message. Use  buttons to view the received messages.



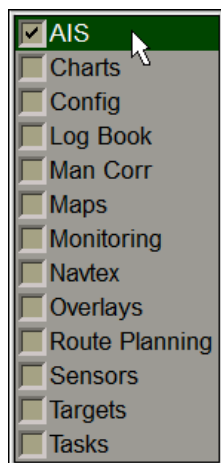

Attention! Control buttons in **AIS Messages** display of the Control panel and in **Receive Message** group on **Messaging** page of **AIS** panel are synchronised.

Open **AIS** panel by selecting the appropriate line of **Tasks List** menu in the tabs zone of the ECDIS task screen.

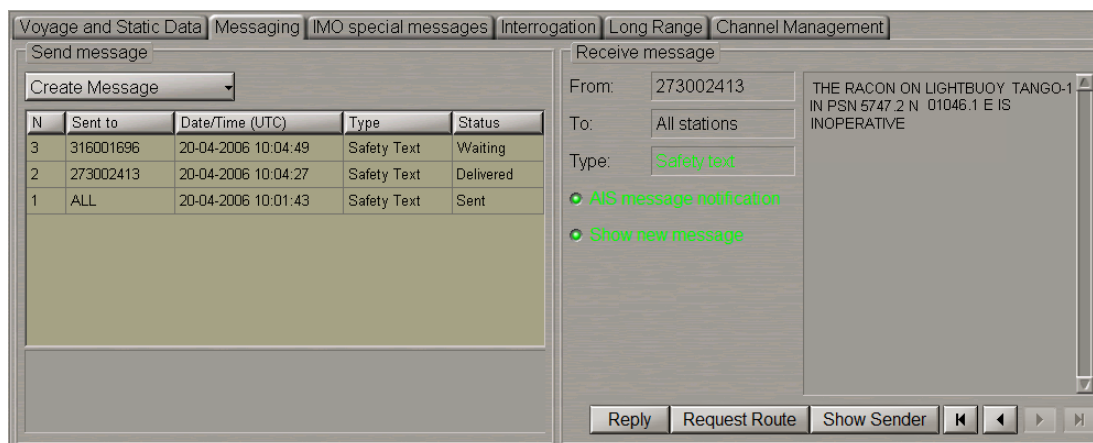

Use the tab in the left-hand part of AIS panel to switch to **Messaging** page.



In **Receive message** group, read the received message. Use   buttons to view the received messages.

AIS message checkbox is checked by default, arrival of a message, therefore, triggers off **AIS Message** notification. Uncheck this checkbox to disable the notification generation upon the receipt of AIS messages.

Show new message checkbox is checked by default; upon the receipt of a new message it will, therefore, be shown in **AIS Messages** display of the Control panel and in **Receive** group on **Messaging** page of AIS panel. Uncheck this **Show new message** checkbox to save an image of the viewed message upon the receipt of a new message.

Turn on the display of AIS targets (see paragraph *Handling AIS Targets*). AIS targets will appear on the Chart panel.

To display the message sender target, press **Show Sender** button.

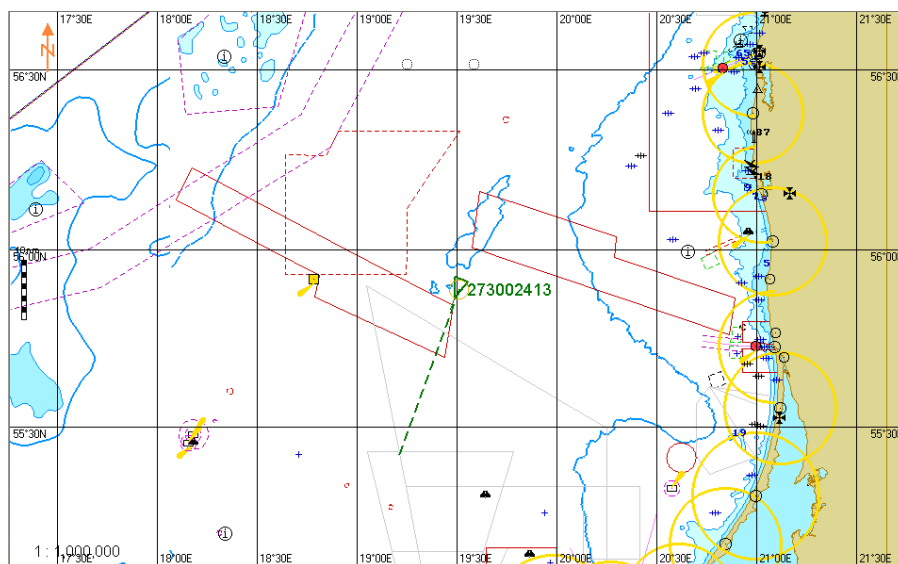

The target will be shown in the centre of the Chart panel, highlighted with a flashing circle.

Using AIS Safety Messages Database

Open **AIS** panel by selecting the appropriate line of **Tasks List** menu in the tabs zone of the ECDIS task screen.

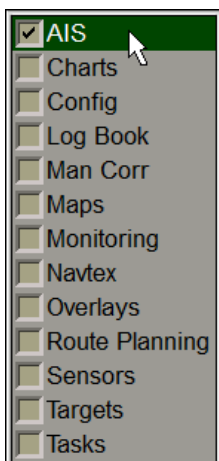

Use the tab in the left-hand part of **AIS** panel to switch to **Safety Messages DB** page.

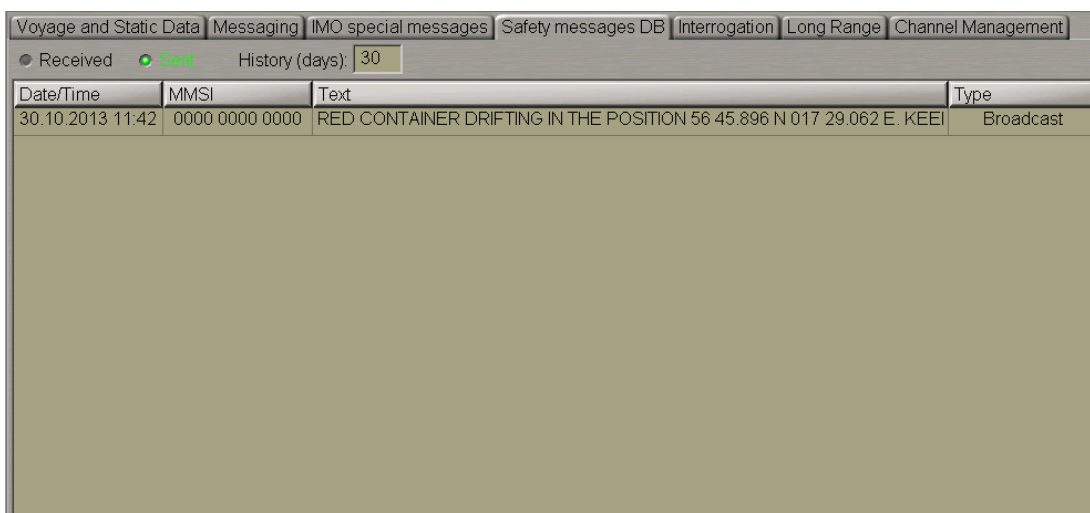

The **Safety Messages DB** page is intended for displaying database-stored AIS messages with the "Safety" status over a certain time interval. The page includes the following items:

- **Received** – to turn on the display of received messages in the table;
- **Sent** - to turn on the display of sent messages in the table;
- **History** – time interval over which messages from the database are displayed (from 1 to 30 days);
- **Messages table** which contains the following columns:
 - **Data/Time** – message receive/send time and date;
 - **MMSI** – addressee's MMSI;
 - **Text** – text of the message;
 - **Type** – message sending method (Broadcast/Addressed).

Use the **Received** / **Sent** radio buttons to select the type of messages to be displayed in the table.

In the **History** input window set the necessary time interval.

To display full text of the message, position the cursor on this message.

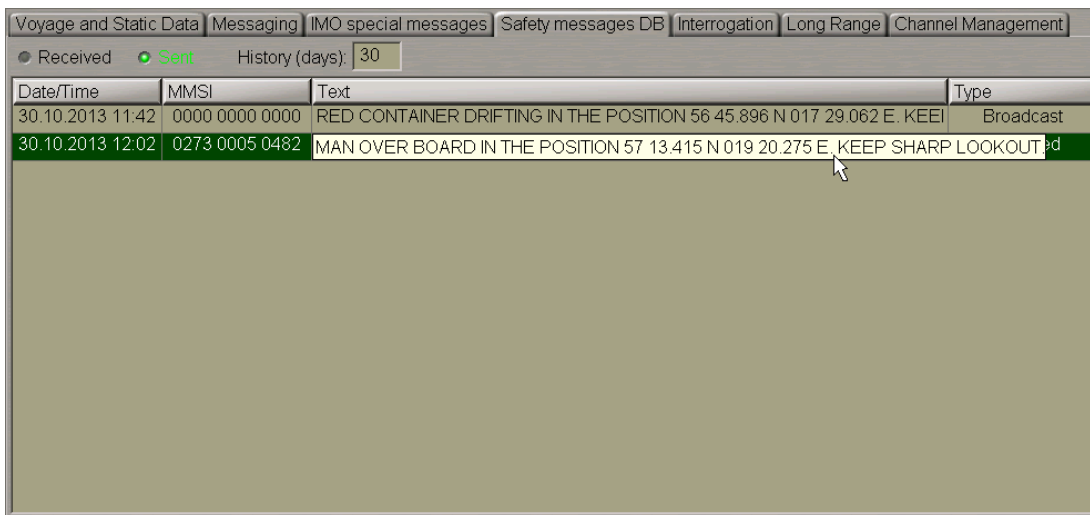

Date/Time	MMSI	Text	Type
30.10.2013 11:42	0000 0000 0000	RED CONTAINER DRIFTING IN THE POSITION 56 45.896 N 017 29.062 E. KEEI	Broadcast
30.10.2013 12:02	0273 0005 0482	MAN OVER BOARD IN THE POSITION 57 13.415 N 019 20.275 E. KEEP SHARP LOOKOUT	Alert

Safety AIS messages files are accessible with the use of the Data Tool utility, in the AIS safety messages group of AIS Data feature, and can be imported/exported from/to another PC.

The System Configuration utility features a capability to set the safety messages storage period up to 100 days (see document *Multi-Functional Display (v. 3.00.340). Installation Guide Part I, Chapter 2*, section *MFD Configuration*, paragraph *MFD Settings*, item 10).

Handling Targets

Setting of Safety Parameters in the Tracking of Targets

Open **Targets** panel by selecting the appropriate line of **Tasks List** menu in the tabs zone of the ECDIS task screen.

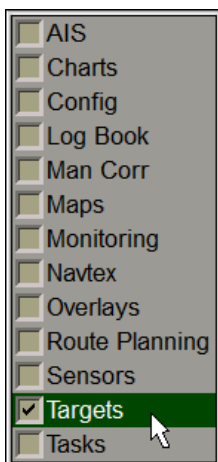

Use the tab in the top part of **Targets** panel, which will open up, to switch to **Target Table** page:

Name	40	41	42	43	44	37	47	48	49	50	51	52	53	54
Alias														
CPA (NM)	2.88	5.87	7.32	6.81	7.74	5.81	4.09	4.53	5.86	8.23	1.25	6.76	8.07	5.62
TCPA (min)	-9.7	-8.4	-6.9	-14.5	-9.3	-21.2	-21.2	-21.2	10.4	12.8	21.8	-16.4	-16.6	-19.2
SOG (kn)	45.3	43.5	29.4	26.8	33.1	11.3	15.0	13.1	22.4	12.3	16.8	19.5	15.8	12.8
COG (°)	145°	295.9°	65.7°	287.1°	281.1°	30.0°	5.9°	36.4°	84.2°	170.7°	81.6°	348.7°	358.2°	29.6°
Range (NM)	8.94	8.33	8.43	9.10	9.05	8.79	8.67	8.57	7.63	8.46	8.44	9.59	10.11	8.56
Bearing (°)	359.3°	350.7°	0.3°	351.7°	352.5°	352.7°	45.2°	5.8°	203.4°	236.6°	257.5°	317.5°	318.4°	352.4°
Bow X (NM)	7.7	-5.9	-20.9	-6.9	-8.1	55.4	-10.5	112.1	10.6	8.2	-2.6	11.1	16.8	49.3
TBow X (min)	-17.9	-9.0	25.4	-16.5	-13.8	-197.9	5.6	-346.8	-8.4	15.6	27.7	-37.6	-56.9	-164.8

In the top of **Targets** panel, which will open up, turn on the display of targets from the required sources by pressing the appropriate buttons: **ARPA A(B), Own** or **AIS**.

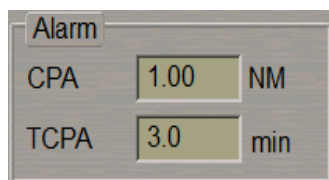

Alarm group contains windows for enter values of CPA/TCPA.

The CPA/TCPA **Tgt ID** alarm generation is turning on when both CPA and TCPA values of the target are smaller than the set values:

- CPA – to enter the minimum closest point of approach distance;
- TCPA – to enter the minimum time to the closest point of approach.

Handling Target Table

Open **Targets** panel by selecting the appropriate line of **Tasks List** menu in the tabs zone of the ECDIS task screen.

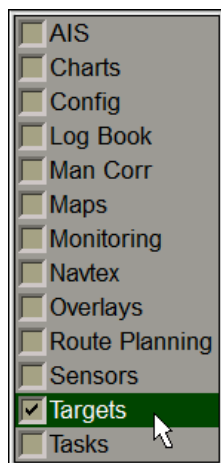

Use the tab in the top part of **Targets** panel, which will open up, to switch to **Target Table** page:

Name	71	74	75	77	78	79	80	91	92	93	95	100	138	182
Alias	Fellow													
CPA (nm)	3.08	2.39	2.01	1.04	0.74	0.07	1.94	3.29	3.70	3.67	1.49	1.33	3.45	0.64
TCPA (min)	-2.5	11.5	1.1	-3.1	-2.3	1.3	3.7	0.8	0.5	-0.3	-1.9	1.4	1.3	8.9
COG (°)	223.6°	335.2°	354.1°	202.5°	219.0°	340.8°	222.2°	268.9°	264.1°	244.8°	292.1°	23.1°	336.6°	336.7°
SOG (kn)	91.7	8.5	32.6	13.6	9.5	9.3	5.3	37.1	42.2	51.0	39.5	22.9	37.5	19.1
Range (nm)	5.18	3.82	2.11	1.46	1.00	0.34	2.12	3.35	3.72	3.68	2.16	1.41	3.57	3.75
Bearing (°)	264.4°	158.2°	85.4°	185.3°	197.6°	135.9°	140.1°	10.3°	2.0°	334.9°	331.3°	107.4°	68.9°	144.8°
Bow X (nm)	-4.6	-4.8	2.2	1.6	1.8	-0.1	7.0	-213.1	-44.4	-10.2	4.9	1.3	4.3	-0.9
TBow X (min)	-0.5	27.6	-0.3	-7.0	-7.7	1.7	-25.0	272.3	51.4	9.2	-7.7	1.2	-2.2	10.5

Target Table contains columns (ARPA and AIS targets) and rows with the targets information with availability of sorting by the relevant parameter:

- **Name** – target identifier;
- **Alias** – target identifier (up to 8 characters) assigned by the operator (the target is displayed on the Chart panel with this identifier regardless of settings in **AIS Target Identification** group);
- **CPA** – closest point of approach distance;
- **TCPA** – time to the closest point of approach;
- **COG** – target course over the ground;
- **SOG** – target speed over the ground;
- **Range** – distance to the target;
- **Bearing** – bearing to the target;
- **Bow X** – distance to the point where the target crosses the own ship course;
- **TBow X** – time to the point where the target crosses the own ship course.

Prompt Target Search

Open **Targets** panel by selecting the appropriate line of **Tasks List** menu in the tabs zone of the ECDIS task screen.

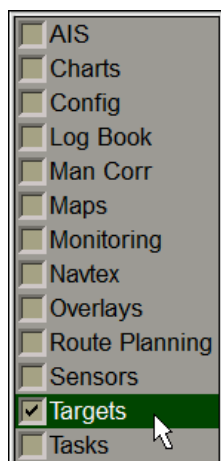

Use the tab in the top part of **Targets** panel, which will open up, to switch to **Target Table** page:

Name	40	41	42	43	44	37	47	48	49	50	51	52	53	54
Alias														
CPA (NM)	2.88	5.87	7.32	6.81	7.74	5.81	4.09	4.53	5.86	8.23	1.25	6.76	8.07	5.62
TCPA (min)	-9.7	-8.4	-6.9	-14.5	-9.3	-21.2	-21.2	-21.2	10.4	12.8	21.8	-16.4	-16.6	-19.2
COG (°)	14.5°	295.9°	65.7°	287.1°	281.1°	30.0°	5.9°	36.4°	84.2°	170.7°	81.6°	348.7°	358.2°	29.6°
SOG (kn)	45.3	43.5	29.4	26.8	33.1	11.3	15.0	13.1	22.4	12.3	16.8	19.5	15.8	12.8
Range (NM)	8.94	8.33	8.43	9.10	9.05	8.79	8.67	8.57	7.63	8.46	8.44	9.59	10.11	8.56
Bearing (°)	359.3°	350.7°	0.3°	351.7°	352.5°	352.7°	45.2°	5.8°	203.4°	236.6°	257.5°	317.5°	318.4°	352.4°
Bow X (NM)	7.7	-5.9	-20.9	-6.9	-8.1	55.4	-10.5	112.1	10.6	8.2	-2.6	11.1	16.8	49.3
TBow X (min)	-17.9	-9.0	25.4	-16.5	-13.8	-197.9	5.6	-346.8	-8.4	15.6	27.7	-37.6	-56.9	-164.8

Turn on the display of targets (see section *AIS*, paragraph *Handling AIS Targets* and section *ARPA*, paragraph *Target Display*).

Press the button with the target identifier in **Name** line of the Targets Table, e.g. "51".

The selected target will be displayed in the centre of the Chart panel highlighted with a flashing circle.

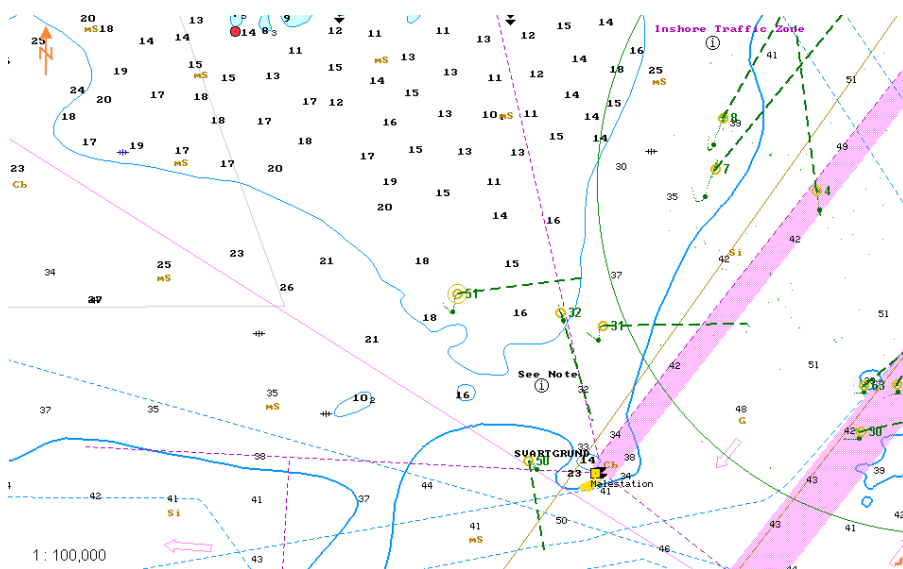

Turning On Mode of Associating AIS and ARPA Targets

Press the button with the name of the set display in the **Display Panel** window of the Control panel.

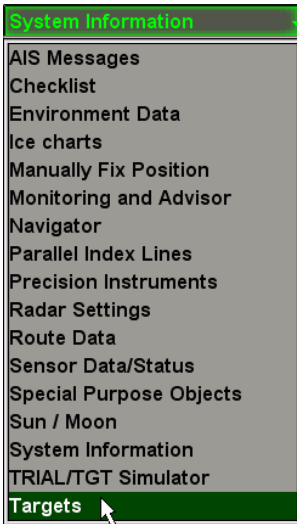

In the list, which will open up, select **Targets** line and press the left trackball button.

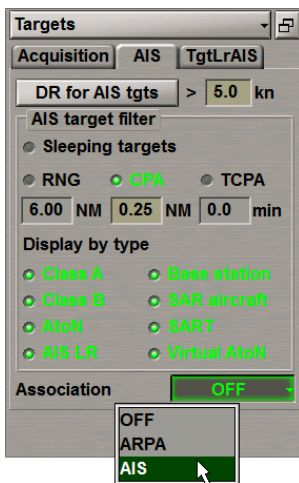

Select from the **Association** drop-down list the targets which will be displayed after the association on the ECDIS task screen (e.g. AIS).

If association conditions are fulfilled, the ARPA target continues to be tracked but is not displayed on the ECDIS task screen any more.



The data card of such AIS target displays bearing and distance to its associated ARPA target in the bottom line.

If association conditions exceeds the set limits, the ARPA target is automatically displayed on the screen.



Turning On DR Mode for AIS Targets

Press the button with the name of the set display in the **Display Panel** window of the Control panel.

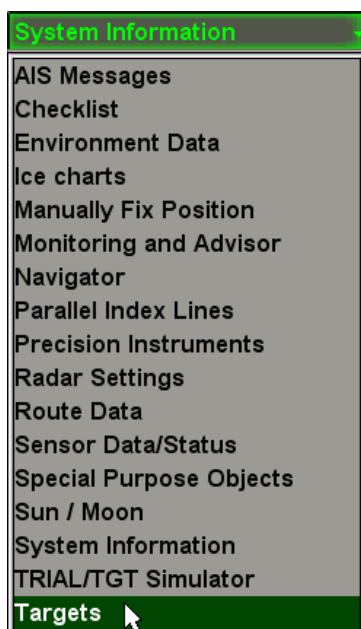

In the list, which will open up, select **Targets** line and press the left trackball button. Open **AIS** page.

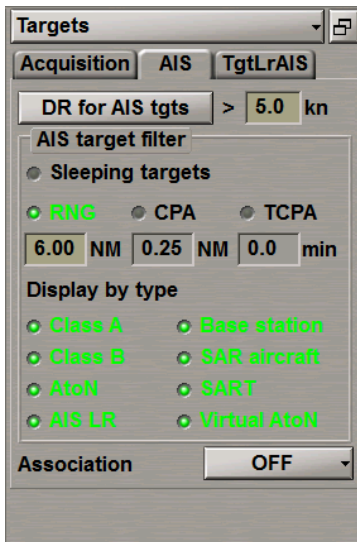

In the input line to the right of the **DR for AIS tgts** button, set the minimum speed of AIS targets for the DR mode.

To turn on the DR mode for AIS targets whose speed is equal to and higher than the set value, press the **DR for AIS tgts** button.

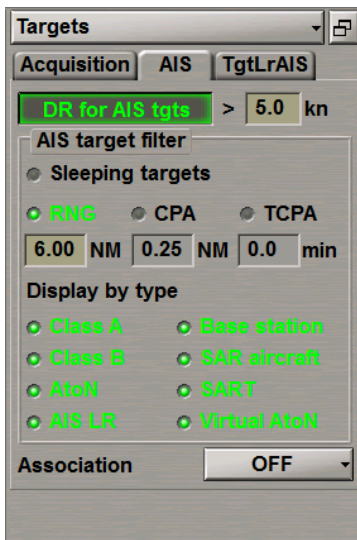

Filtering Lost Targets

Press the button with the name of the set display in the **Display Panel** window of the Control panel.

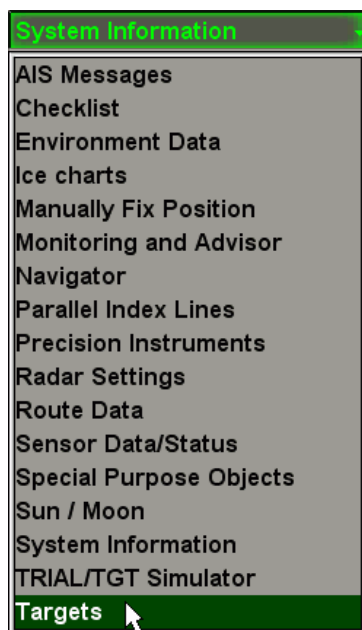

In the list, which will open up, select **Targets** line and press the left trackball button.

Open **Acquisition** page. Check the **Enable "Lost tgt" warning** checkbox.

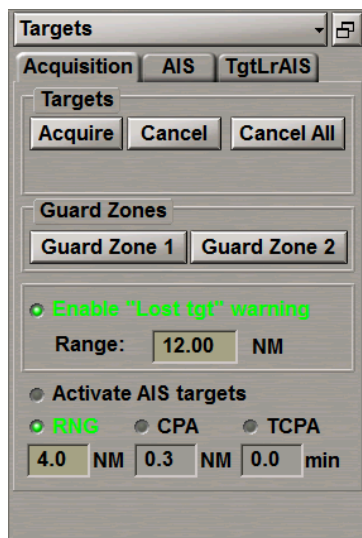

Use the **Range** input box to set the distance within which the **Lost Tgt** warning will be generated when the ARPA or AIS loses a target. Beyond the set distance the lost targets are not at all displayed on the ECDIS task screen any more without warning.

Filtering AIS Targets

Press the button with the name of the set display in the **Display Panel** window of the Control panel.

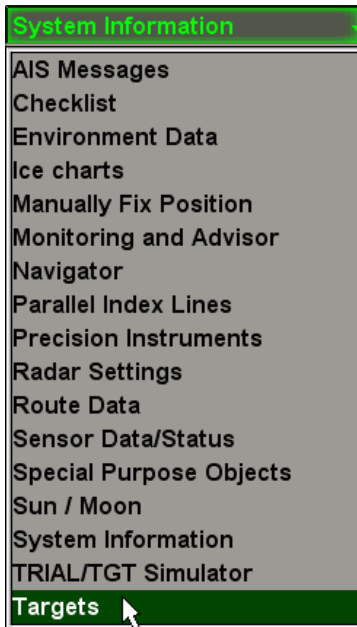

In the list, which will open up, select **Targets** line and press the left trackball button.

Open the AIS page.

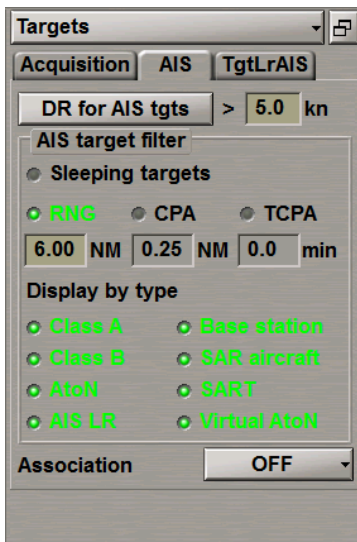

Check the **Sleeping targets** checkbox to turn on filtering of sleeping AIS targets by one of the following criteria:

- Check the **RNG** checkbox and enter the necessary range in the input window to set the distance beyond which the sleeping AIS targets will not be displayed;
- Check the **CPA** checkbox and enter the necessary CPA for sleeping AIS targets. No sleeping AIS targets whose CPA is larger than the set value will be displayed;
- Check the **TCPA** checkbox and enter the necessary TCPA for sleeping AIS targets. No sleeping AIS targets whose TCPA is larger than the set value will be displayed.

By default, the display of all the AIS target types is enabled:

- Class A;
- Class B;
- AtoN;
- AIS LR;
- Base station;
- SAR aircraft;
- SART;
- Virtual AtoN.

Uncheck as required the relevant checkboxes to turn off the display of certain types of AIS targets on the ECDIS task screen.

Note: If the sleeping AIS targets filtering is enabled, or the display of some AIS targets type is turned off, the **AIS filter** important indication is displayed in the **Vectors** window of the Control Panel (see also document *Multi-Functional Display (v. 3.00.340). Functional Description, Chapter 4, section Indications, paragraph Display of Important Indications*).

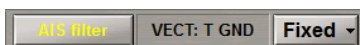

Open the **Acquisition** page.

By default, the **Activate AIS targets** filter is turned off.

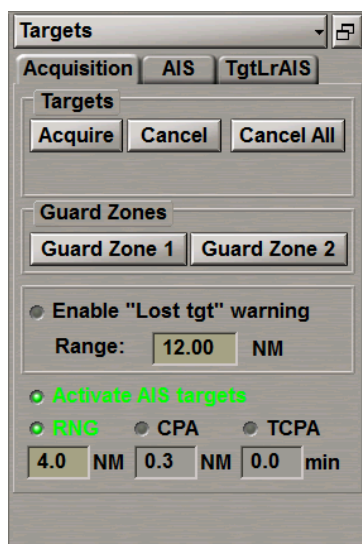

Check the **Activate AIS targets** checkbox for the automatic activation of sleeping AIS targets by one of the following criteria:

- Check the **RNG** checkbox and enter the necessary range in the input window to set the distance. All the AIS targets closer than the set range will be activated automatically;
- Check the **CPA** checkbox and enter the necessary CPA for the sleeping AIS targets. All the sleeping AIS targets whose CPA is smaller than the set value will be activated automatically;
- Check the **TCPA** checkbox and enter the necessary TCPA for the sleeping AIS targets. All the sleeping AIS targets whose TCPA is smaller than the set value will be activated automatically.

Obtaining Information on Target

Turn on the display of targets (see section *AIS*, paragraph *Handling AIS Targets* and section *ARPA*, paragraph *Target Display*).

Position free View cursor on the necessary target; the cursor will change its form. Press the left trackball button: the target data card with its parameters will be displayed next to the target:

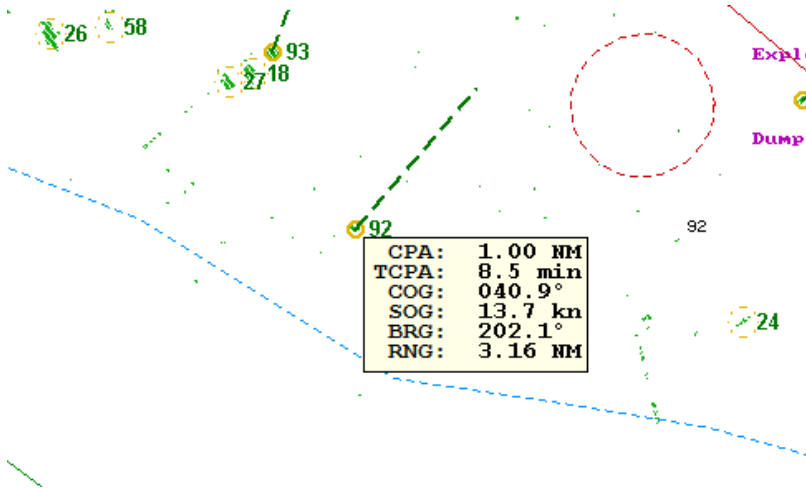

Chapter 11.

Obtaining of Information in the ECDIS Task

This chapter describes the procedure used in the reception of all kinds of information in the ECDIS task.

<u>Obtaining Information on Vector Chart Objects</u>	369
Obtaining Information on Point Type Objects	369
Obtaining Information on Line and Area Type Objects	370
<u>Obtaining Information on Vector Charts</u>	371
<u>Obtaining Information on Updating Objects</u>	372
<u>Obtaining Information on Map Objects</u>	373
<u>Obtaining Information on Tides and Currents</u>	374
Obtaining Information on the Change of Tidal Heights	374
Display of Tidal Heights on the Chart Panel	379
Obtaining Information on Tidal Currents	380
Obtaining Information on Surface Currents	381
Use of Animation	382
<u>Obtaining Information on Sun/Moon</u>	384
<u>Obtaining Current System Information</u>	387
<u>Obtaining Information on Ports</u>	389
Obtaining Information by Port Name	389
Obtaining Information by the Region Name	390
Obtaining Information by the Country Name	391
Obtaining Information by the Cursor Position on the Chart Panel	392
Quick Search for Selected Port	393
<u>Obtaining NAVTEX Information</u>	394
Work with NAVTEX Message Database	394
Work with Messages	398
<u>Obtaining Information on Own Ship AIS Data</u>	401
<u>Obtaining Information on Currently License</u>	402

<u>Obtaining Information on Input/Output Messages</u>	403
Display of Data Flow Between the MFD and Different External Devices	404
COM Trace Record	405

Obtaining Information on Vector Chart Objects

Obtaining Information on Point Type Objects

Set the display of the required area by using Scaling and Review functions.

Press **i** button on the Control panel: **Info** panel will open up in the bottom part of the screen.

Position the acquisition cursor, which will appear, on the object which information is required to be obtained on.

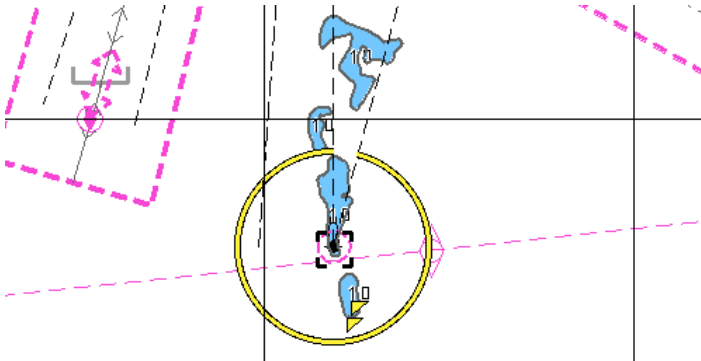

Press the left trackball button. **Info** panel will display (under the chart name) the list of pages with available information on the objects, which fall within the acquisition cursor outline.

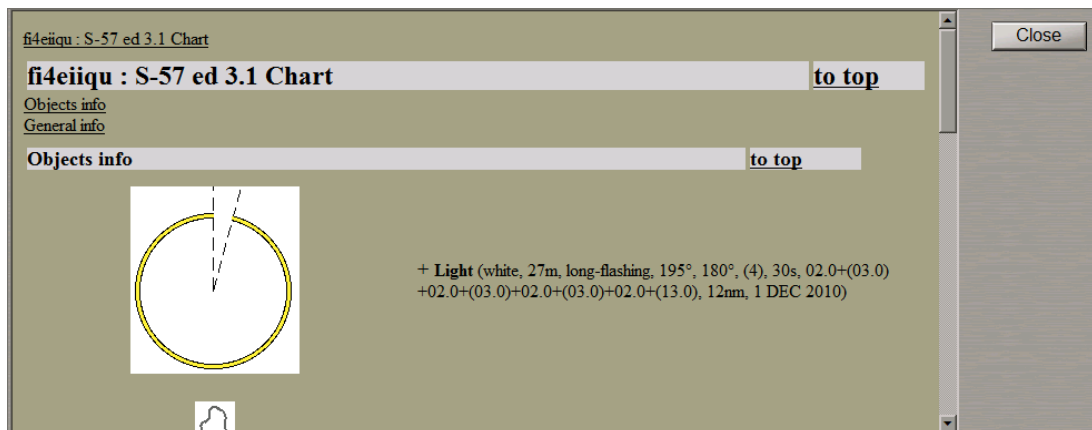

Select the necessary notation by positioning the cursor on the name and press the left trackball button: **Info** panel will open a page with information on the selected objects:

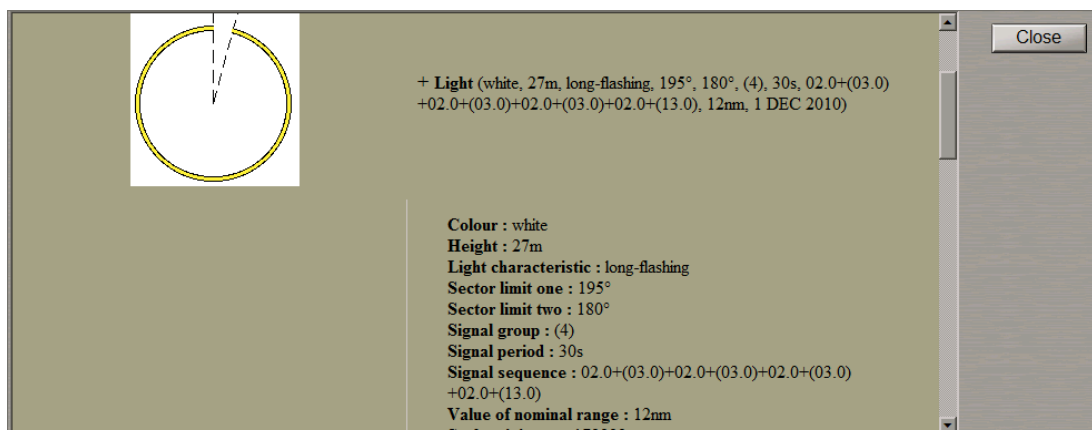

Obtaining Information on Line and Area Type Objects

Set the display of the required area by using Scaling and Review functions. Press **i** button on the Control panel. **Info** panel will open up in the bottom part of the screen.

Position the acquisition cursor, which will appear, on the boundary of an area type object or any part of a line type object which information is required to be obtained on.

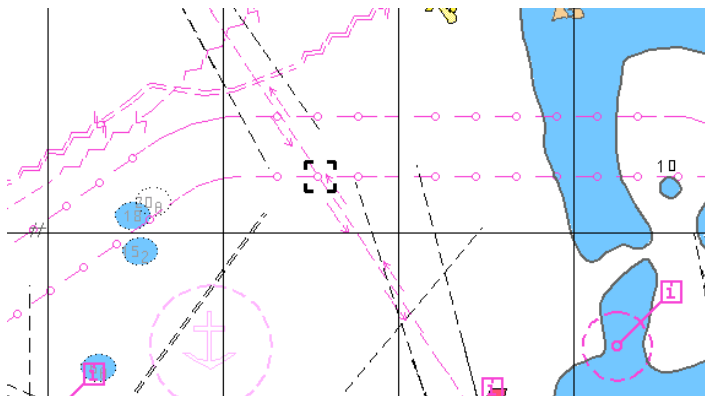

Press the left trackball button. **Info** panel will display (under the chart name) the list of pages with available information on the objects, which fall within the acquisition cursor outline.

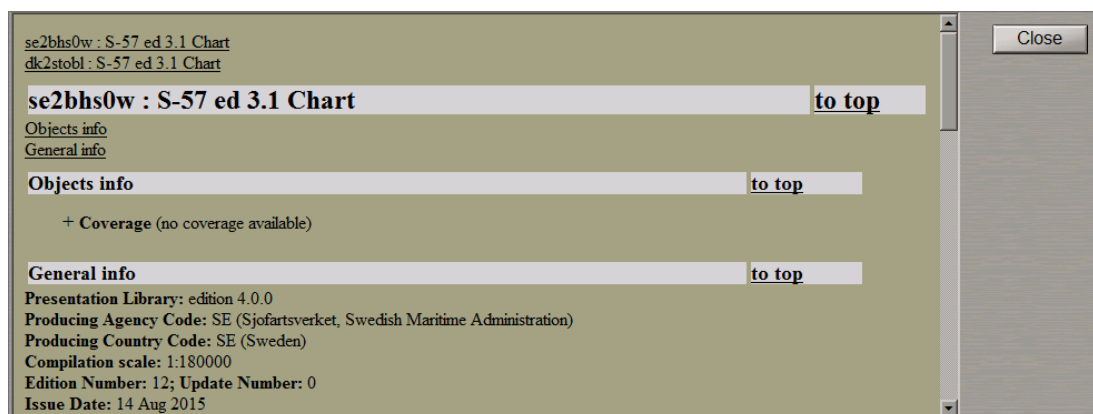

Select the necessary notation by positioning the cursor on the name and press the left trackball button: **Info** panel will open a page with information on the selected objects.

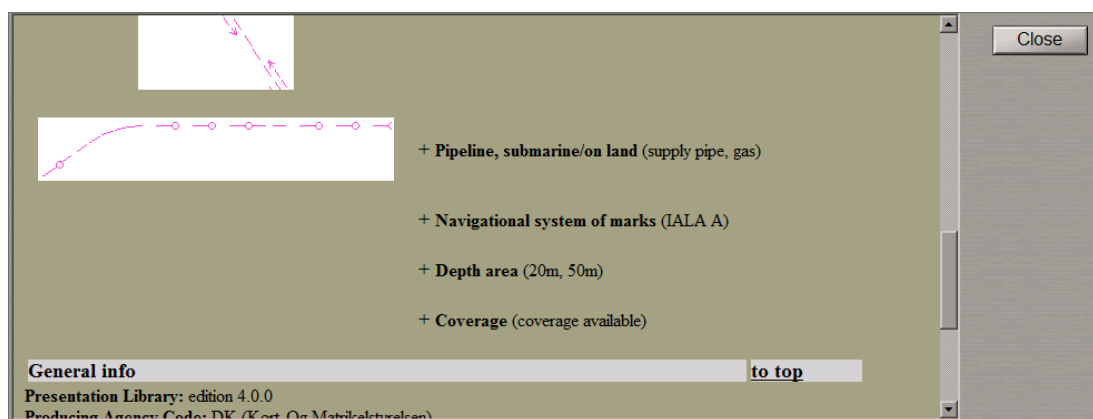

Obtaining Information on Vector Charts

Set the display of the required area by using Scaling and Review functions.

Press **i** button on the Control panel. **Info** panel will open up in the bottom part of the screen.

Position the acquisition cursor, which will appear, on point of the chart which information is required to be obtained on.

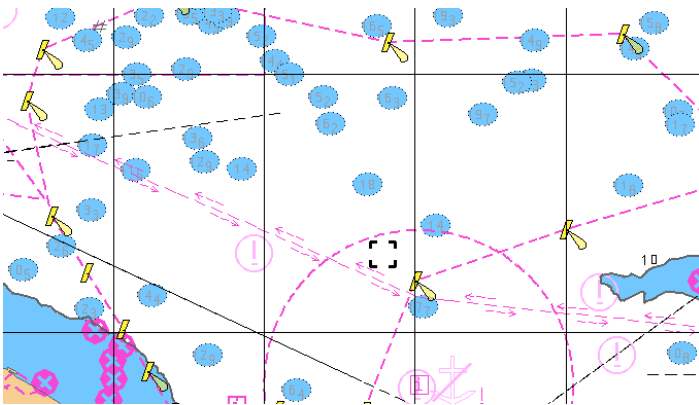

Press the left trackball button. **Info** panel will display (under the chart name) the list of pages with available information on the objects which fall within the acquisition cursor outline.

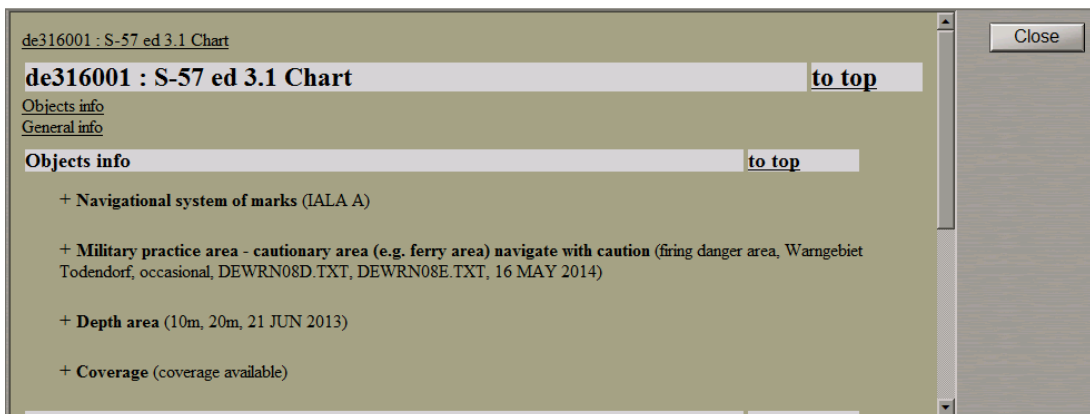

Select **General Chart Information** notation by positioning the cursor on it, and press the left trackball button. The page with information on the vector chart will open up.

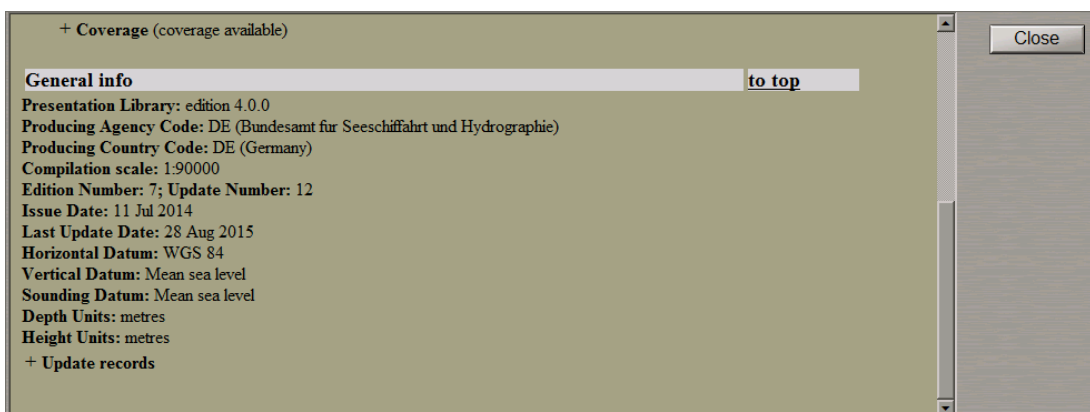

Obtaining Information on Updating Objects

Set the display of the required area by using Scaling and Review functions.

Press **i** button on the Control panel. **Info** panel will open up in the bottom part of the screen.

Attention! Point type objects cannot be displayed on scales smaller than 1:600,000.

Position the acquisition cursor, which will appear, on the updating object which information is required to be obtained on.

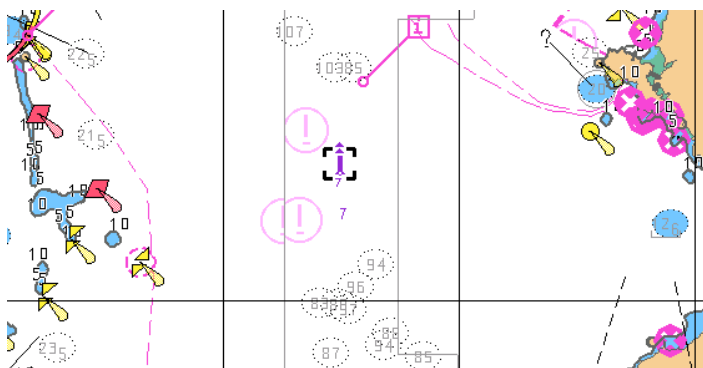

Press the left trackball button. **Info** panel will display (above the chart name) the list of pages with available information on the updating objects and navigation chart which fall within the acquisition cursor outline.



Select **Manual correction** by positioning the cursor on this notation and press the left trackball button. **Info** panel will display the page with information on the categories of updating objects, which fall within the acquisition marker outline.

Select the required object category by positioning the cursor on it and press the left trackball button. The window will display the page with information on the objects of this category.



Obtaining Information on Map Objects

Set the display of the required area by using Scaling and Review functions. Press  button on the Control panel. **Info** panel will open up in the bottom part of the screen.



Attention! Point type objects cannot be displayed on scales smaller than 1:600,000.

Position the acquisition cursor, which will appear, on the map object which information is required to be obtained on.

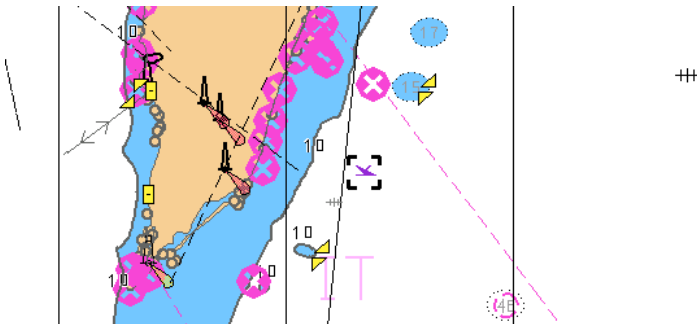

Press the left trackball button. **Info** panel will display (above the chart name) the list of pages with available information on the map objects and navigation chart, which fall within the acquisition cursor outline.



Select **User charts layer A (B)** by positioning the cursor on this notation and press the left trackball button. **Info** panel will display the page with information on the categories of map objects which fall within the acquisition marker outline.

Select the required object category by positioning the cursor on it and press the left trackball button. The window will display the page with information on the objects of this category.

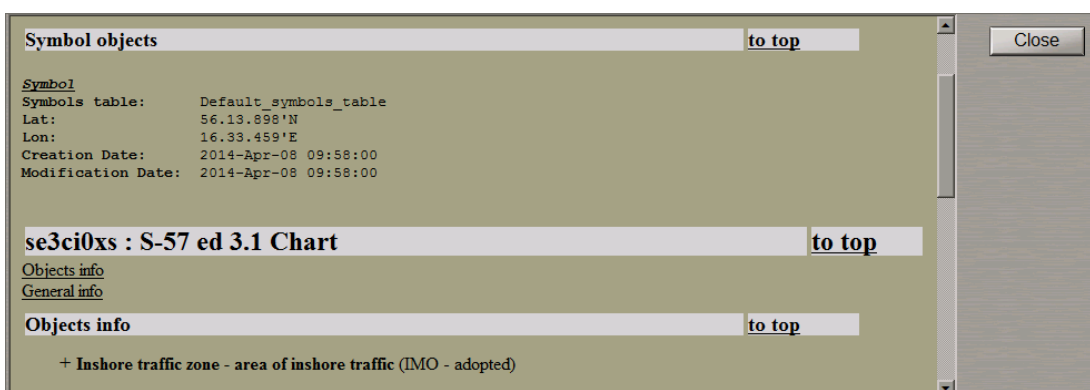

Obtaining Information on Tides and Currents

Obtaining Information on the Change of Tidal Heights

Open **Tasks** panel by selecting the appropriate line of **Tasks List** menu in the tabs zone of the ECDIS task screen.

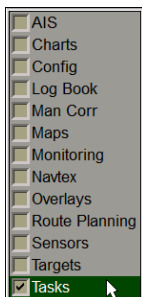

Use the tab in the top part of **Tasks** panel to switch to **Tides** page.

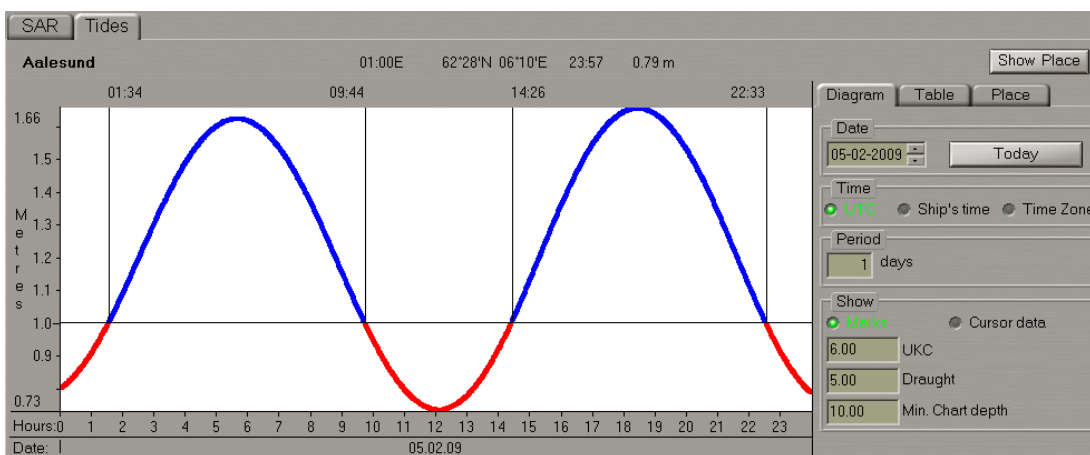

Use the tab in the top right part of **Tides** page, which will open up, to switch to **Place** tab.

Place	Coordinates	Time Zone
Aalesund	62°28'N 06°10'E	01:00E
Abaiang Atoll	01°49'N 173°02'E	12:00E
Abashiri Ko	44°01'N 144°17'E	09:00E
Abbot Point	19°53'S 148°05'E	10:00E
Abemama	00°29'N 173°52'E	12:00E
Aber Benoit	48°35'N 04°37'W	01:00E
Aberdaron	52°48'N 04°43'W	00:00
Aberdeen	46°58'N 123°51'W	08:00W
ABERDEEN	57°09'N 02°05'W	00:00
Aberdovey	52°32'N 04°03'W	00:00
Aberporth	52°08'N 04°33'W	00:00
Aberystwyth	52°24'N 04°05'W	00:00
Abidjan Entrance	05°15'N 03°50'W	00:00
Ahlaton Lake	70°50'S 68°25'W	03:00W

In the right-hand part of **Place** tab, which will open up, select the reference point by using one of the following procedures:

- Enter the reference point name in **By name** input line and press <Enter> key;
- Check **All Places** checkbox.

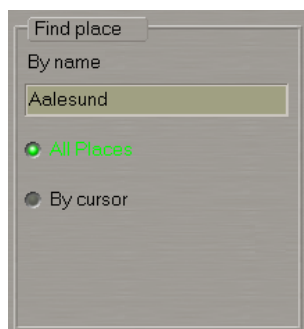

In the list in the left-hand part of the page, which will open up, select the reference point and double click the left trackball button.

- Check **By cursor** checkbox; enter the radius of the area coverage circle in **Distance** input line, which will open up.

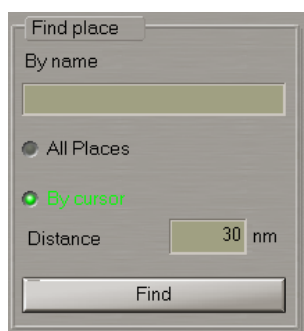

Press **Find** button. Position the graphic cursor, which will appear, on the point within the Chart panel which will be the centre of the area coverage circle.

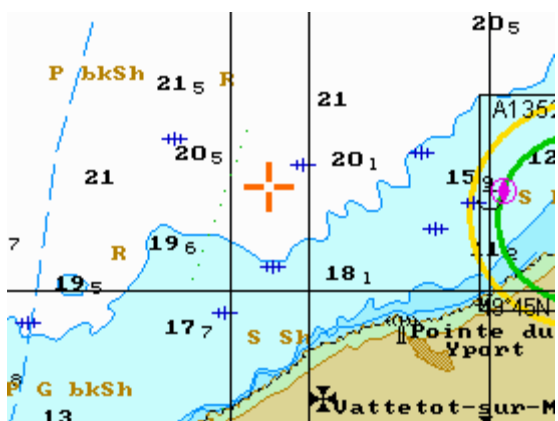

Press the left trackball button. In the list of reference points, which fall within the coverage area in the left-hand part of the page, select the reference point and double click the left trackball button.

Information Displayed Graphically

After the selection of the reference point, **Diagram** tab will open up, displaying the tidal curve for the selected reference point.

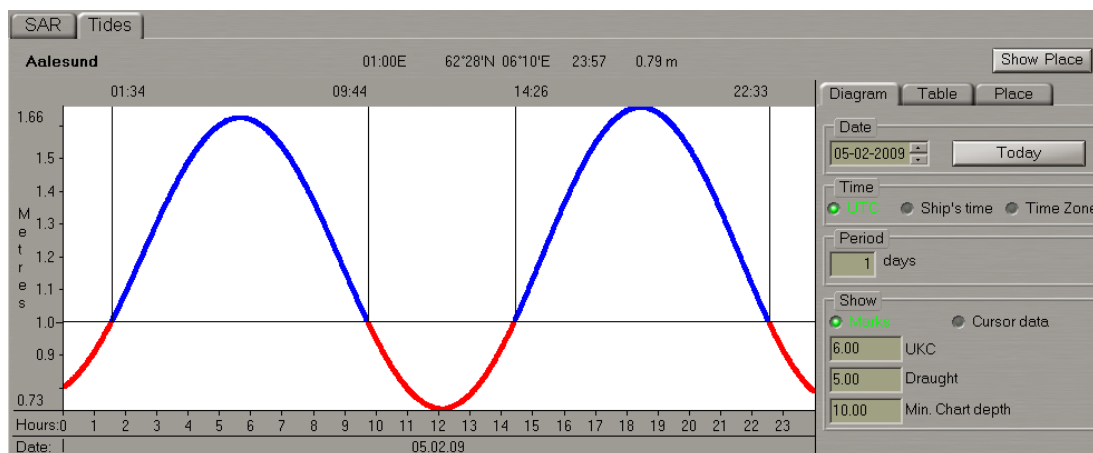

In **Date** line of **Diagram** tab, select the date starting from which the tidal heights will be calculated. Use **Period** input line to enter the period which tidal heights are required to be calculated for.

The following parameters can be set:

- **UKC** – under keel clearance;
- **Draught** – ship's draught;
- **Min. Chart depth** – the minimum depth on the chart.

Check **Marks** checkbox to show the time marks on the diagram.

On the graph, blue is used for showing the time periods when the actual depth is safe, and red for showing the time intervals with dangerous depths.

Check **Cursor Data** checkbox. Position the cursor on the tidal curve and by moving the cursor with the trackball, set the necessary time value in the cursor information window.

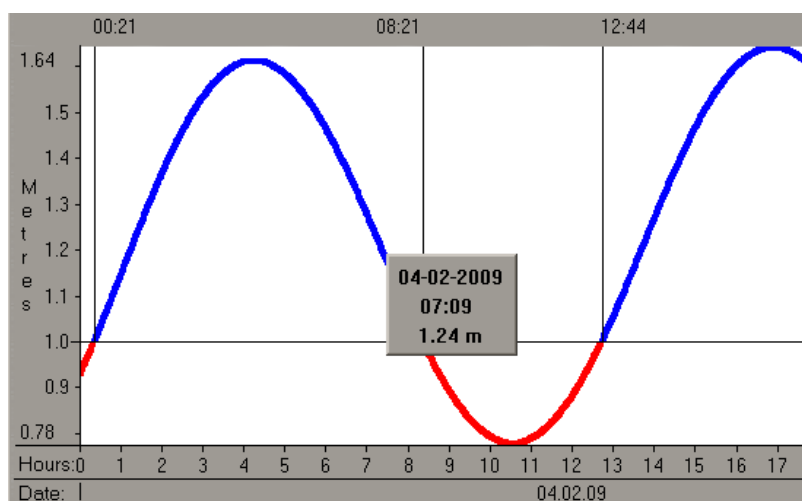

Read the tidal height value in the cursor information window.

Information Displayed in a Tabular Form

After the selection of the reference point, **Diagram** tab will open up displaying the tidal curve for the selected reference point.

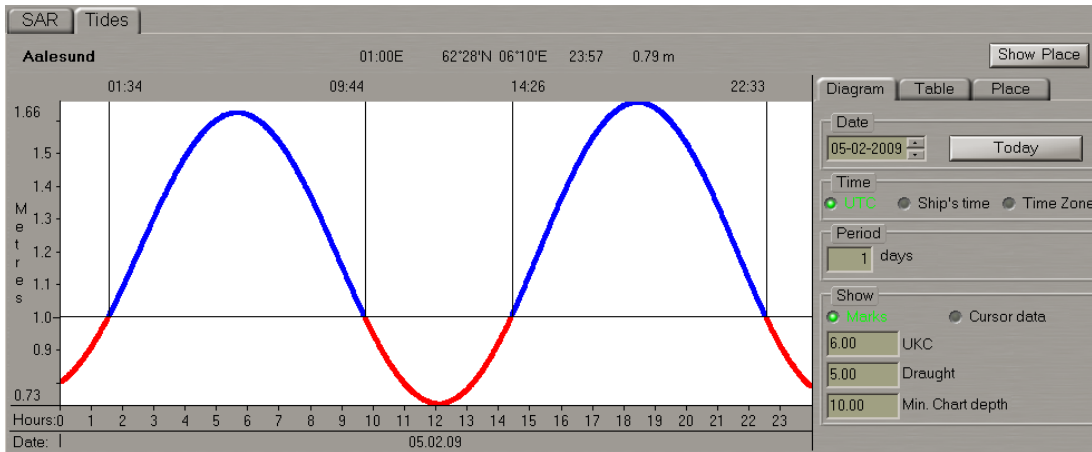

Use the tab in the top right part of the page to switch to **Table** tab.

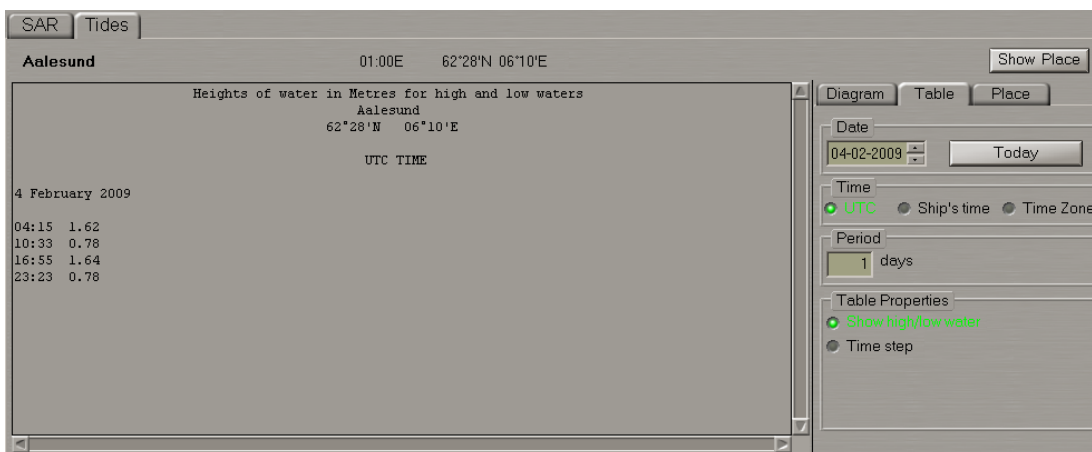

In **Date** line of **Table** tab, select the date starting from which the tidal heights will be calculated. Use **Period** input line to enter the period which tidal heights are required to be calculated for.

To calculate tidal tables, use one of the following procedures:

- In **Table Properties** group, check **Show high/low water** checkbox.

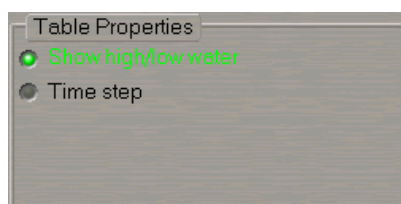

The left-hand part of the page will display a table of high and low water.

Heights of water in Metres for high and low waters	
Aalesund	
62°28'N 06°10'E	
UTC TIME	
4 February 2009	
04:15	1.62
10:33	0.78
16:55	1.64
23:23	0.78

- In **Table Properties** group, check **Time step** checkbox; press  button in the activated line for the input of the tidal height calculations discretion.

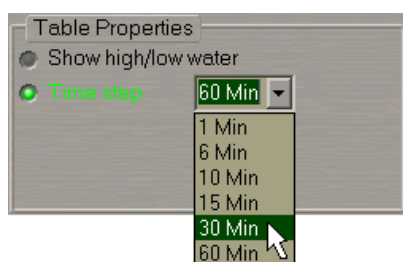

In the list, which will open up, select the necessary tidal height calculation discretion and press the left trackball button. The left-hand part of the page will display the tidal height table calculated with the set discretion.

Heights of water in Metres for regular intervals											
Aalesund											
62°28'N 06°10'E											
UTC TIME											
4 February 2009											
00:00	0.93	04:00	1.61	08:00	1.07	12:00	0.88	16:00	1.60	20:00	1.24
00:30	1.03	04:30	1.61	08:30	0.97	12:30	0.96	16:30	1.64	20:30	1.13
01:00	1.15	05:00	1.59	09:00	0.89	13:00	1.05	17:00	1.64	21:00	1.03
01:30	1.26	05:30	1.54	09:30	0.83	13:30	1.16	17:30	1.63	21:30	0.94
02:00	1.37	06:00	1.46	10:00	0.79	14:00	1.27	18:00	1.59	22:00	0.87
02:30	1.46	06:30	1.38	10:30	0.78	14:30	1.37	18:30	1.52	22:30	0.81
03:00	1.54	07:00	1.28	11:00	0.79	15:00	1.47	19:00	1.44	23:00	0.78
03:30	1.59	07:30	1.17	11:30	0.82	15:30	1.55	19:30	1.34	23:30	0.78

Take the necessary readings in the calculated tables.

Display of Tidal Heights on the Chart Panel

Press the button with the name of the set display in the **Display Panel** window of the Control panel.

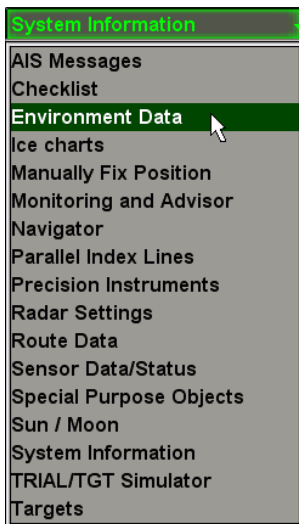

In the list, which will open up, select **Environment Data** line and press the left trackball button.

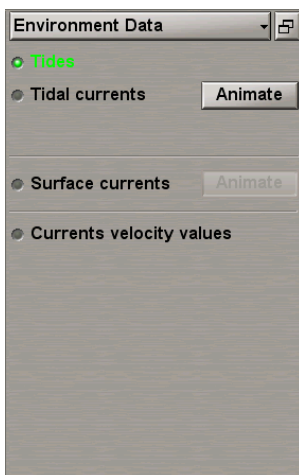

In **Environment Data** display, which will open up, check **Tides** checkbox. The Chart panel displays tidal heights in the reference points as of the current time.

Press **Show place** button in the top right part of **Tides** page on **Tasks** panel. The selected reference point is displayed in the centre of the Chart panel.

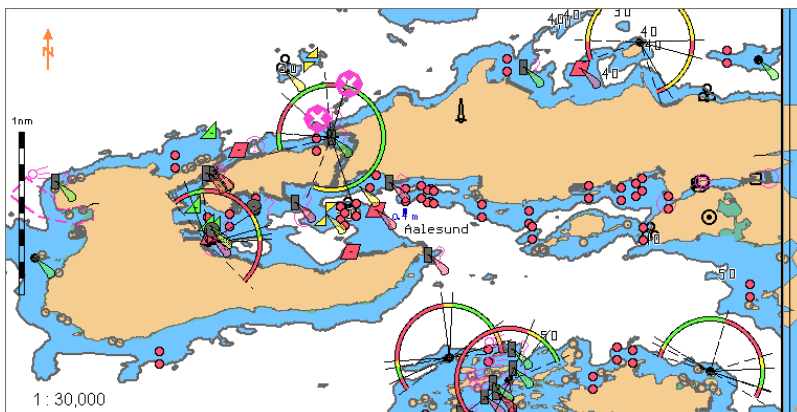

Obtaining Information on Tidal Currents

Set the display of the area within the chart screen boundary by using Scaling and Review functions. Press the button with the name of the set display in the **Display Panel** window of the Control panel.

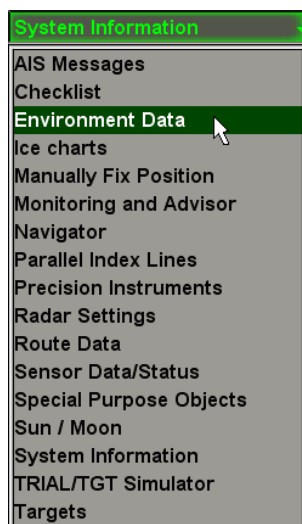

In the list, which will open up, select **Environment Data** line and press the left trackball button.

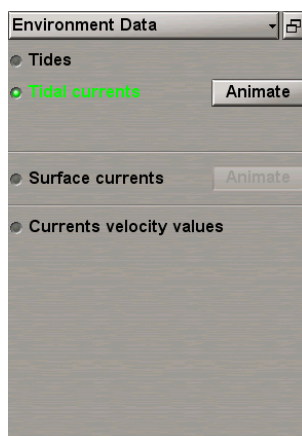

In **Environment Data** display, which will open up, check **Tidal currents** checkbox. The Chart panel displays tidal current vectors as of the current time.

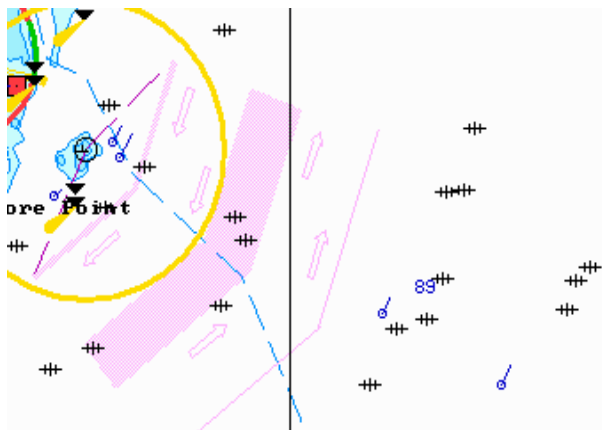

Check **Currents velocity values** checkbox. The Chart panel will display digitally the values of tidal current speed.

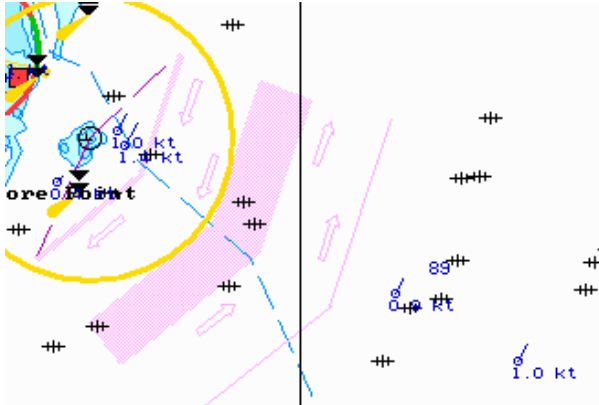

Obtaining Information on Surface Currents

Press the button with the name of the set display in the **Display Panel** window of the Control panel.

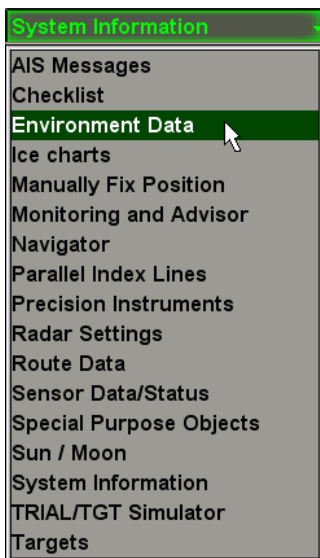

In the list, which will open up, select **Environment Data** line and press the left trackball button.

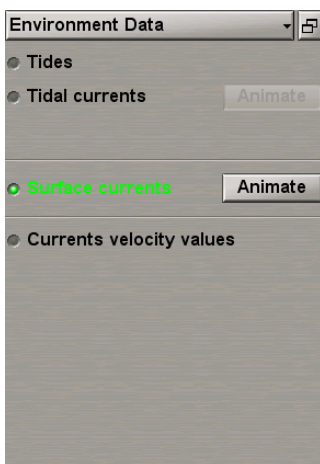

In **Environment Data** display, which will open up, check **Surface currents** checkbox.

The Chart panel displays surface currents vectors as of the current time.

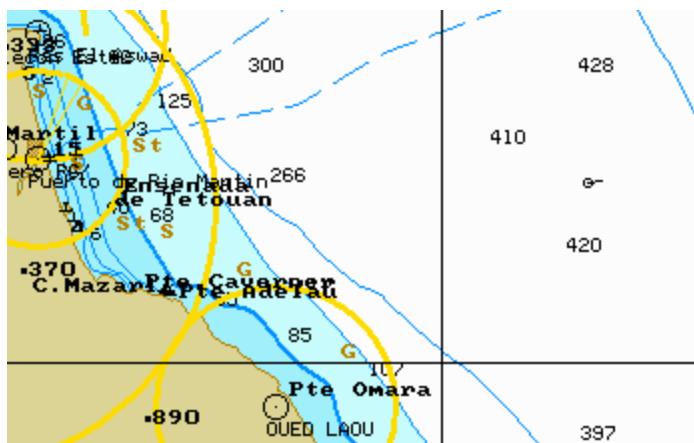

Check Currents velocity values checkbox. The Chart panel will display digitally the values of surface current speed.

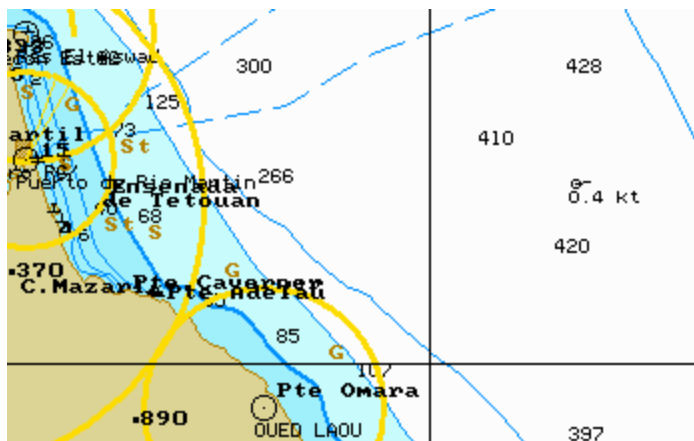

Use of Animation

Set the display of the area within the chart screen boundaries by using Scaling and Review functions. Press the button with the name of the set display in the **Display Panel** window of the Control panel.

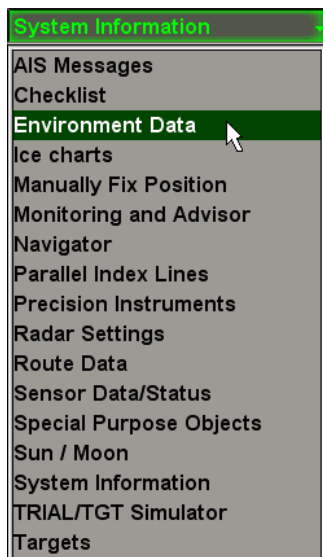

In the list, which will open up, select **Environment Data** line and press the left trackball button.

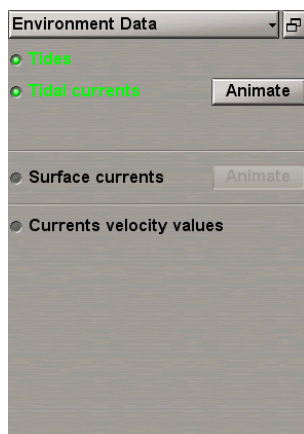

In **Environment Data** display, check the checkboxes of the parameters whose value change dynamics is required to be viewed. Press the activated **Animate** button to the right of the names of parameters.

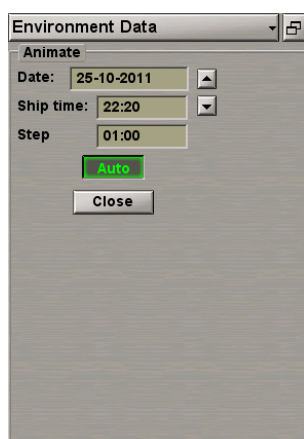

In **Date** and **Ship time** input lines of **Animate** group, which will open up, enter the required viewing start date and time.

Use **Step** input line to enter the discretion of the parameter value change.

View the changes in the parameter values by using   buttons.

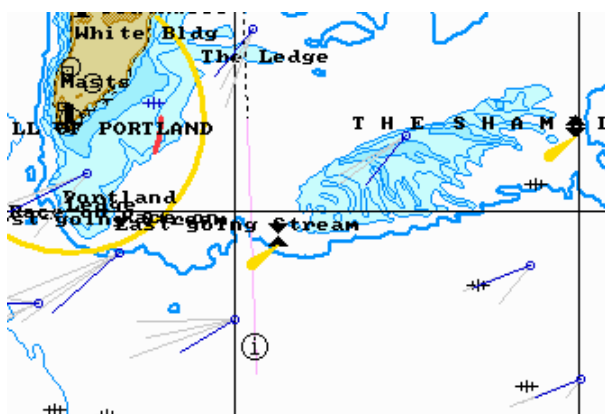

On the Chart panel, the selected parameters will change with the set discretion.

For the automatic change of parameters with the set discretion, press **Auto** button.

Obtaining Information on Sun/Moon

Press the button with the name of the set display in the **Display Panel** window of the Control panel.

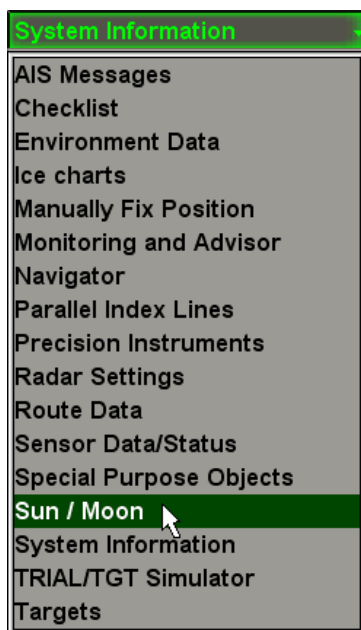

In the list, which will open up, select **Sun/Moon** line and press the left trackball button.



The **Sun/Moon** display is intended for calculating and displaying data on sunrise/sunset and moonrise/moonset in any set point for a certain date.

In the Date input box enter the date by rolling the trackball, or enter it from the keyboard.

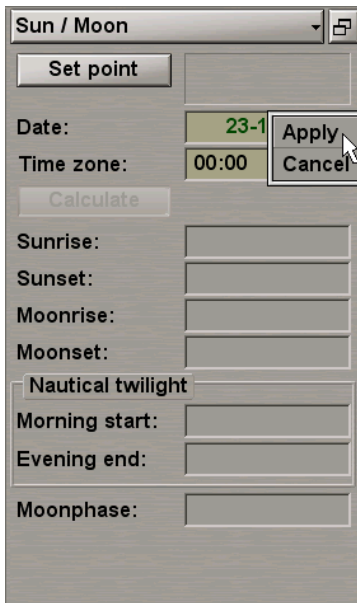

The screenshot shows a dialog box titled "Sun / Moon". At the top left is a dropdown menu with "Sun / Moon" and a right arrow icon. Below it is a "Set point" button. The "Date:" field contains "23-1" and the "Time zone:" field contains "00:00". To the right of these fields are "Apply" and "Cancel" buttons. Below these is a "Calculate" button. The dialog also contains several empty input fields for "Sunrise:", "Sunset:", "Moonrise:", "Moonset:", "Morning start:", "Evening end:", and "Moonphase:". A "Nautical twilight" checkbox is also present.

Press the right trackball button and select **Apply**.

In the Time zone input box enter the time zone by rolling the trackball, or enter it from the keyboard.

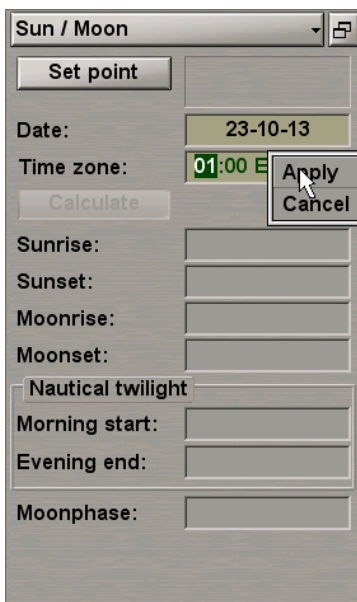

The screenshot shows the same "Sun / Moon" dialog box. The "Date:" field now contains "23-10-13" and the "Time zone:" field contains "01:00 E". The "Apply" button is highlighted with a mouse cursor.

Press the right trackball button and select **Apply**.

Press **Set point** button.

Position the graphic cursor which will appear in the required point on the Chart panel.

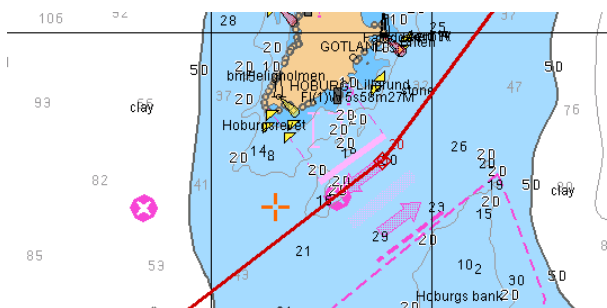

The graphic cursor coordinates are displayed in the **Set point** information window in the bottom part of the Control panel.

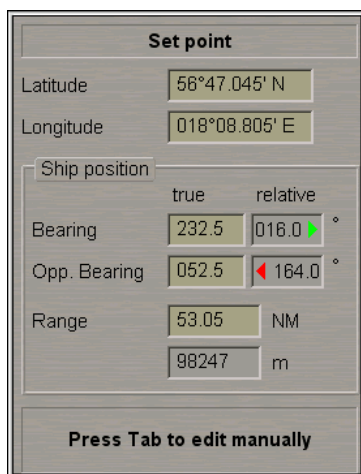

Press the activated **Calculate** button.

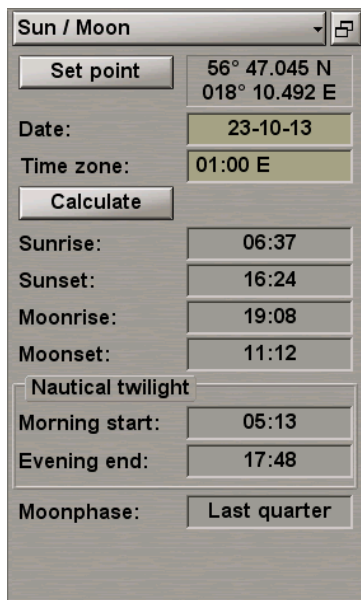

The **Sun/Moon** display will show the following data:

- Sunrise – sunrise time;
- Sunset – sunset time;
- Moonrise – moonrise time;
- Moonset – moonset time;
- Nautical twilight – nautical twilight time:
 - Morning start - morning twilight start;
 - Evening end - evening twilight end;
- Moonphase – moon phase.

Obtaining Current System Information

Press the button with the name of the set display in the **Display Panel** window of the Control panel.

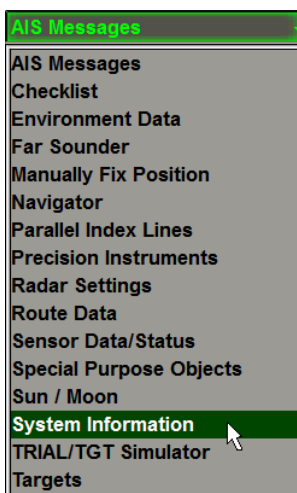

In the list, which will open up, select **System Information** line and press the left trackball button.

System Information	
Drift	135.0° - 0.0 kn
Current	354.0° - 0.0 kn
SF CNT	50 m
True wind	119.9° - 10.0 m/s
Rel. wind	075.7°(P) - 9.5 m/s
Water t°	18.0 °C
Depth	28.0 m
ECHOSOUNDER 1	
Tide height	
5.1 m	Sandettie Bank

System Information display is intended for presenting the following data:

- **Drift** – drift direction and speed;
- **Current** – summary value of the surface and tidal currents calculated for the current time at the current ship position;
- **SF CNT** – current safety contour value determined by the ECDIS task;
- **True wind** – true wind direction and speed (from the wind sensor data);
- **Rel. wind** – relative wind direction and speed (from the wind sensor data);
- **Water t°** – water temperature value from the temperature sensor data;
- **Depth** – value of water depth under the keel (from the sounder data);
- **Tide height** – expected tidal height value calculated for the current time at the reference point closest to the ship position, and the name of this reference point.

To select the true wind vector display mode on the ECDIS task screen, open the **Monitoring** panel by selecting the appropriate item of the **Tasks List** menu in the tabs zone of the ECDIS task screen.

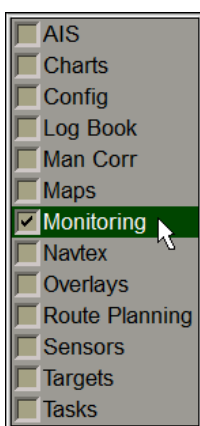

Use the tab in the top part of **Monitoring** panel, which will open up, to switch to the **Route Monitoring** page.

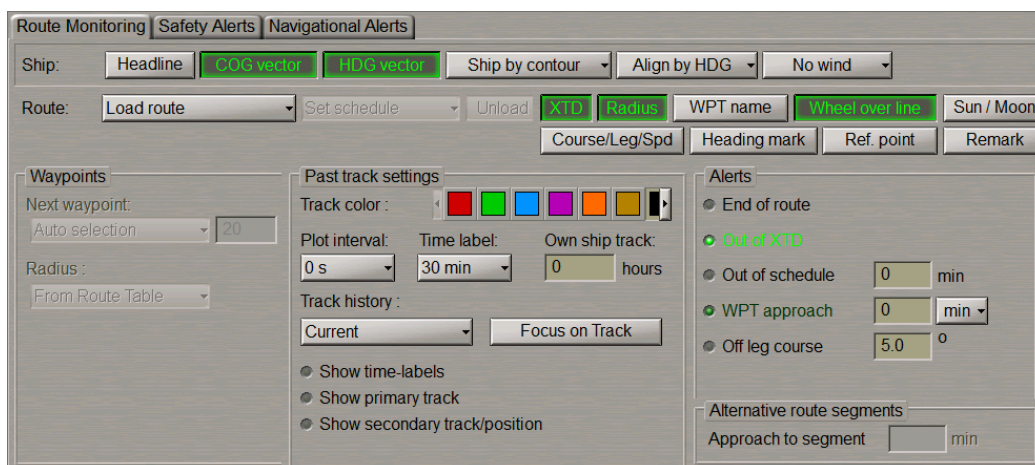

Press the **Wind vector** button:



Select the necessary display mode (see document *Multi-Functional Display (v. 3.00.340) .Functional Description, Chapter 2, section Other Sensors, paragraph Wind Interface*).

Obtaining Information on Ports

Open **Tasks** panel by selecting the appropriate line of **Tasks List** menu in the tabs zone of the ECDIS task screen.

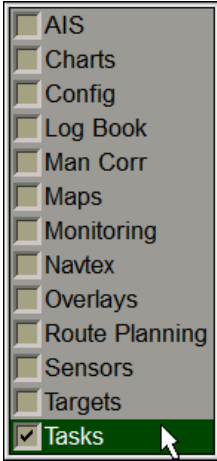

Use the tab in the top part of **Tasks** panel to switch to **Ports** page:

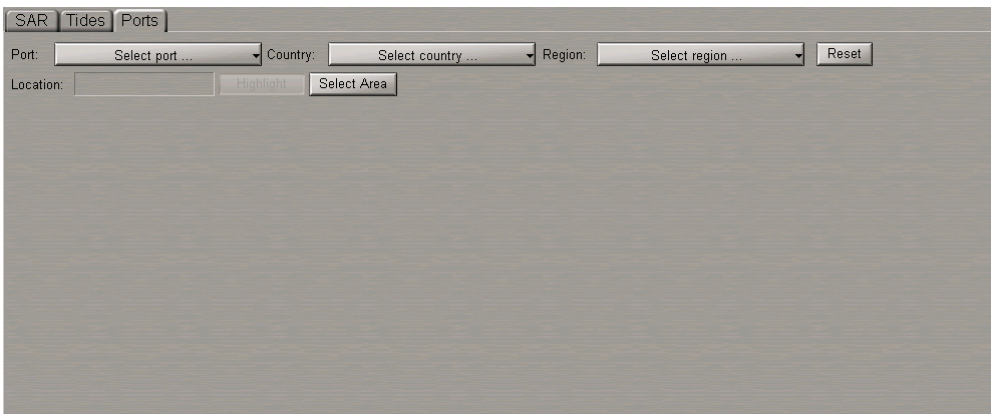

To obtain information on the required port, use the following procedure.

Obtaining Information by Port Name

Press **Port** button. Type the first letters of port name or select the port from list by the cursor.

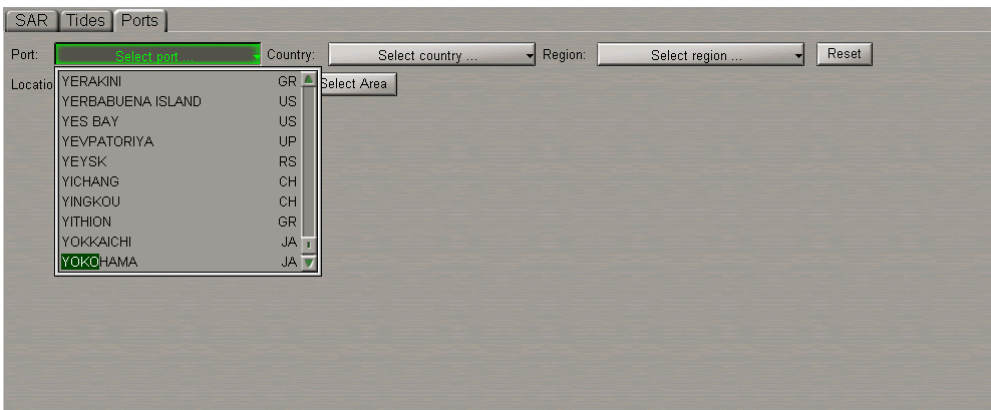

Press left trackball button or <Enter> key. The information on the selected port will be displayed on the page.

Read the necessary information (see document *Multi-Functional Display (v. 3.00.340). Functional Description, Chapter 7, section Ports*). For obtaining information on other port, press Reset button and repeat procedure.

Obtaining Information by the Region Name

Press Region button. Type the first letters of required region or select it from list by the cursor.

Press left trackball button or <Enter> key. Press Port button. In this case, the list displays ports belonging to selected region. Type the first letters of port name or select the port from list by the cursor.

Press left trackball button or <Enter> key. The information on the selected port will be displayed on the page.

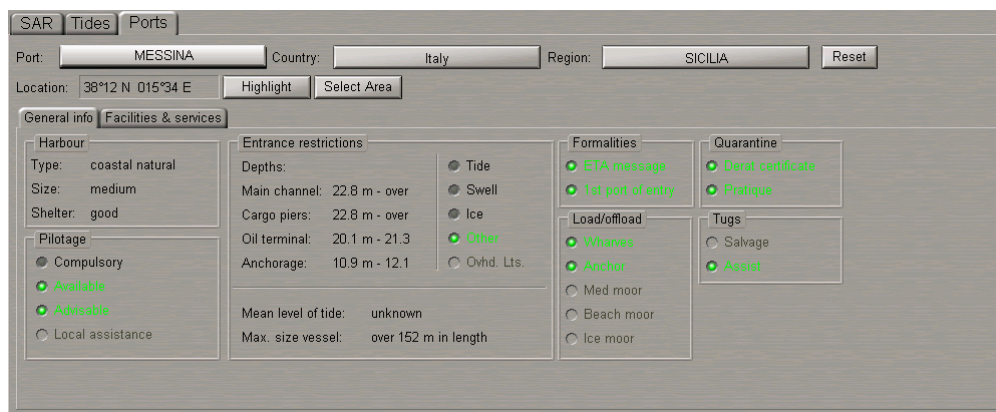

Read the necessary information (see document *Multi-Functional Display (v. 3.00.340). Functional Description, Chapter 7, section Ports*). For obtaining information on other port, press Reset button and repeat procedure.

Obtaining Information by the Country Name

Press Country button. Type the first letters of required country or select it from list by the cursor.

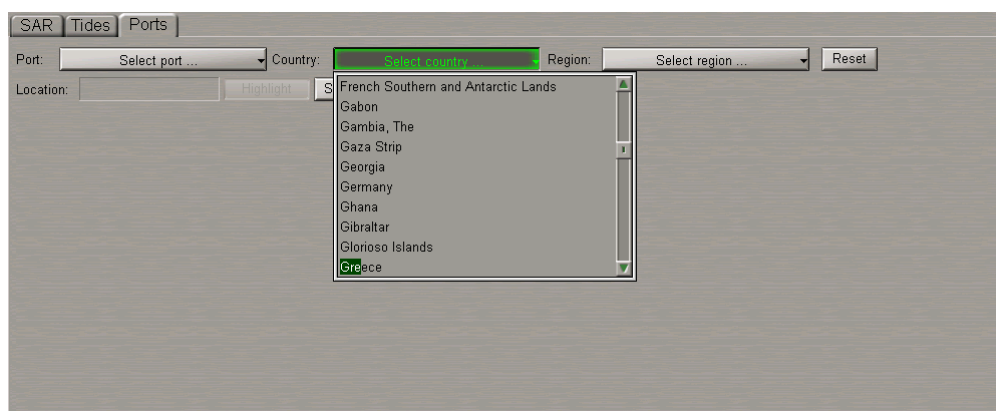

Press the left trackball button or <Enter> key. Press Port button. In this case, the list displays ports belonging to selected country. Type the first letters of port name or select the port from list by the cursor.

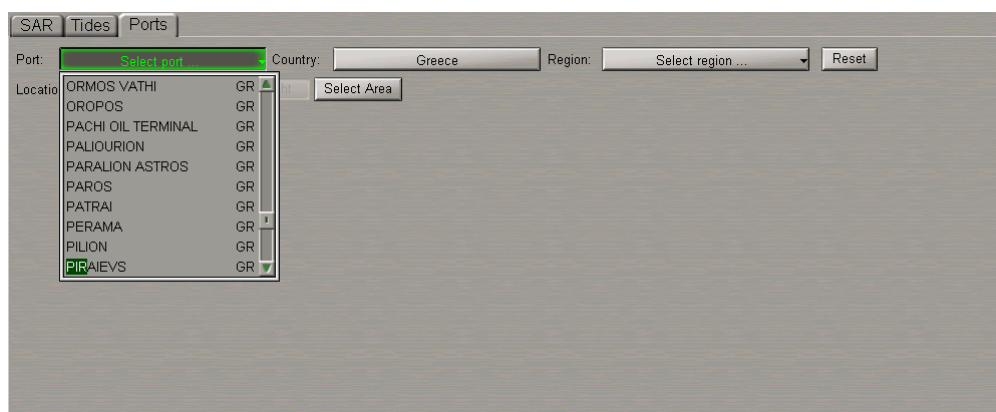

Press left trackball button or <Enter> key. The information on the selected port will be displayed on the page.

SAR Tides Ports			
Port:	PIRAIEVS	Country:	Greece
		Region:	GREECE EAST COAST
Location:	37°56 N 023°39 E	Highlight	Select Area
<div style="display: flex; justify-content: space-between;"> General info Facilities & services </div>			
Harbour Type: coastal breakwater Size: large Shelter: excellent	Entrance restrictions Depths: Main channel: 22.8 m - over Cargo piers: 9.4 m - 10.6 m Oil terminal: 9.4 m - 10.6 m Anchorage: 10.9 m - 12.1	Formalities <input checked="" type="checkbox"/> ETA message <input checked="" type="checkbox"/> 1st port of entry Load/offload <input checked="" type="checkbox"/> Wharves <input checked="" type="checkbox"/> Med moor <input type="checkbox"/> Anchor <input type="checkbox"/> Beach moor <input type="checkbox"/> Ice moor	Quarantine <input checked="" type="checkbox"/> Derat certificate <input type="checkbox"/> Pratique Tugs <input checked="" type="checkbox"/> Salvage <input checked="" type="checkbox"/> Assist
Pilotage <input checked="" type="checkbox"/> Compulsory <input checked="" type="checkbox"/> Available <input checked="" type="checkbox"/> Advisable <input type="checkbox"/> Local assistance	Tide <input type="checkbox"/> Swell <input type="checkbox"/> Ice <input checked="" type="checkbox"/> Other <input type="checkbox"/> Ovh'd. Lts. Mean level of tide: unknown Max. size vessel: over 152 m in length		

Read the necessary information (see document *Multi-Functional Display (v. 3.00.340). Functional Description, Chapter 7, section Ports*). For obtaining information on other port, press Reset button and repeat procedure.

Obtaining Information by the Cursor Position on the Chart Panel

Press Select Area button. Position the graphic cursor, which will appear, in the corner of the required chart area.

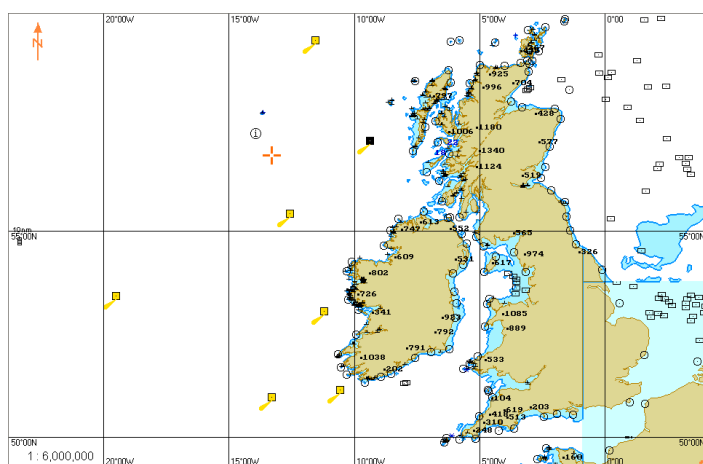

Press the left trackball button. Select the required chart fragment by moving the cursor with the trackball.

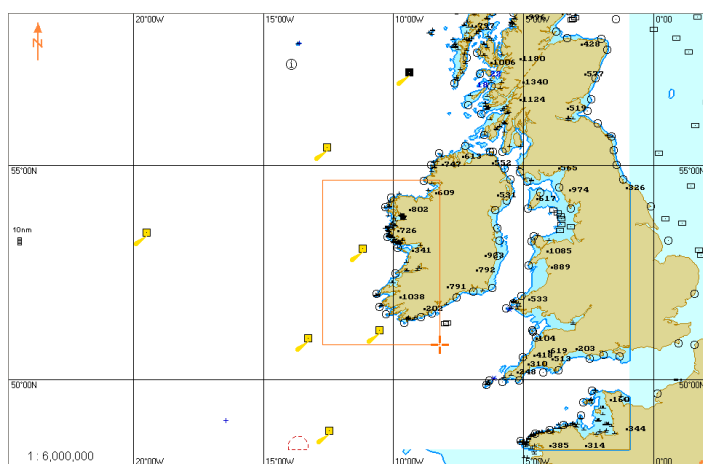

Press the left trackball button to exit from the graphic cursor mode. Press Port button. In this case, the list displays ports belonging to selected area. Type the first letters of port name or select the port from list by the cursor.

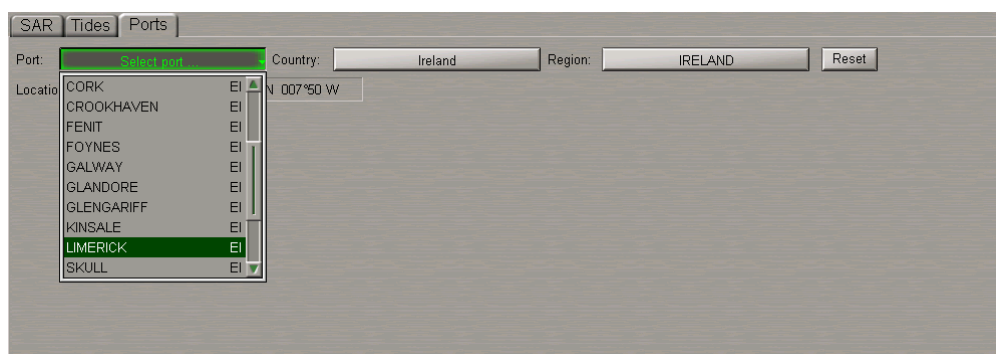

Press left trackball button or <Enter> key. The information on the selected port will be displayed on the page.

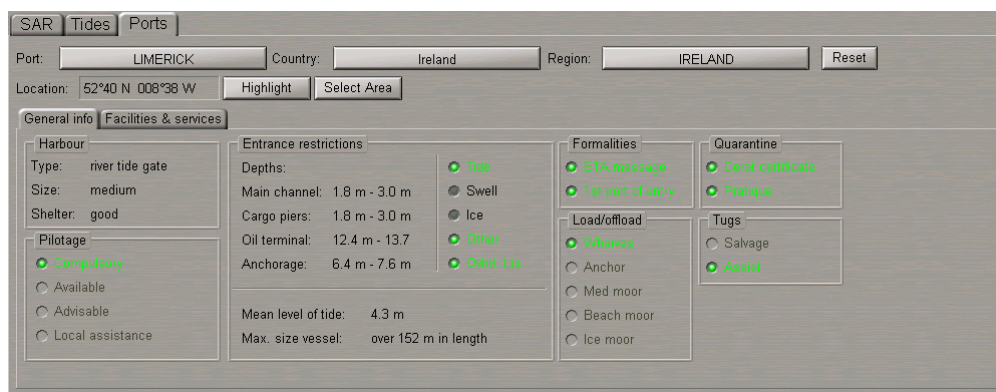

Read the necessary information (see document *Multi-Functional Display (v. 3.00.340). Functional Description, Chapter 7, section Ports*). For obtaining information on other port, press Reset button and repeat procedure.

Quick Search for Selected Port

Select the necessary port as described above. Press Highlight button.



The selected target will be displayed in the center of the Chart panel highlighted with a flashing circle.

Obtaining NAVTEX Information

Open the **Navtex** panel by selecting the appropriate item of the **Tasks List** menu in the tabs zone of the ECDIS task screen.

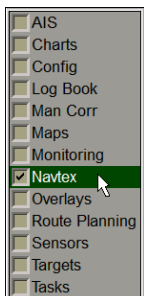

See document *Multi-Functional Display (v. 3.00.340). Functional Description, Chapter 7, section NAVTEX Messages.*

The screenshot shows the 'Navtex Out Monitor' interface. At the top, there are buttons for 'Update Database', 'Navtex Out Monitor', 'Delete', and 'Delete till: 12-12-15 11:27'. Below these are filter settings: 'Filter: ON Stations Subjects Max error rate = 100%' and a 'Find' button. The main area contains a table of messages:

Date Time	Stn	Subj	Serial Num.	Text	Err Rate	Status
07.09.11 21:23:30	I	B	84	071800 UTC SEP BALTIC SEA HETEO WARNINGS	7 %	
09.09.11 05:24:25	I	A	30	090340 UTC SEP DAN*SH NAV WARN 297	2 %	
09.09.11 05:25:11	I	A	29	081919 U°C SEP	1 %	
09.09.11				25000 UTC AUG		

Below the table, the details for the selected message (090340 UTC SEP) are shown:

Received: 09.09.11
 Subject: A - navigational warning Station: I
 090340 UTC SEP
 DAN*SH NAV WARN 297
 THE SOUND
 THE LIGHT MIDDELGRUNDS FORT W IS UNLIT. **N 55-43.3 N 012-39.9 E

On the right side, there are options for 'Polygon', 'Examined', 'Danger' (selected), and 'Protected'. Below these is a table for coordinates:

	Latitude	Longitude
1	55° 43.300 N	012° 39.900 E

Buttons for 'Add', 'Delete', and 'Highlight' are at the bottom right.

Work with NAVTEX Message Database

NAVTEX messages from the database are shown in the Message Table, filter settings taken into account.

The screenshot shows the 'Navtex Out Monitor' interface with a different set of filter settings: 'Filter: ON Stations Subjects Max error rate = 100%'. The 'Delete till' is set to '10-12-06 08:18'. The message table is as follows:

Date Time	Stn	Subj	Freq	Serial Num.	Text	Err. Rate	Status
22.11.06 11:29:24	C	L	490	34	131730 UTC NOV 06 UKRAINE COASTAL WARNING 613/06 ODESA	0 %	
22.11.06 11:29:34	C	L	490	30	101520 UTC NOV 06 *UKRAINE* COASTAL WARNING 609/06 ODESA	14 %	
22.11.06 11:29:44	C	L	490	15	031430 UTC NOV 06 UKRAINE COASTAL WARNING *TJ**EZ**ZESA	1 %	
22.11.06 11:29:44	C	L	490	7	*****.75;.9= 06 UKRAINE COASTAL WARNING 575/06 ODESA	3 %	
22.11.06 11:29:44	C	L	490	6	010900 UTC NOV 06 UKRAINE COASTAL WARNING 575/06 ODESA	2 %	

The Message Table contains the following message parameters fields:

- **!** – “Danger” message attribute or empty field (set automatically on the messages containing coordinates);
- **Date/Time** – message reception date/time (UTC from MFD);
- **Subj** – message subject (identifiers are taken from the message);
- **Freq** – frequency (kHz) which the message was received on (for the NMEA NAVTEX only);
- **Serial Num.** – message number from the NAVTEX message;
- **Text** – the first two lines of a NAVTEX message;
- **Err. Rate** – message reception error transmitted by the NAVTEX receiver for NMEA NAVTEX or calculated by MFD for ASCII NAVTEX;
- **Status** – message status (“Protected” or empty field).

For the message sorting by one of parameters, press the appropriate button with the column name in the Message Table (see document *Multi-Functional Display (v. 3.00.340). Functional Description, Chapter 7, section NAVTEX Messages*).

To turn on the filter, press the **ON** button in the **Filter** row:

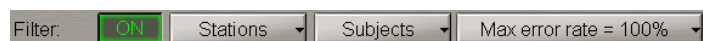

To make the filter settings, press the **Stations** button. The **All** checkbox is checked by default, and the Message Table shows messages from all the stations. Check the checkboxes of stations, whose messages should be displayed in the Message Table. The Message Table will display NAVTEX messages from the specified stations regardless of the NAVAREA area:

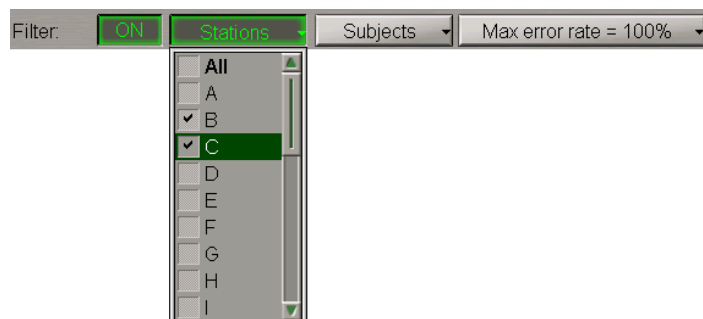

Use a similar procedure to make settings for messages filtration by the following parameters:

- **Subjects** – if message subjects from the offered list are checked, messages with these subjects are displayed. In this case, it is impossible to turn off displays with message subjects A, B, D and L (see document *Multi-Functional Display (v. 3.00.340). Functional Description, Chapter 7, section NAVTEX Messages, paragraph NAVTEX Messages Database*);

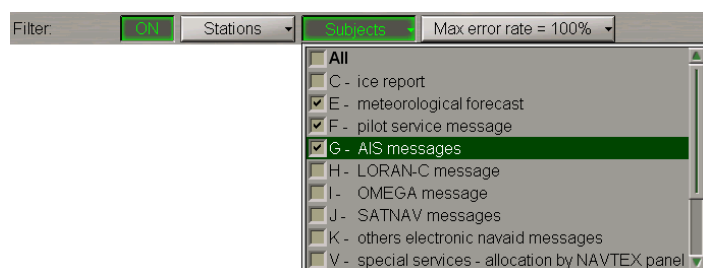

- **Max error rate** – messages whose reception error rate exceeds the set value are not displayed. Setting of the maximum error rate at 100% means the display of all the messages.

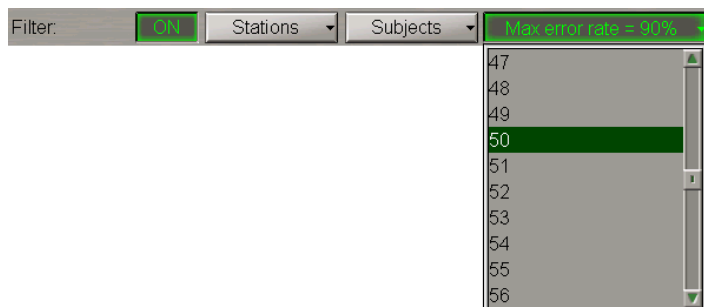

The Message Table will display messages to match all the three settings (see document *Multi-Functional Display (v. 3.00.340). Functional Description, Chapter 7, section NAVTEX Messages*).

To promptly find a message in the NAVTEX message table, corresponding to the NAVTEX message symbol on the Chart panel, press the **Find** button in the top right corner of the panel.

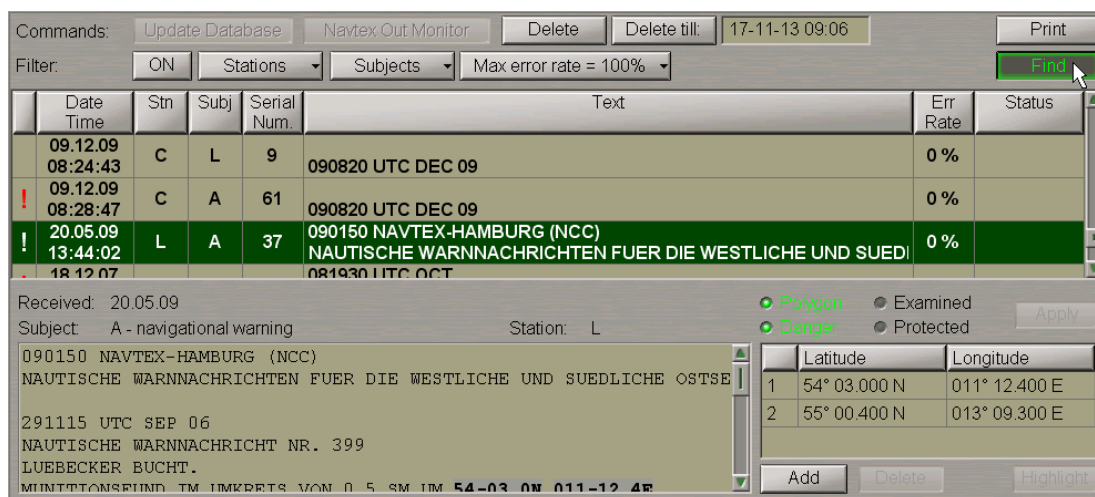

Position the acquisition marker which will appear on the Chart panel on the necessary NAVTEX message symbol.

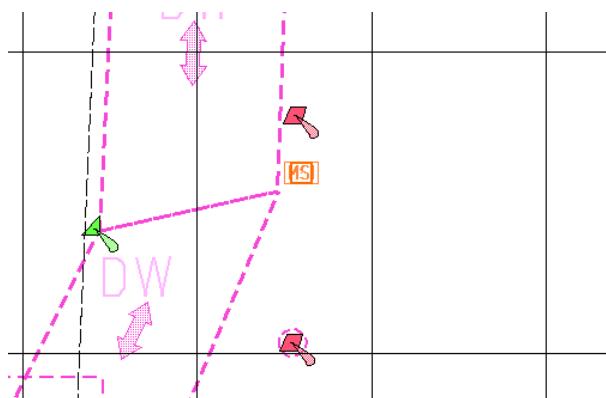

Press the left trackball button.

The NAVTEX message corresponding to this symbol will be shown in the table with appropriate highlighting.

Commands: Update Database Navtex Out Monitor Delete Delete till: 17-11-13 09:06 Print

Filter: ON Stations Subjects Max error rate = 100% Find

Date Time	Stn	Subj	Serial Num.	Text	Err Rate	Status
11.09.11 05:24:56	I	A	34	091349 UTC SEP DANISH NAV WARN 3*1	3 %	
18.01.09 20:53:18	J	A	90	301158 UTC NOV	0 %	
20.05.09 13:44:24	D	A	31	2809 1315UTC SPTEMBER 06 ISTANBUL TURK RADIO	0 %	Protected
18.11.09						

Received: 18.01.09
Subject: A - navigational warning Station: J

301158 UTC NOV
POLISH NAV WARN 191
POMORSKA BAY.
ORDNANCE CLEARANCE OPERATIONS 01-02 DEC 0700-1500 UTC.
DANGEROUS AREA:
53-55 7N 014-13 6E

Latitude Longitude

1	53° 55.700 N	014° 13.600 E
2	53° 59.300 N	014° 14.500 E
3	54° 02.200 N	014° 20.000 E

Add Delete Highlight

To update the NAVTEX message database, press the **Update Database** button.

Note: The database is updated automatically at a rate (5 to 60 minutes) set in the System Configuration utility at the time of installation (see document *Multi-Functional Display (v. 3.00.340). Installation Guide Part I, Chapter 2, section MFD Configuration, paragraph MFD Settings*).

Press **Navtex Out Monitor** to receive messages from the NAVTEX receiver without taking into account the filter set in the receiver.



Attention! The **Navtex Out Monitor** button should always be depressed. As filter settings are changed in the NAVTEX receiver, the button will be released, and it is necessary to press it again.

To delete one or several messages from the database, select them with the cursor in the Message Table. To select several messages required to be deleted, select them keeping <Ctrl> key depressed. To select several messages in a row, specify the first and the last message keeping <Shift> key depressed.

Date Time	Stn	Subj	Freq	Serial Num.	Text	Err. Rate	Status
21.11.06 08:28:23	A	A	490	47	311822 LMT EKIM 06 SAMSUN TURK RADIO	1 %	
21.11.06 08:28:48	A	A	490	36	090800 HAZ06 SAMSUN TURK RADIO	1 %	
21.11.06 08:28:58	A	A	490	30	091729 LMT EKIM 06 SAMSUN TURK RADIO	1 %	
21.11.06 08:28:58	B	L	490	68	260900 UTC OCT 06 *7(4-9,3 :9-5-) 2-4,8, 566/06 KERCH*	11 %	
21.11.06					131845 UTC NOV 06		

Press the **Delete** button: messages will be deleted.

To delete messages received before some certain moment of time, position the cursor in the input window to the right of the **Delete till** button and make a double click on the left trackball button.

Commands: Update Database Navtex Out Monitor Delete Delete till: 10-12-06 10:11 Print

Filter: ON Stations Subjects Max error rate = 100%

Set the required value by rolling the trackball, or enter it from the keyboard. Press the right trackball button and select **Apply**.

Commands: Update Database Navtex Out Monitor Delete Delete till: 22-11-06 11:28 Apply Print

Filter: ON Stations Subjects Max error rate = 100%

Press the **Yes** button to confirm the deleting of messages.

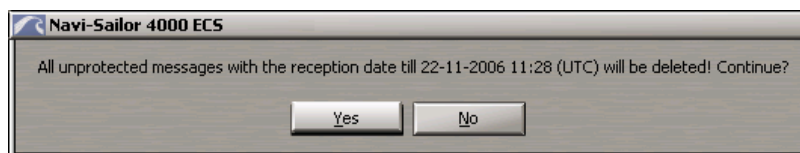

Messages will be deleted.

Note: If a message has the “Protected” status, the **Delete** button will be inactive, and you will not be able to delete the message from the database. When several messages are deleted, messages with the “Protected” status will not be deleted.

To print out one or several messages from the database, select them with the cursor in the Message Table in the manner specified above, and press the **Print** button.

Work with Messages

To work with messages, use the bottom part of the **Navtex** panel. Use the cursor to select the necessary message in the Message Table, the text of the message will be shown in the bottom part of the **Navtex** panel.

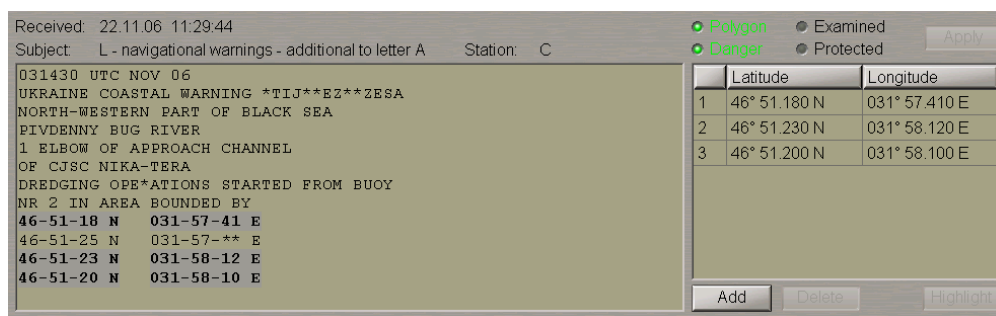

Setting NAVTEX Message Status and Attributes

Check the **Examined** **Examined** checkbox to change the message status to “Examined”. This means that the user has read the NAVTEX message. NAVTEX message symbols from a message with the “Examined” status will be displayed on the ECDIS task screen in the following form: **MSI**.

Check the **Protected** **Protected** checkbox to change the message status to “Protected”. This means that the user will not be able to delete this NAVTEX message.

The “**Danger**” **Danger** attribute is set by default if there is at least one pair of valid coordinates in the NAVTEX message.

Check the **Polygon** **Polygon** checkbox to set the “Polygon” attribute. This is only possible for the messages in which more than one pair of valid coordinates is available.

After making all the settings, press the activating **Apply** button (see document *Multi-Functional Display (v. 3.00.340). Functional Description, Chapter 7, section NAVTEX Messages*).

Editing Coordinates in NAVTEX Message

1. Position the cursor on the coordinates which should be edited, in the right bottom box of the **Navtex** panel and make a double click on the left trackball button.

	Latitude	Longitude
1	46°51.180 N	031° 57.410 E
2	46° 51.230 N	031° 58.120 E
3	46° 51.200 N	031° 58.100 E

Set the required value by rolling the trackball, or enter it from the keyboard. Press the right trackball button and select **Apply**.

	Latitude	Longitude
1	46°51.190 N	031° 57.410 E
2	46° 51.230 N	031° 58.120 E
3	46° 51.200 N	031° 58.100 E

Press the left trackball button again: the edited value will be set. The coordinate value in the window is shown in italic indicating that the field has been edited by the user.

	Latitude	Longitude
1	<i>46° 51.190 N</i>	031° 57.410 E
2	46° 51.230 N	031° 58.120 E
3	46° 51.200 N	031° 58.100 E

- To add a new NAVTEX message symbol, position the cursor on the symbol coordinates, which will be followed by the new symbol coordinates in the table (this is important for the subsequent setting of the "Polygon" attribute) and press the left trackball button. Press the **Add** button. A new line containing the same coordinates as the old ones will be displayed.

	Latitude	Longitude
1	<i>46° 51.190 N</i>	<i>031° 57.410 E</i>
2	46° 51.190 N	031° 57.410 E
3	46° 51.230 N	031° 58.120 E
4	46° 51.200 N	031° 58.100 E

Edit the coordinates as described above. The new coordinate values in the window are shown in italic indicating that the field has been edited by the user.

- To delete a NAVTEX message symbol, position the cursor on its coordinates and press the left trackball button.

	Latitude	Longitude
1	46° 51.190 N	031° 57.410 E
2	<i>46° 51.190 N</i>	<i>031° 57.410 E</i>
3	46° 51.230 N	031° 58.120 E
4	46° 51.200 N	031° 58.100 E

Press **Delete** button.

	Latitude	Longitude
1	<i>46° 51.190 N</i>	<i>031° 57.410 E</i>
2	46° 51.230 N	031° 58.120 E
3	46° 51.200 N	031° 58.100 E

The NAVTEX message symbol coordinates will be deleted from the table.

After making the changes, press the **Apply** button which will be activated.

Fast Search for NAVTEX Message Symbol on the Chart Panel

Position the cursor on the coordinates of the NAVTEX message symbol which should be found and press the left trackball button.

	Latitude	Longitude
1	46° 51.180 N	031° 57.410 E
2	46° 51.230 N	031° 58.120 E
3	46° 51.200 N	031° 58.100 E

Press Highlight button.

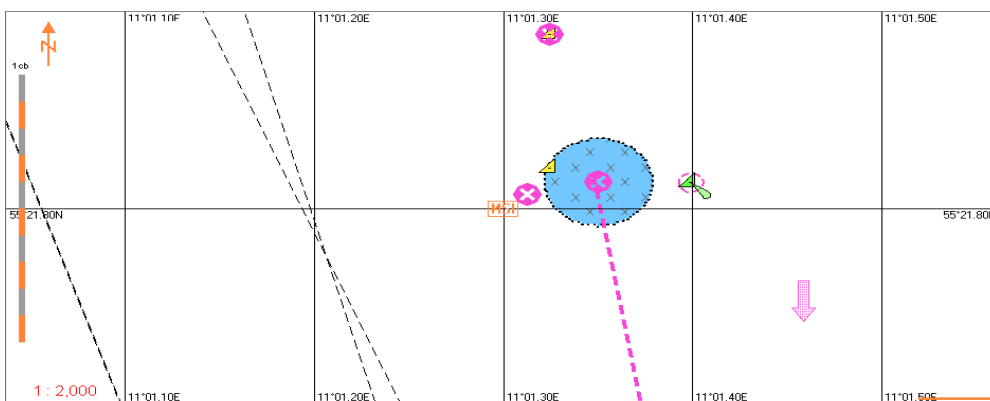

The selected target will be displayed in the centre of the Chart panel, highlighted with a flashing circle.

Obtaining Information on Own Ship AIS Data

Press the button with the name of the set display in the **Display Panel** window of the Control panel.

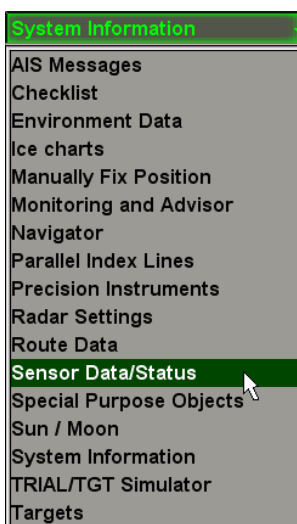

In the list, which will open up, select **Sensor Data/Status** line and press the left trackball button.

Use the tab in the top part of the **Sensor Data/Status** display panel which will open up, to switch to the **AIS VDL Data** page.

Sensor Data/Status	
Primary Status	AIS VDL Data
Source	Int (D-GPS)
UTC	Status OK
Latitude	50° 01.092 N
Longitude	000° 59.656 E
COG	035.4°
SOG	12.0 kn
HDG	035.0°
ROT	12° /min port

AIS VDL Data display is intended for the display of data broadcast by the transponder. The display contains the following data:

- **Source** – current positioning system used by the transponder: Internal **Int** or External **Ext (D-GPS)**; the display of the positioning system indicator in the green colour means that the RAIM (Receiver Autonomous Integrity Monitoring) GNSS receiver is in use;
- **UTC** – UTC synchronising status in the AIS transponder; it is determined strictly by the Internal GPS;
- **Latitude** – latitude value supplied by the positioning system used by the transponder;
- **Longitude** – longitude value supplied by the positioning system used by the transponder;
- **COG** – value of course over the ground supplied by the positioning system used by the transponder;
- **SOG** – value of speed over the ground supplied by the positioning system used by the transponder;
- **HDG** – heading value supplied to the transponder by the course detection (gyro) system;
- **ROT** – values of direction and rate of turn supplied to the transponder by the Rate-of-Turn sensor.

Obtaining Information on Currently License

Open **Config** panel by selecting the appropriate line of **Tasks List** menu in the tabs zone of the ECDIS task screen.

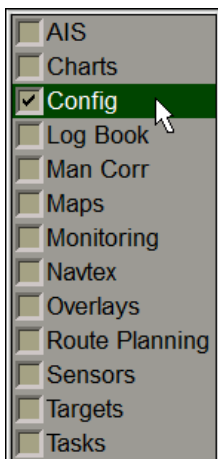

Use the tab in the top part of **Config** panel, which will open up, to switch to **License Info** page.

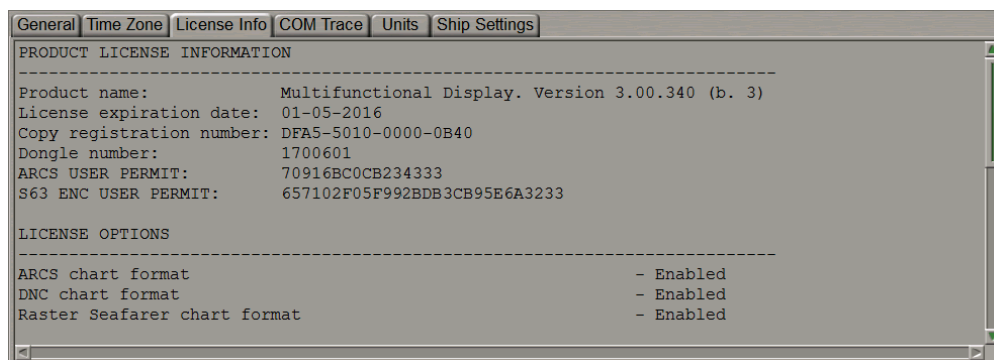

License Info page is intended for the display of data on the MFD software product license and the functions allowed to be used (licensed). This page also specifies the installed MFD version. For update license see document *Multi-Functional Display (v. 3.00.340). Utilities, Chapter 8*.

Obtaining Information on Input/Output Messages

Open **Config** panel by selecting the appropriate line of **Tasks List** menu in the tabs zone of the ECDIS task screen.

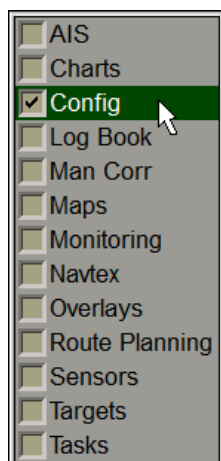

Use the tab in the top part of **Config** panel, which will open up, to switch to **COM Trace** page.

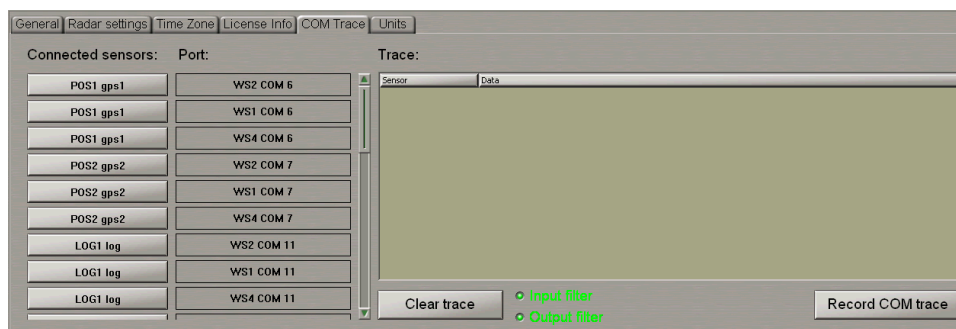

This page is intended for displaying and recording of the IEC 61162-1, 61993-2, and proprietary formats and similar text messages/sentences provided to the MFD from the external sensors and displaying of the sentences transmitted by the MFD to the external devices.

The page contains the following elements:

- **Connected sensors** – group of buttons corresponding to the external devices connected via the System Configuration utility (see document *Multi-Functional Display (v. 3.00.340). Installation Guide Part 1, Chapter 2, section MFD Configuration*, paragraph *Sensors Settings*); the buttons allow selection of a sensor or external device, which the exchange of messages with is shown on the data display window;
- **Port** – group of indicators of the MFD COM ports, which the sensors and external devices are connected to;
- **Clear trace** – to clear display window;
- **Input filter** – to turn on the display of messages supplied to the MFD from the external sensors;
- **Output filter** – to turn on the display of messages transmitted by the MFD to the external devices;
- **Record COM trace** – recording of the message stream from all the WS COM ports to `comtrace._____file`;
- **Data display window:**
 - **Sensor** – direction and source of the message stream;
 - **Data** – messages.

Display of Data Flow Between the MFD and Different External Devices

To display the traffic between the MFD and the necessary external device, press the button with the name of this device in the **Connected sensors** column.

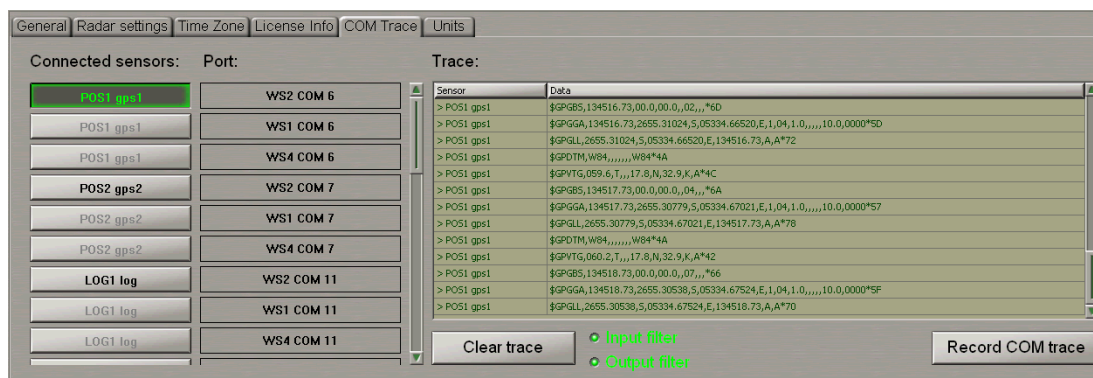

The data flow will be shown in the **Trace** window. The **Input filter** and **Output filter** checkboxes are turned on by default, so the **Trace** window shows the flow of both incoming and outgoing MFD data. To display the data flow in one direction only, turn off the pertinent filter.

Note: You can simultaneously monitor the data flow from several external devices by pressing the appropriate buttons.

To clear the **Trace** window, press the **Clear trace** button.

COM Trace Record



Attention! For each WS, a `comtrace._____` file can be recorded for the COM ports of this WS only.

Press the Record COM trace button.

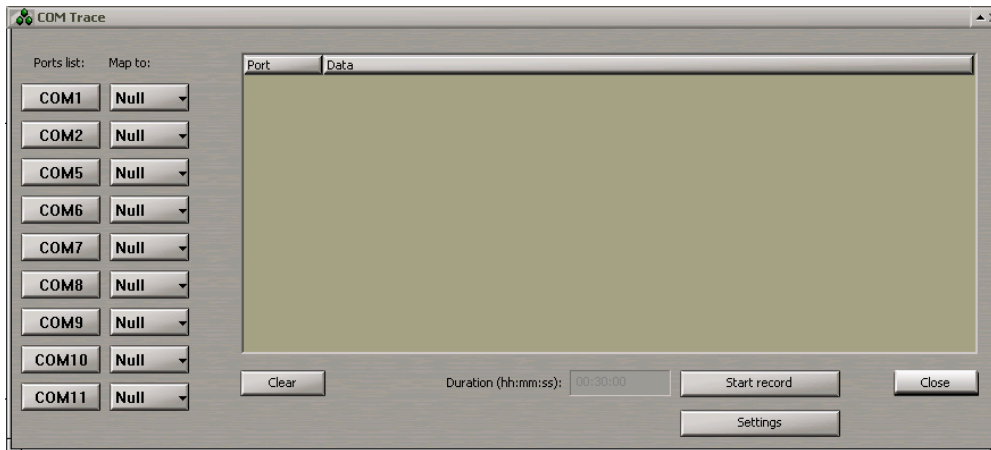

In the **COM Trace** window which will open up, the **Ports list** column contains all the connected COM ports of the WS in question. Next to the port which the message stream should be recorded to `comtrace._____` file for, press the button in the **Map to** column.

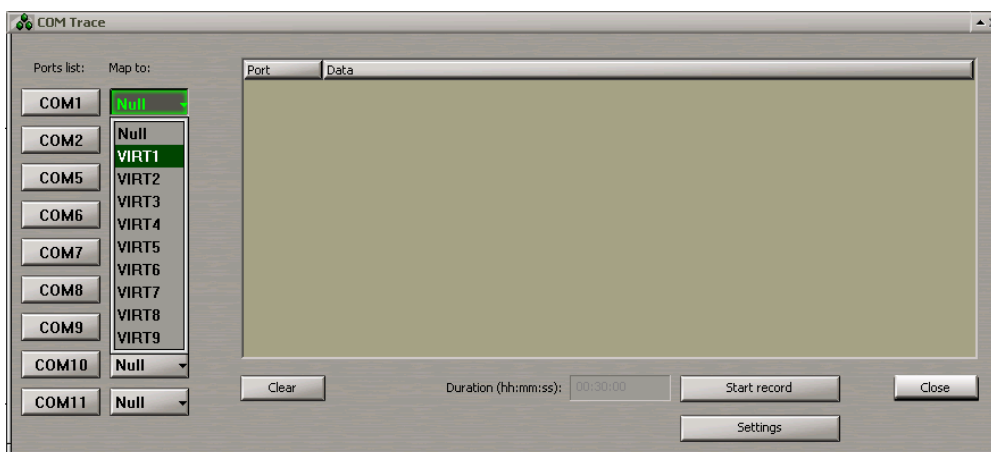

From the pull-down list, select the virtual VIRTX port for the given COM port.

Note: For each COM port, an individual VIRT port should be selected.

For each COM port which the `comtrace._____` file will be recorded for (e.g. COM1, COM5 and COM8), set the corresponding virtual port (VIRT1, VIRT2 and VIRT3).

In the **Ports list** column, press the buttons with the names of the ports which the `comtrace. _____` file will be recorded for: the data flow will be shown in the data display window. Press the **Start record** button.

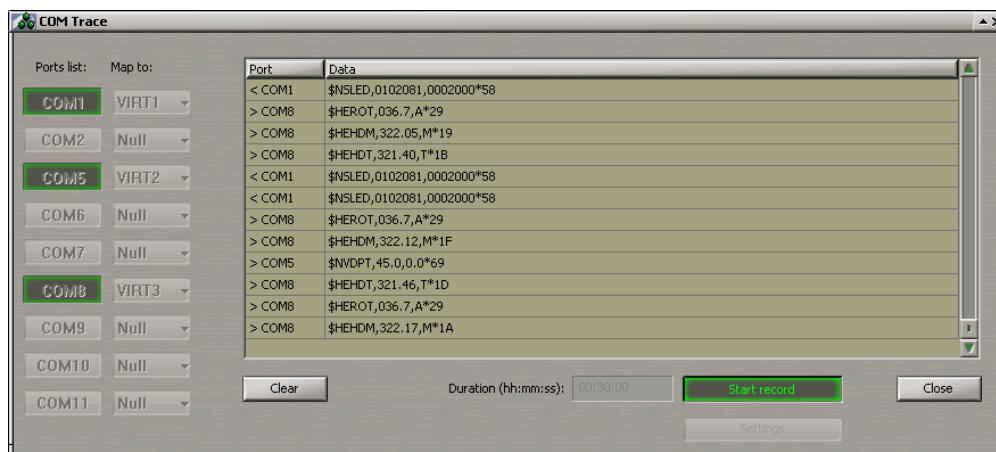

The `comtrace. _____` file recording will be made from all the turned on COM ports during the time specified in the **Duration** window (30 minutes by default). If it is necessary to interrupt the recording, press the **Start record** button again. After the end of the recording, the **Start record** button will be automatically disabled.

For the further use, copy the `comtrace. _____` file from the `C:\Transas\ComTrace.FA` directory onto the external carrier by using the Data Tool utility (see document *Multi-Functional Display (v. 3.00.340). Utilities, Chapter 2, section Software Description, paragraph Data Tool Utility Window, under Internal Group*).

Note: When a new `comtrace. _____` file is recorded, the old file in the `C:\Transas\ComTrace.FA` directory will be rewritten.

To clear the data display window, press the **Clear** button.

To close the COM Trace window, press the **Close** button.

For additional settings of the `comtrace. _____` file recording, press the **Settings** button.

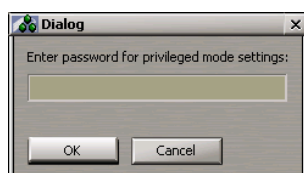

Press the **OK** button.



Note: With the use of the password by the service engineer, more advanced settings of the `comtrace. _____` file recording can be made, normally unavailable to the ordinary user remaining grayed.

Press the **OK** button.

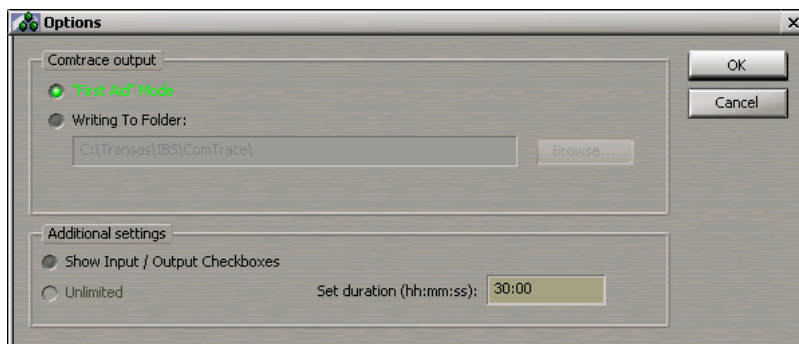

To record the file direct to onto the external carrier, press the **Writing To Folder** button and specify the path to the external carrier.

To display the buttons for turning on the filter for the input/output messages when recording the `comtrace._____` file, in the **Options** window check the **Show Input/Output Checkboxes**.

In the **Set duration** input window, set the duration of recording the `comtrace._____` file (not more than 30 min).

Multi-Functional Display

ECDIS User Manual

Version: 3.00.340

Transas MIP Ltd.

Phone: +46 31 769 56 00.

E-mail: info@transas.com

24/7 Support: +46 771 460 100

WEB: www.transas.com

The logo for Transas, featuring the word "TRANSAS" in a bold, red, stylized font. The letters are interconnected, with the 'T' and 'R' having a unique, blocky design. The 'S' at the end is also stylized, with a horizontal bar that extends to the right.