

MERCHANT MARINE ACADEMY OF MACEDONIA

SCHOOL OF ENGINEERS

PROJECT IN ENGLISH: DESCRIPTION AND USE OF VARIOUS PROPULSION SYSTEMS IN VESSELS



STUDENT: Lemonidis-Manthos Zisis

ΑΓΜ: 4262

DELIVERY DATE:

SUPERVISOR: Papadopoulou Anna

ABSTRACT

The purpose of this project is to give the reader the essential knowledge about propulsion systems in vessels. In the next chapters there will be an analysis, of what a propulsion system is, what the parts of a propulsion system consist of, the main power of propulsion systems (what kind of engines and motors are used for ship propulsion) how a propulsion system works, and what does every part of those systems do. Then in the following chapters there will be a display of the types of propellers that are used in marine propulsion systems and the disadvantages of propeller usage and the equipment that the systems have (the mechanical parts that stand between the engine-motor and the propeller). Next there will be information on diesel-electric propulsion and the steerable azimuth system. Finally, we will look into the experimental propulsion systems (systems that are under construction) that are getting developed, and there will be a small layout for the propulsion systems that various vessels are using (demonstrating what kind of engines the vessels are using).

ΠΕΡΙΛΗΨΗ

Ο στόχος αυτής της εργασίας είναι να δώσει στον αναγνώστη την γνώση για τα συστήματα προώσεως στα πλοία. Στα επόμενα κεφάλαια θα αναλυθεί, τι είναι το σύστημα προώσεως, ποια είναι τα μέρη του, η κινητήριος δύναμη των συστημάτων αυτών (δηλαδή τις μηχανές και τους κινητήρες που χρησιμοποιούνται στα συστήματα προώσεως των πλοίων) και έτσι κατά συνέπεια θα εξηγηθεί πως δουλεύει το σύστημα και τι κάνει κάθε μέρος του συστήματος. Στα επόμενα κεφάλαια θα παρουσιαστούν οι τύποι των ελίκων που έχουμε στην θαλάσσια πρόωση, το πρόβλημα που δημιουργείται, κατά την λειτουργία της και ο εξοπλισμός που έχουν τα συστήματα. Στην συνέχεια θα παρουσιαστούν τα κεφάλαια της ηλεκτροδιζελοκίνητης πρόωσης και της πρόωσης «χωρίς τιμόνι» . Και στο τέλος θα αναφερθούν τα πειραματικά συστήματα προώσεως που αναπτύσσονται (συστήματα που είναι υπό κατασκευή) και θα υπάρξει μια μικρή παρουσίαση για τα συστήματα που χρησιμοποιούν διάφορα πλοία (τι μηχανές χρησιμοποιούνται απο τα πλέον γνωστά πλοία).

INTRODUCTION

Marine propulsion is the mechanism or system used to move a ship or boat across water. While paddles and sails are still used on some smaller boats, most modern ships are propelled by mechanical systems consisting of a motor or engine turning a propeller, or less frequently, in jet drives, an impeller. Marine engineering is the discipline concerned with the design of marine propulsion systems.

The main engine of a ship is connected to its propeller with the help of a shaft. This whole system, along with other vital machineries is known as the ship propulsion system. The type of propulsion system used in a ship depends on several factors such as speed, power, ship type etc.

Steam engines were the first mechanical engines used in marine propulsion, but have mostly been replaced by two-stroke or four-stroke diesel engines, outboard motors, and gas turbine engines on faster ships. Nuclear reactors producing steam are used to propel warships and icebreakers, and there have been attempts to utilize them to power commercial vessels. Electric motors have been used on submarines and electric boats and have been proposed for energy-efficient propulsion.¹

¹ Basic ship propulsion by J.P GHOSE and R.P GORKAN 2004, published by Allied Publishers Pvt. Limited (pages 1-3)

CHAPTER 1

PROPULSION SYSTEMS IN GENERAL

The choice of the appropriate propulsion system for a specific vessel is a very complicated procedure that requires knowledge and experience.

To show how important is the right choice of the propulsion system, it has to be noted that the cost of the facility may reach the 25% of the ship's total cost. However the cost of the operation will be more than 20 times the cost of the facility, because the cost of the operation in 2 years is going to be equal with the cost of the facility.

It is obvious that the choice of a propulsion system with low operation cost is more important than a choice of a system with low cost of construction. Of course, the cost of the operation is not the only criterion for choosing the most appropriate system for the ship we are interested in.

The main requirements, that have to do with the propulsion system, are the following:

- It must occupy the least possible space and have the least possible weight.
- The cost for its function and maintenance should be the least possible.
- It must be able to consume low quality fuel oil, without major consequences on the reliability of the operation and the cost of maintenance.
- The facility must be as simple as it can be, for increasing reliability and reducing of the maintenance cost.
- The facility should be operating with small number of trained personnel.
- The facility must provide power to the propeller in the best way for the ship's design, in the most appropriate speed and torque.
- The construction cost must be the lowest possible.

Nowadays, technology and knowledge of propulsion systems are at a satisfying level, so there are plenty of choices. However it has to be noted, that the propulsion system for the ships are selected based on a specific «unwritten» protocol that has to do with the type of the ship. In the

following chapters the main propulsion systems will be displayed and the most popular system in marine propulsion.²

² Internal combustion engines volume 2 2008, published by Institute Eugenidou (pages 99-103)

CHAPTER 2

THE MAIN PARTS OF THE PROPULSION SYSTEMS

Mechanical propulsion systems generally consist of a motor or engine turning a propeller, or less frequently, an impeller or wave propulsion fins. Steam engines were first used for this purpose, but have mostly been replaced by two-stroke or four-stroke diesel engines, outboard motors, and gas turbine engines on faster ships. Nuclear reactors producing steam are used to propel warships and icebreakers, and there have been attempts to utilize them to power commercial vessels.

In addition to traditional fixed and controllable pitch propellers there are many specialized variations, such as contra-rotating and nozzle-style propellers. Most vessels have a single propeller, but some large vessels may have up to four propellers supplemented with transverse thrusters for manoeuvring at ports. The propeller is connected to the main engine via a propeller shaft and, in case of medium- and high-speed engines, a reduction gearbox. Some modern vessels have a diesel-electric power train in which the propeller is turned by an electric motor powered by the ship's generators.³

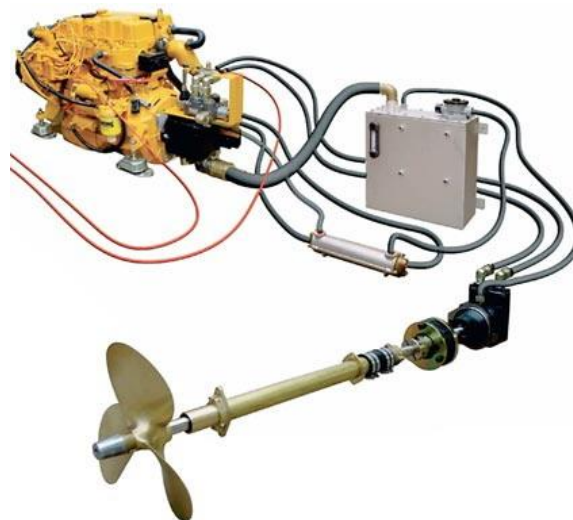

Image 2. 1 A small propulsion system (**BoatDesign.net**)

³ Basic ship propulsion by J.P GHOSE and R.P GORKAN 2004, published by Allied Publishers Pvt. limited

CHAPTER 3

HOW DOES A PROPULSION SYSTEM WORK

The primary function of any marine engineering plant is to convert the chemical energy of a fuel into useful work and to use that work for the Propulsion of the ship. A propulsion unit consists of the machinery, equipment, and controls that are mechanically, electrically, or hydraulically connected to a propulsion shaft. There are three main types of propulsion units used in the Navy, and the power is transmitted from the propulsion unit to the ship's propeller through the use of gears, shafts, and clutches.

A ship moves through the water by propelling to the direction that specific devices allow, such as paddle wheels or propellers. These devices impart velocity to a column of water and move it in the direction opposite to move the ship. A force, called reactive force because it reacts to the force of the column of water, is developed against the velocity imparting device. This force, also called thrust, is transmitted to the ship and causes the ship to move through the water. The screw-type propeller is the propulsion device used in almost all naval ships. The thrust developed on the propeller is transmitted to the ship's structure by the main shaft through the thrust bearing.

The main shaft extends from the main reduction gear shaft of the reduction gear to the propeller. It is supported and held in alignment by the spring bearings, the stern tube bearings, and the thrust bearing. The thrust, acting on the propulsion shaft as a result of the pushing effect of the propeller, is transmitted to the ship's structure by the main thrust bearing. In most ships, the main thrust bearing is located at the forward end of the main shaft within the main reduction gear casing. In some very large ships, however, the main shaft thrust bearing is located farther aft in a machinery space or a shaft alley.

The main reduction gear connects the prime mover (engine) to the shaft. The function of the main reduction gear is to reduce the high rotational speeds of the engine and allow the propeller to operate at lower rotation speeds. In this way, both the engine and the propeller shaft rotate at their most efficient speeds.⁴

⁴ Basic ship propulsion by J.P GHOSE and R.P GORKAN 2004, published by Allied Publishers Pvt. Limited (pages 1-3)

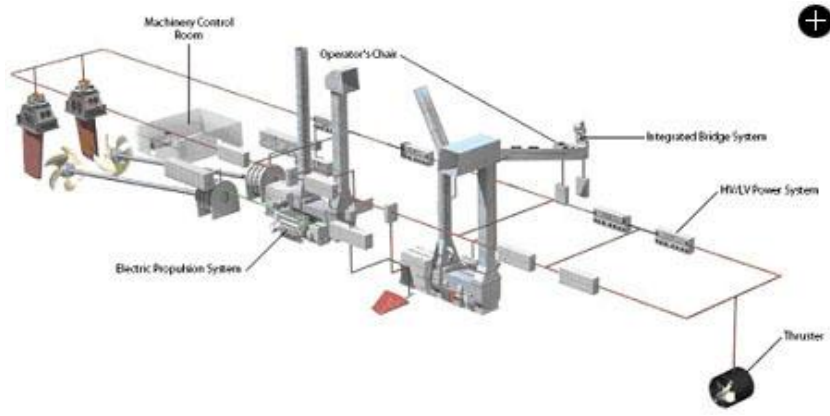

Image 3. 1 The structure of a propulsion system (**BoatDesign.net**)

CHAPTER 4

THE MAIN POWER IN PROPULSION SYSTEMS

4.1 RECIPROCATING STEAM ENGINES

The first engines, which worked in ships, were steam engines. A steam engine is a heat engine that performs mechanical work using steam as its working fluid. Steam engines are typically external combustion engines.

A wide variety of reciprocating marine steam engines developed over the course of the 19th century.

The two main methods of classifying such engines are by connection mechanism and cylinder technology.

Most early marine engines had the same cylinder technology (simple expansion,) but a number of different methods of supplying power to the crankshaft (i.e. connection mechanism) were in use. Thus, early marine engines are classified mostly according to their connection mechanism. Some common connection mechanisms were side-lever, steeple, walking beam and direct-acting.

However, steam engines can also be classified according to their cylinder technology (simple expansion, compound, annular etc.). One can therefore sometimes find examples of engines which were classified under both methods, such as the compound walking beam (compound being the cylinder technology and walking beam being the connection method). Over time, as most engines became direct-acting but cylinder technologies were growing more complex, engines began to be classified solely according to their cylinder technology instead.

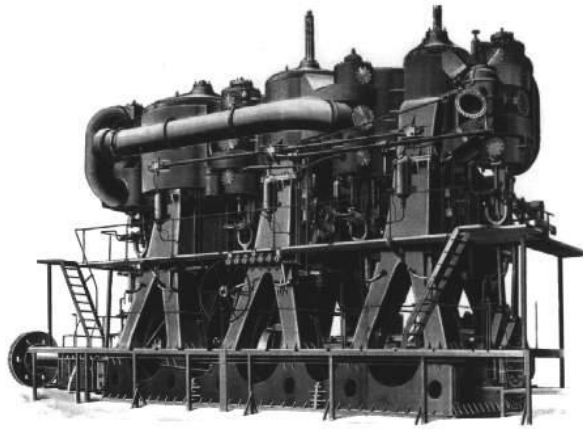

Image 4. 1 A reciprocating steam engine (Martin's Maritime Engineering Page)

4.2 RECIPROCATING DIESEL ENGINES

Most modern ships utilise a reciprocating diesel engine as their prime mover, due to their operating simplicity, robustness and fuel economy compared to most other prime mover mechanisms. The rotating crankshaft can be directly coupled to the propeller with slow speed engines, via a reduction gearbox for medium and high speed engines, or via an alternator and electric motor in diesel-electric vessels.

The reciprocating marine diesel engine first came into use in 1903 when the diesel electric river tanker Vandal was put in service by Branobel. Diesel engines soon offered greater efficiency than the steam turbine, but for many years had an inferior power-to-space ratio. The advent of turbo charging however hastened their adoption, by permitting greater power densities.

Diesel engines today are broadly classified according to:

4.2.1 Their operating cycle: two-stroke engine or four-stroke engine:

- Two-stroke engine: A two-stroke engine is an internal combustion engine that completes the process cycle in one revolution of the crankshaft (an up stroke and a down stroke of the piston, compared to twice that number for a four-stroke engine). This is accomplished by using the end of the combustion stroke and the beginning of the compression stroke to perform simultaneously the intake and exhaust (or scavenging) functions. In this way, two-

stroke engines often provide high specific power, at least in a narrow range of rotational speeds. The functions of some or all of the valves required by a four-stroke engine are usually served in a two-stroke engine by ports that are opened and closed by the motion of the piston(s), greatly reducing the number of moving parts. Gasoline (spark ignition) versions are particularly useful in lightweight (portable) applications, such as chainsaws, and the concept is also used in diesel compression ignition engines in large and weight insensitive applications, such as ships.

- Four-stroke engine: A four-stroke engine, also known as four-cycle, is an internal combustion engine in which the piston completes four separate strokes—intake, compression, power, and exhaust—during two separate revolutions of the engine's crankshaft, and one single thermodynamic cycle. The four cycles refer to intake, compression, combustion (power), and exhaust cycles that occur during two crankshaft rotations per power cycle of the four cycle engines. The cycle begins at Top Dead Centre (TDC), when the piston is farthest away from the axis of the crankshaft. A cycle refers to the full travel of the piston from Top Dead Centre (TDC) to Bottom Dead Centre (BDC). (See Dead centre.)

INTAKE stroke: on the intake or induction stroke of the piston, the piston descends from the top of the cylinder to the bottom of the cylinder, reducing the pressure inside the cylinder. A mixture of fuel and air, or just air in a diesel engine, is forced by atmospheric (or greater) pressure into the cylinder through the intake port. The intake valve(s) then close. The volume of air/fuel mixture that is drawn into the cylinder, relative to the volume of the cylinder is called, the volumetric efficiency of the engine.

COMPRESSION stroke: with both intake and exhaust valves closed, the piston returns to the top of the cylinder compressing the air, or fuel-air mixture into the combustion chamber of the cylinder head.

POWER stroke: this is the start of the second revolution of the engine. While the piston is close to Top Dead Centre, the compressed air–fuel mixture in a gasoline engine is ignited, usually by a spark plug, or fuel is injected into the diesel engine, which ignites due to the heat generated in the air during the compression stroke. The resulting massive pressure from the combustion of the compressed fuel-air mixture forces the piston back down toward bottom dead centre.

EXHAUST stroke: during the exhaust stroke, the piston once again returns to top dead centre while the exhaust valve is open. This action evacuates the burnt products of combustion from the cylinder by expelling the spent fuel-air mixture out through the exhaust valve(s).

4.2.2 Their construction: crosshead, trunk, or opposed piston

4.2.3 Their speed:

- Slow speed: any engine with a maximum operating speed up to 300 revolutions per minute (rpm), although most large two-stroke slow speed diesel engines operate below 120 rpm. Some very long stroke engines have a maximum speed of around 80 rpm. The largest, most powerful engines in the world are slow speed, two stroke and crosshead diesels.
- Medium speed: any engine with a maximum operating speed in the range 300-900 rpm. Many modern four-stroke medium speed diesel engines have a maximum operating speed of around 500 rpm.
- High speed: any engine with a maximum operating speed above 900 rpm.

Most modern larger merchant ships use slow speed, two stroke, crosshead engines, or medium speed, four stroke, trunk engines. Some smaller vessels may use high speed diesel engines.

The size of the different types of engines is an important factor in selecting what will be installed in a new ship. Slow speed two-stroke engines are much taller, but the footprint required, is smaller than that needed for equivalently rated four-stroke medium speed diesel engines. As space above the waterline is at a premium in passenger ships and ferries (especially ones with a car deck), these ships tend to use multiple medium speed engines resulting in a longer, lower engine room than that needed for two-stroke diesel engines. Multiple engine installations also give redundancy in the event of mechanical failure of one or more engines, and the potential for greater efficiency over a wider range of operating conditions.

As modern ships' propellers are at their most efficient at the operating speed of most slow speed diesel engines, ships with these engines do not generally need gearboxes. Usually such propulsion systems consist of either one or two propeller shafts with its own each, direct drive engine.

Ships propelled by medium or high speed diesel engines may have one or two (sometimes more) propellers, commonly with one or more engines driving each propeller shaft through a gearbox. Where more than one engine is geared to a single shaft, each engine will most likely drive through a clutch, allowing engines not being used to be disconnected from the gearbox while others keep running. This arrangement lets maintenance be carried out while under way, even far from port.



Image 4. 2 A two stroke diesel engine
([SeekPart.com](#))



Image 4. 3 A four stroke diesel engine ([Global Marine Services Co.Ltd.net](#))

4.3 STEAM TURBINES

A steam turbine is a mechanical device that converts thermal energy in pressurized steam into useful mechanical work. The original steam engine which largely powered the industrial revolution in the UK was based on reciprocating pistons. This has now been almost totally replaced by the steam turbine because the steam turbine has a higher thermodynamic efficiency and a lower power-to-weight ratio and the steam turbine is ideal for the very large power configurations used in power stations. The steam turbine derives much of its better thermodynamic efficiency because of the use of multiple stages in the expansion of the steam.

Steam turbines are made in a variety of sizes ranging from small 0.75 kW units used as mechanical drives for pumps, compressors and other shaft driven equipment, to 1,500,000kW turbines used to generate electricity. Steam turbines are widely used for marine applications for vessel propulsion systems. In recent times gas turbines, as developed for aerospace applications, are being used more and more in the field of power generation once dominated by steam turbines.

The steam energy is converted mechanical work by expansion through the turbine. The expansion takes place through a series of fixed blades (nozzles) and moving blades each row of fixed blades and moving blades is called a stage. The moving blades rotate on the central turbine rotor and the fixed blades are concentrically arranged within the circular turbine casing which is substantially designed to withstand the steam pressure.

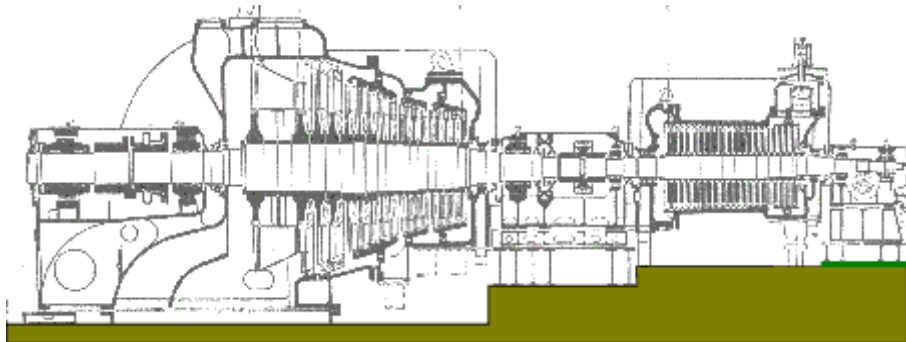

Image 4. 4 A steam turbine (Clipart.org)

4.4 GAS TURBINES

A gas turbine, also called a combustion turbine, is a rotary engine that extracts energy from a flow of combustion gas. It has an upstream compressor coupled to a downstream turbine, and a combustion chamber in-between. (Gas turbine may also refer to just the turbine element.)

Energy is added to the gas stream in the combustor, where air is mixed with fuel and ignited. Combustion increases the temperature, velocity and volume of the gas flow. This is directed through a nozzle over the turbine's blades, spinning the turbine and powering the compressor.

Energy is extracted in the form of shaft power, compressed air and thrust, in any combination, and used to power aircraft, trains, ships, generators, and even tanks.

Gas turbines are described thermodynamically by the Brayton cycle, in which air is compressed isentropically, combustion occurs at constant pressure, and expansion over the turbine occurs isentropically back to the starting pressure.

In practice, friction and turbulence cause:

- Non-isentropic compression: for a given overall pressure ratio, the compressor delivery temperature is higher than ideal.
- Non-isentropic expansion: although the turbine temperature drop necessary to drive the compressor is unaffected, the associated pressure ratio is greater, which decreases the expansion available to provide useful work.
- Pressure losses in the air intake, combustor and exhaust: reduces the expansion available to provide useful work.

As with all cyclic heat engines, higher combustion temperature means greater efficiency. The limiting factor is the ability of the steel, nickel, ceramic, or other materials that make up the engine to withstand heat and pressure. Considerable engineering goes into keeping the turbine parts cool. Most turbines also try to recover exhaust heat, which otherwise is wasted energy. Recuperators are heat exchangers that pass exhaust heat to the compressed air, prior to combustion. Combined cycle designs pass waste heat to steam turbine systems. And combined heat and power (co-generation) use waste heat for hot water production.

Mechanically, gas turbines can be considerably less complex than internal combustion piston engines. Simple turbines might have one moving part: the shaft/compressor/turbine/alternative-rotor assembly (see image above), not counting the fuel system. However, the required precision manufacturing for components and temperature resistant alloys necessary for high efficiency often makes the construction of a simple turbine more complicated than piston engines.

More sophisticated turbines (such as those found in modern jet engines) may have multiple shafts (spools), hundreds of turbine blades, movable stator blades, and a vast system of complex piping, combustors and heat exchangers.

As a general rule, the smaller the engine the higher the rotation rate of the shaft(s) needs to be to maintain top speed. Turbine blade top speed determines the maximum pressure that can be gained; this produces the maximum power possible independent of the size of the engine. Jet engines operate around 10,000 rpm and micro turbines around 100,000 rpm.

Thrust bearings and journal bearings are a critical part of design. Traditionally, they have been hydrodynamic oil bearings, or oil-cooled ball bearings. These bearings are being surpassed by foil bearings, which have been successfully used in micro turbines and auxiliary power units.

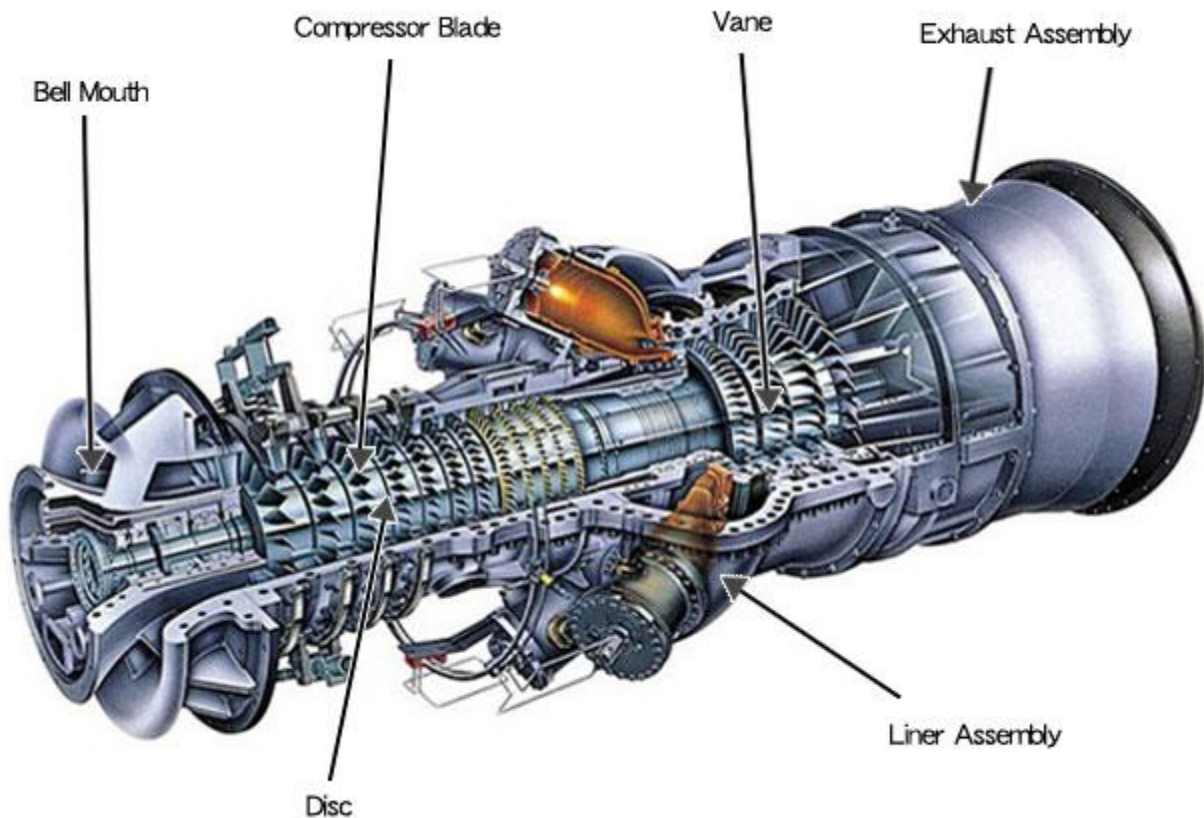

Image 4. 5 A gas turbine (Emcon Systems Technical Machinery Consulting)

4. 5 NUCLEAR-POWERED STEAM TURBINES

A nuclear-powered ship is constructed with the nuclear power plant inside a section of the ship called the reactor compartment. The components of the nuclear power plant include a high-strength steel reactor vessel, heat exchanger(s) (steam generator), and associated piping, pumps, and valves. Each reactor plant contains over 100 tons of lead shielding, part of which is made radioactive by contact with radioactive material or by neutron activation of impurities in the lead.

The propulsion plant of a nuclear-powered ship or submarine uses a nuclear reactor to generate heat. The heat comes from the fusing of nuclear fuel contained within the reactor. Since the

fusioning process also produces radiation, shields are placed around the reactor so that the crew is protected.

The nuclear propulsion plant uses a pressurized water reactor design which has two basic systems - a primary system and a secondary system. The primary system circulates ordinary water and consists of the reactor, piping loops, pumps and steam generators. The heat produced in the reactor is transferred to the water under high pressure so it does not boil. This water is pumped through the steam generators and back into the reactor for re-heating.

In the steam generators, the heat from the water in the primary system is transferred to the secondary system to create steam. The secondary system is isolated from the primary system so that the water in the two systems does not intermix.

In the secondary system, the steam flows from the steam generators to drive the turbine generators, which supply the ship with electricity, and to the main propulsion turbines, which drive the propeller. After passing through the turbines, the steam is condensed into water which is fed back to the steam generators by the feed pumps. Thus, both the primary and secondary systems are closed systems where water is recirculated and renewed.

Naval reactors undergo repeated power changes for ship manoeuvring, unlike civilian counterparts which operate at steady state. Nuclear safety, radiation, shock, quieting, and operating performance requirements in addition to operation in close proximity to the crew dictate exceptionally high standards for component manufacturing and quality assurance. The internals of a Naval reactor remain inaccessible for inspection or replacement throughout a long core life -- unlike a typical commercial nuclear reactor, which is opened for refuelling roughly every eighteen months.

Since there is no step in the generation of this power which requires the presence of air or oxygen, this allows the ship to operate completely independent from the earth's atmosphere for extended periods of time.⁵

⁵ Diesel engine design by H. F. P. PURDAY published by Constable, 1948 5th edition (pages 201-210, 226-233, 267-277, 280-285)

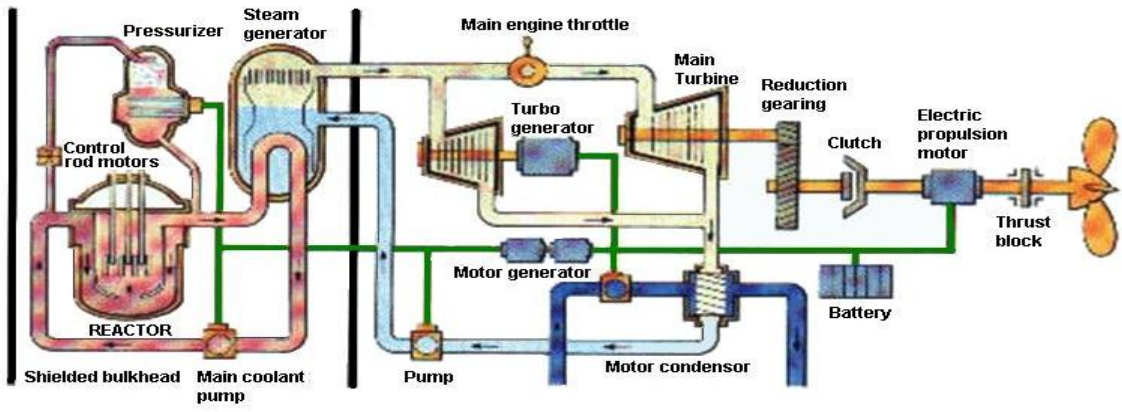

Image 4. 6 A nuclear powered steam turbine system (Federation of American Scientists)

CHAPTER 5

THE PROPELLERS

A propeller is a type of fan that transmits power by converting rotational motion into thrust. A pressure difference is produced between the forward and rear surfaces of the airfoil-shaped blade, and a fluid (such as air or water) is accelerated behind the blade. A propeller is known as screw both in aviation and maritime.

A propeller is the most common propulsion on ships, imparting momentum to a fluid which causes a force to act on the ship.

The ideal efficiency of any size propeller (free-tip) is that of an actuator disc in an ideal fluid. An actual marine propeller is made up of sections of helicoidally surfaces which act together 'screwing' through the water (hence the common reference to marine propellers as "screws"). Three, four, or five blades are most common in marine propellers, although designs which are intended to operate at reduced noise will have more blades. The blades are attached to a boss (hub), which should be as small as the needs of strength allow - with fixed pitch propellers the blades and boss are usually a single casting.

An alternative design is the controllable pitch propeller (CPP, or CRP for controllable-reversible pitch), where the blades are rotated normal to the drive shaft by additional machinery - usually hydraulics - at the hub and control linkages running down the shaft. This allows the drive machinery to operate at a constant speed while the propeller loading is changed to match operating conditions. It also eliminates the need for a reversing gear and allows for more rapid change to thrust, as the revolutions are constant. This type of propeller is most common on ships such as tugs where there can be enormous differences in propeller loading when towing compared to running free, a change which could cause conventional propellers to lock up as insufficient torque is generated.

The downsides of a CPP/CRP include: the large hub which decreases the torque required to cause cavitations, the mechanical complexity which limits transmission power and the extra blade shaping requirements forced upon the propeller designer.



Image 5. 1 A typical heavy vessel's propeller (**Mitsubishi Heavy Industries, Ltd**)

5. 1 TYPES OF PROPELLER

Propellers are be classified on the basis of several factors. The classification of different types of propellers is shown below:

A) Classification by Number of Blades Attached:

Propeller blades may vary from 3 blade propellers to 4 blade propellers and sometimes even 5 blade propellers. However, the most commonly used are 3 blades and 4 blade propellers.

a. 3 BLADE PROPELLER



Image 5. 2 A three blades propeller (**Deviantart.com**)

A 3 blade propeller has following characteristics:

- The manufacturing cost is lower than other types.
- Are normally made up of aluminium alloy.
- Gives a good high speed performance.
- The acceleration is better than other types.
- Low speed handling is not much efficient.

b. 4 BLADE PROPELLER



Image 5. 3 A four blade propeller (Shutterstock.com)

A 4 blade propeller has following characteristics:

- The manufacturing cost is higher than 3 blade propellers.
- 4 blade propellers are normally made up of stainless steel alloys.
- Have better strength and durability.
- Gives a good low speed handling and performance.
- Has a better holding power in rough seas.

- A 4 blade propeller provides a better fuel economy than all the other types.

c. 5 BLADE PROPELLER



Image 5. 4 A five blade propeller (**NauticExpo**)

A 5 blade propeller has following characteristics:

- Manufacturing cost is higher of all.
- Vibration is minimal from all the other types.
- 5 blade propellers have better holding power in rough seas.

B) Classification By pitches of the blade:

Pitch of a propeller can be defined as the displacement that a propeller makes for every full revolution of 360° . The classification of the propellers on the basis of pitch is as follows.

a. Fixed Pitch Propeller:

The blades in fixed pitch propeller are permanently attached to the hub. The fixed pitch type propellers are casted and the position of the blades and hence the position of the pitch is permanently fixed and cannot be changed during the operation.

Fixed pitch propellers are robust and reliable as the system doesn't incorporate any mechanical and hydraulic connection as in Controlled Pitch Propeller (CPP). The manufacturing, installation and operational costs are lower than controlled pitch propeller (CPP) type. The manoeuvrability of fixed pitch propeller is also not as good as CPP.

b. Controllable Pitch Propeller:

In Controlled Pitch type propeller, it is possible to alter the pitch by rotating the blade about its vertical axis by means of mechanical and hydraulic arrangement. This helps in driving the propulsion machinery at constant load with no reversing mechanism required as the pitch can be altered to match the required operating condition. Thus the manoeuvrability improves and the engine efficiency also increases.

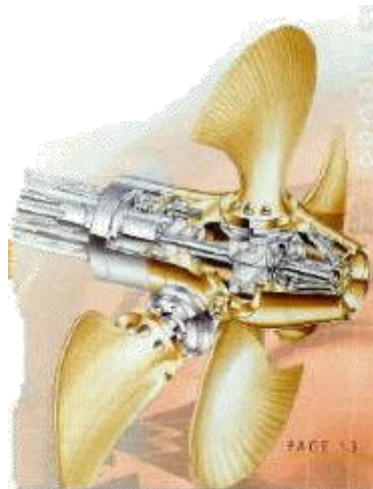

Image 5. 5 A controllable pitch propeller (**ALFGAM**)

This drawback includes the possibility of oil pollution as the hydraulic oil in the boss which is used for controlling the pitch may leak out. It is a complex and expensive system from both installation and operational point. Moreover, the pitch can get stuck in one position, making it difficult to manoeuvre the engine.

5.2 CAVITATION

However, using a propeller to give thrust power to a ship, leads to a big problem. The cavitation problem.

Cavitation is the formation and then immediate implosion of cavities in liquid – i.e. small liquid-free zones ("bubbles") – that are the consequence of forces acting upon the liquid. It usually occurs when a liquid is subjected to rapid changes of pressure that cause the formation of cavities where the pressure is relatively low.

Cavitation is a significant cause of wear in some engineering contexts. When entering high pressure areas, cavitation bubbles that implode on a metal surface cause cyclic stress. These results in surface fatigue of the metal causing a type of wear also called "cavitation". The most common examples of this kind of wear are pump impellers and bends when a sudden change in the direction of liquid occurs. Cavitation is usually divided into two classes of behaviour: inertial (or transient) cavitation and non-inertial cavitation.

Inertial cavitation is the process where a void or bubble in a liquid rapidly collapses, producing a shock wave. Inertial cavitation occurs in nature in the strikes of mantis shrimps and pistol shrimps, as well as in the vascular tissues of plants. In man-made objects, it can occur in control valves, pumps, propellers and impellers.

Non inertial cavitation is the process in which a bubble in a fluid is forced to oscillate in size or shape due to some form of energy input, such as an acoustic field. Such cavitation is often employed in ultrasonic cleaning baths and can also be observed in pumps, propellers, etc.

Since the shock waves formed by cavitation are strong enough to significantly damage moving parts, cavitation is usually an undesirable phenomenon. It is specifically avoided in the design of machines such as turbines or propellers, and eliminating cavitation is a major field in the study of fluid dynamics.⁶

-
- ⁶ Marine Propellers and Propulsion by JOHN CARTLON 2007, published by Elsevier Ltd. (pages 1-10, 11-13, 20-23, 205-207)

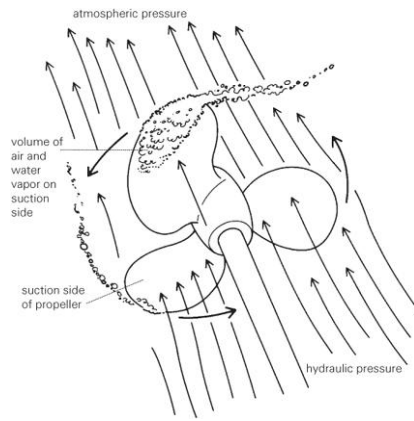

Image 5. 6 The cavitation phenomena ([Answers.com](https://www.answers.com))

CHAPTER 6

MAIN PRINCIPALS AND EQUIPMENT OF PROPULSION SYSTEM FACILITIES

The engine room in the merchant ships is placed in the aft part of the ship, so the available space can be maximized for the transportation of the ships loads and the ships propeller length minimization, so the engine room can be near to the accommodation.

The symmetric distribution of the ships weights and the symmetric placement of the ships tanks in the engine room are necessary, so they can not affect the ships stability. For that reason the heavy components are placed at the lower possible level.

The sea water pumps must placed under the water line of the vessel, so when she is without load, the problem of cavitations can be avoided. The similar machinery must be placed in a relative close distance between them, so their manipulation is easy and the length of their plumbing is small. The plumbing must not pass through tanks, for their inspection and their maintenance can be easy.

The air reservoirs of the starting air system are placed in relative slope, so their drain can take place easy.

6.1 Joints

When reduction gears are used between the engine and the propeller shaft, usually some kind of joint is used after the engine and before the reduction gear. This joint has those operations:

- Operates as dumper, so it can normalize the steep changes of the engines torques, and the reduction gear can be protected.
- It can be used as fast clutch of connection-disconnection during the manoeuvring procedure.
- Operates as safety system for the maximum torque that is being transferred.

The different categories of the joints that are used are: a) electromagnetic b) hydraulic c) air and d) mechanical. The last category can not be used as clutch instead of the others.



Image 6. 1 Mechanical Joint (Fire Controlman)

6.2 REDUCTION GEARS

The reduction gears are used for decreasing the rotation speed of the engines shaft into a speed that is appropriate for the maximum performance of the ships propeller. They use couples of «toothed» gears, with different number of tooth and different diameter for each gear. The reduction of the revolutions is accompanied by the increase of torque, so the transferred power can be stable.

The reduction gears that are used in middle-stroke engines have one step of reduction, and the gogging are simple or double helical. For the achievement of the reduction the gear with the small gogging and diameter is obviously placed at the side of the engine and the big gear at the side of the engines shaft. The ratio of revolutions reduction must not be higher than 4:1 but usually is between 2:1 or 2, 5:1.

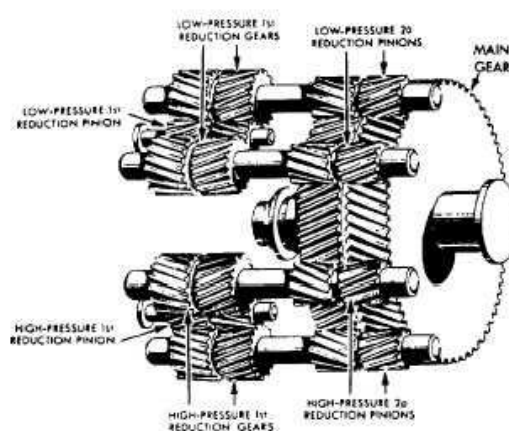

Image 6. 2double helical Reduction gears (Fire Controlman)

6.3 THRUST BLOCK

The thrust block transfers the movement from the propeller to the hull of the ship. It must therefore be solidly constructed and mounted onto a rigid seating or framework of perform its task. It may be an independent unit or an integral part of the main propulsion system. Both ahead and astern thrusts must be catered for and the construction must be strong enough to withstand normal and shock loads.

The casing of the independent thrust block is in two halves which is joint by fitted bolts. The thrust loading is carried by bearing pads which are arranged to pivot or tilt. The pads are mounted in holders or carriers and faced with white metal. In the arrangement shown the pads extend three-quarter of the distance around the collar and transmit all thrust to the lower of the casing. Other designs employ a complete ring of pads. An oil scraper deflects the oil lifted by the trust collar and directs it onto the pad stops. From here it cascades over the thrust pads and bearings. The shaft is manufactured with integral flanges for bolting to the engine or gearbox shaft and the intermediate shafting, and the thrust collar for absorbing the thrust.



Image 6. 3 Thrust block (Mitchell type) (**Wikipedia**)

6.4 SHAFT BEARING

Shaft bearing are of two types, the aftermost tunnel bearing and all others. The aftermost tunnel bearing has a top and a bottom bearing shell because it must counteract the propeller mass and take a vertical upward thrust at the forward end of the tail shaft. The other shaft bearings only support the shaft weight and thus have only lower bearing shell. The usual journal bush is here replaced by pivoting pads. The tilting pad is better able to carry high overload, and retain a thick oil lubricating film.

Lubrication is from a bath in the lower half of the casing and an oil thrower ring dips into the oil and carries it round the shaft as it rotates. Cooling of the bearing is by water circulating through a tube in the bottom of the casing.



Image 6. 4 Intermediate shaft bearing (Hi-Sea Marine)

6.5 STERN TUBE BEARING

The stern tube bearing serves two important purposes. It supports the tail shaft and a conservable proportion of the propeller weight. It also acts as a gland to prevent the entry of the sea water to the machinery place. Early arrangements used bearings made from timber which were lubricated by sea water. Most modern designs use an oil lubrication arrangement for a white metal lined stern tube bearing.

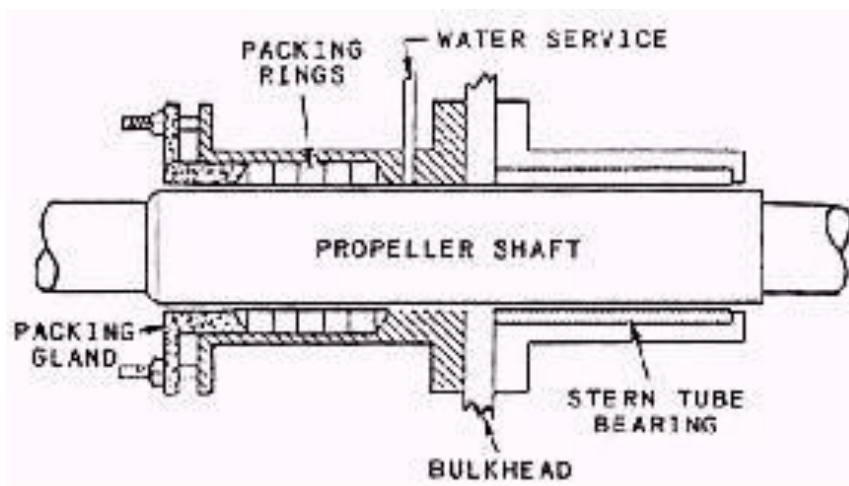

Image 6. 5 Stern tube system (Engine Mechanics)

6.6 STERN TUBE SEALS

Special seals are fitted at the outboard ends of the tail shaft. They are arranged to prevent the entry of the sea water and also the loss of the lubricating oil from the stern bearing.

Older designs, usually associated with sea water lubricated stern bearings, made use of a conventional stuffing box and gland at the after bulk head oil. Lubricated stern bearings use either lip or radial face seals or a combination of the two.

Lip seals are shaped rings of material with a projecting lip or edge which is held in contact with a shaft to prevent oil leakage or water entry. A number of lip seals are usually fitted depending upon the particular application face seals use a pair of mating radial faces to seal against leakage. One face is stationary and the other rotates. The rotating face of the after seal is usually secured to the propeller boss. The stationary face of the forward on in board seal is the after bulkhead as spring arrangement forces the stationary and rotating face together.⁷

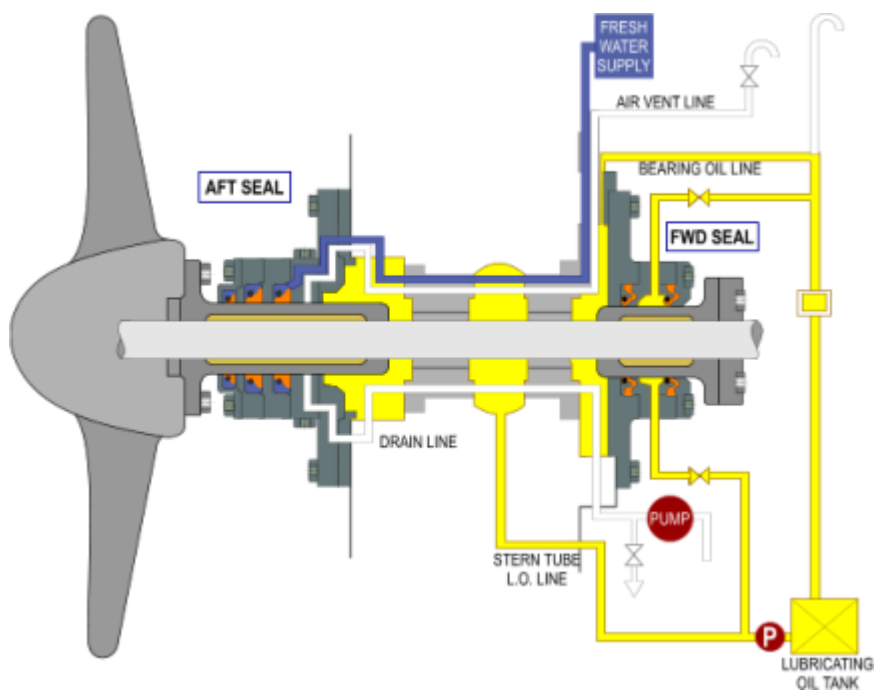

Image 6. 6 The way that stern tube is sealed (Marine Insight)

⁷ Marine English notes (semester E')

CHAPTER 7

DIESEL-ELECTRIC PROPULSION

Diesel-electric transmission or diesel-electric power is used by a number of vehicle and ship types for providing locomotion.

A diesel-electric transmission system includes a diesel engine connected to an electrical generator, creating electricity that powers electric traction. No clutch is required.

Before diesel engines came into widespread use, a similar system, using petrol (gasoline) engine and called petrol-electric or gas-electric, was sometimes used.

This kind of power transmission is used on railways by diesel electric locomotives and diesel electric multiple units as only electric motors are able to supply full torque at 0 RPM. Diesel-electric systems are also used in submarines and surface ships and some land vehicles.

In some high-efficiency applications, electrical energy may be stored in rechargeable batteries, in which case these vehicles can be considered as a class of hybrid electric vehicle.

The first diesel motor ship was also the first diesel-electric ship, the Russian tanker *Vandal* from Branobel, which was launched in 1903. Steam turbine-electric propulsion has been in use since the 1920s (Tennessee class battleships), using diesel-electric power plants in surface ships has increased lately. The Finnish coastal defence ship *Ilmarinen*, laid down in 1929, was among the first surface ships to use diesel-electric transmission. Later, the technology was used in diesel powered icebreakers.

Some modern ships, including cruise ships and icebreakers, use electric motors called azimuth thrusters to allow 360° rotation, making the ships far more manoeuvrable.

Gas turbines are also used for electrical power generation and some ships use a combination: the *Queen Mary 2* has a set of diesel engines in the bottom of the ship plus two gas turbines mounted near the main funnel; all are used for generating electrical power, including that used to

drive the propellers.⁸ Electric propulsion solutions with two or more shafts usually incorporate electric motors which drive a propeller.

If an electric motor and a propeller are closely combined in one unit, this is called POD which can be mounted externally to the main hull. The electric motors are supplied by electricity generators which may consist entirely of gas turbines alternators, or be or a combination of diesel alternators and gas turbines alternators. The diagram below shows an example of a "full electric" example of architecture. The "prime movers" are two Rolls Royce WR-21 gas turbine alternator sets rated at 21MW, and four diesels alternators of 5-7MW, divided in to two units each powering a 28MW electric motor which drives a propeller shaft.

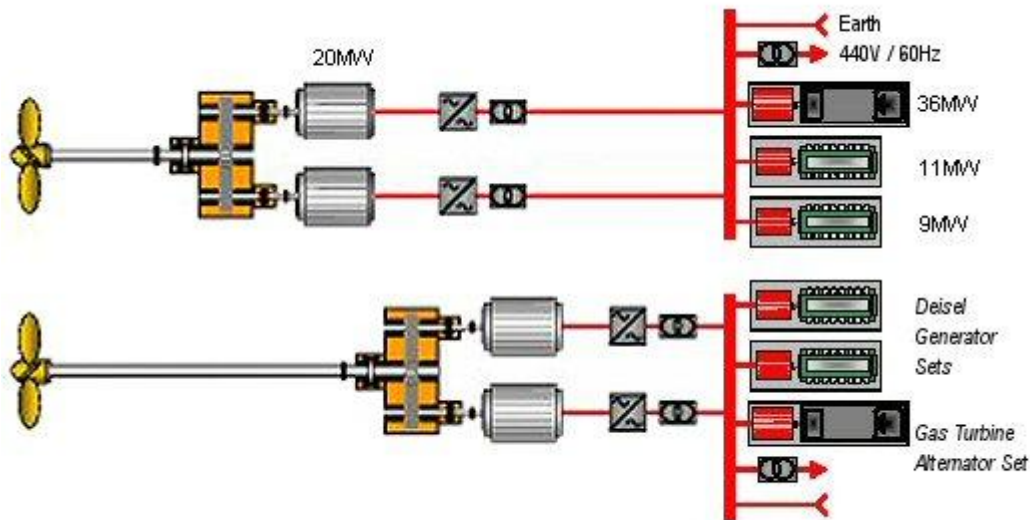

Image 7. 1 A diesel electric propulsion system (Navy Matters)

-
- ⁸ Internal combustion engines volume 2 2008, published by Institute Eugenidou (pages 105-108)

CHAPTER 8

NON-CONVENTIONAL PROPULSION SYSTEMS

8.1 STEERABLE AZIMUTH DRIVE SYSTEM

An azimuth thruster is a configuration of ship propellers placed in pods that can be rotated in any horizontal direction, making a rudder unnecessary. These give ships better maneuverability than a fixed propeller and rudder system

There are two major variants, based on the location of the motor:

-Mechanical transmission, where a motor inside the ship is connected to the pod by gearing. The motor may be diesel or diesel-electric. Depending on the shaft arrangement the mechanical azimuth thrusters are divided into L-drive and Z-drive. An L-drive thruster has a vertical input shaft and horizontal output shaft with one right-angle gear. A Z-drive thruster has a horizontal input shaft, vertical shaft in the rotating column and a horizontal output shaft with two right-angle gears.

-Electrical transmission, where an electric motor is in the pod itself, connected directly to the propeller without gears. The electricity is produced by an onboard engine, usually diesel or gas turbine. Invented in 1955 and it was the first product using this technology.

Mechanical azimuth thrusters can be fixed installed, retractable and underwater-mountable. They may have fixed pitch propellers (FPP) or controllable pitch propellers (CPP). Fixed installed thrusters are used for tugs, ferries and supply-boats. Retractable thrusters are used as auxiliary propulsion for dynamically positioned (DP) vessels and take-home propulsion for military vessels. Underwater-mountable thrusters are used as dynamic positioning propulsion for very large vessels such as semi-submersible drilling rigs.

Primary advantages are electrical efficiency, better use of ship space, and lower maintenance costs. Ships with azimuth thrusters do not need tugs to dock, though they still require tugs to maneuver in difficult places.



Image 8. 1 Steerable azimuth system propellers (**Nautilia**)

8.2 WATER JET PROPULSION

The water jet propulsion is based on the principal of action-reaction. Axial flow hydrodynamic pump sucks water from the hull part and it launches it, through adjustable nozzle, with high speed backwards. Due to the change of water's momentum the vessel moves forward. With the assistance of fins the water jet can move right and left and moves also the vessel right or left. And with the descent of a special deflector the vessel moves backwards. The easy movement and the deflection of the water jet allow the easy manoeuvring procedure and at the same time create high speeds.⁹



Image 8. 2 A water jet motor (**TradeKorea.com**)

-
- ⁹ Internal combustion engines volume 2 2008, published by Institute Eugenidou (pages 119-120)

CHAPTER 9

EXPERIMENTAL PROPULSION SYSTEMS

9.1 WIND PROPULSION

Wind propulsion emerged as an alternative to those systems which emit huge quantities of CO₂ gases in the marine atmosphere. However, the usage of wind turbine marine propulsion has not started extensively in large commercial ships because of a requirement of constant windiness. Two wind propulsion systems for ships that have become lately are- kite propulsion and sail propulsion for merchant ships.

The Skysails propulsion system consists of a large foil kite, an electronic control system for the kite and an automatic system to retract the kite. The system bears similarities to kite surfing. The system was first tested on the Baltic Sea, before commercial implementation. The kites, which have an area of around 320 square meters (3,400 sq ft), can be flown at altitudes of 100–300 meters (330–980 ft). Because of the stronger winds at these heights, they receive a substantially higher thrust per unit area than conventional mast-mounted sails. A ship equipped with the current Skysails could consume from 10 to 35% less fuel.^[1] A conventional ship with a Skysail-system has two propulsion methods, making it a type of hybrid vehicle. Skysail kite propulsion from upper wind power is a traction use of high altitude wind power.



Image 9. 1 Propulsion with wind kite

9.2 FUEL CELL PROPULSION

A fuel cell is a device that converts the chemical energy from a fuel into electricity through a chemical reaction with oxygen or another oxidizing agent. Hydrogen is the most common fuel, but hydrocarbons such as natural gas and alcohols like methanol are sometimes used. Fuel cells are different from batteries in that they require a constant source of fuel and oxygen to run, but they can produce electricity continually for as long as these inputs are supplied.

Welsh Physicist William Grove developed the first crude fuel cells in 1839. The first commercial use of fuel cells was in NASA space programs to generate power for probes, satellites and space capsules. Since then, fuel cells have been used in many other applications. Fuel cells are used for primary and backup power for commercial, industrial and residential buildings and in remote or inaccessible areas. They are used to power fuel cell vehicles, including automobiles, buses, forklifts, airplanes, boats, motorcycles and submarines.

There are many types of fuel cells, but they all consist of an anode (negative side), a cathode (positive side) and an electrolyte that allows charges to move between the two sides of the fuel cell. Electrons are drawn from the anode to the cathode through an external circuit, producing direct current electricity. As the main difference among fuel cell types is the electrolyte, fuel cells are classified by the type of electrolyte they use. Fuel cells come in a variety of sizes. Individual fuel cells produce very small amounts of electricity, about 0.7 volts, so cells are "stacked", or placed in series or parallel circuits, to increase the voltage and current output to meet an application's power generation requirements.



Image 9.2- fuel cell production

In addition to electricity, fuel cells produce water, heat and, depending on the fuel source, very small amounts of nitrogen dioxide and other emissions. The energy efficiency of a fuel cell is generally between 40-60%, or up to 85% efficient if waste heat is captured for use

9.3 SOLAR PROPULSION

Solar propulsion for ships was utilised for the first time in the year 2008. Solar propulsion benefits include a high reduction in the poisonous carbon dioxide emissions. Solar propulsions are capable of generating a capacitance as high as 40 kilowatts (kW).

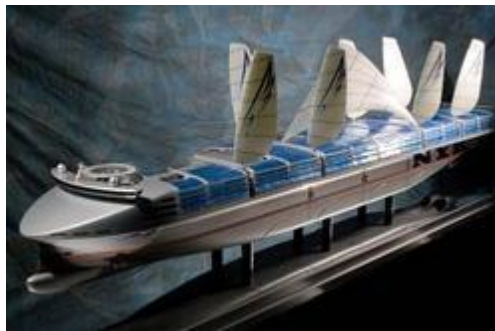

Image 9.3- a model of a ship with solar propulsion system

9.4 GAS FUEL OR TRI FUEL PROPULSION

LNG fuel is now utilised to be burnt in the Main Engine after adopting some modification in the propulsion engine to reduce emission from the ship. It is known as tri fuel because it can burn gas fuel, diesel and heavy fuel.

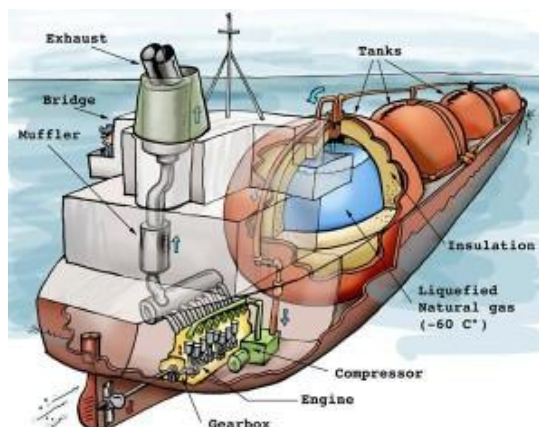

Image 9.3- a LNG ship that consumes its cargo gases as fuel for her engine

The various types of propulsion systems offer their own unique advantages to a vessel. Depending on the necessity and the requirement, the best type of ship propulsion system needs to be fitted. Only then the vessel will be able to offer its optimum service capacitance.

9.5 MAGNETOHYDRONAMIC PROPULSION

A magnetohydrodynamic drive or MHD propulsion is a method for propelling seagoing vessels using only electric and magnetic fields with no moving parts,

The working principle involves electrification of the propellant (gas or water) which can then be directed by a magnetic field, pushing the vehicle in the opposite direction. Although some working prototypes exist, MHD drivers remain impractical.

An electric current is passed through seawater in the presence of an intense magnetic field, which interacts with the magnetic field of the current through the water. Functionally, the seawater is then the moving, conductive part of an electric motor. Pushing the water out the back accelerates the vehicle in the forward direction.

The physics equation describing this propelling force is $\mathbf{F}_{\text{mag}} = I (\mathbf{L} \times \mathbf{B})$ where \mathbf{L} is the vector in the direction of the current 'I' and its length is the distance the current travels, \mathbf{B} is the magnetic field, and \times denotes the cross product.



Image 9.4- a magnetohydrodynamic vessel model

MHD is attractive because it has no moving parts, which means that a good design might be silent, reliable, efficient, and inexpensive.

The major problem with MHD is that with current technologies it is more expensive and much slower than a propeller driven by an engine. The extra expense is from the large generator that must be driven by an engine. Such a large generator is not required when an engine directly.¹⁰

-
- ¹⁰ <http://www.marineinsight.com/tech/main-engine/different-types-of-marine-propulsion-systems-used-in-the-shipping-world/>

CHAPTER 10

PROPULSION SYSTEMS LAYOUT

10.1 DEEP SEA VESSEL

Probably the most common propulsion set up out there. Look into any harbours, you will most likely see ten ships (over 10,000 grt), and perhaps nine, if not all of them, will have this set up. Bulk carriers, container ships, OBO, large fishing vessels, tankers and some cruise ships are some vessels that use this setup.

The engine is generally a slow speed two stroke engine, such as a B&W or Sulzer. It is directly connected to the propeller shaft. Forward thrust of the fixed pitch propeller is channelled to the frames of the ship by the thrust block. Reverse is obtained by running the engine in reverse; they are designed with a variable cam which allows this to happen. This set up is simple, efficient and "easy" to operate and maintain.

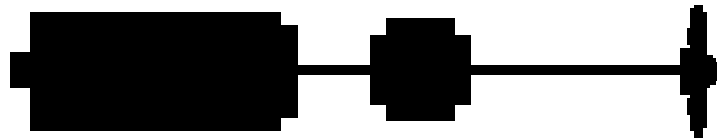

Image 10.1- deep vessels propulsion system

10.2 SPECIALIZED VESSELS

This setup is very common on medium size specialized vessels, such as Stand By Vessels (AHST) Research, cable ships and such. The CCGS Gordon Reid is a search and rescue vessel, it features two of this of type of set up. The four engines and two shafts with CPPs offer a high degree of redundancy and versatility. In the case of the Reid, the outside engines also drive fire pumps feeding water to big fire monitors above the wheel house; as you would find on a oil rig "stand by" vessel.

Two four stroke, medium speed engines are used here for their low size to power ratio. Having two engines also offers a level of redundancy. They can be operated simultaneously or individually

because of the clutch. The gear box will compensate for the high speed of the engines and allow the propeller to turn a more efficient slower speed. In the power range of typical four stroke Diesels, the thrust bearing is usually fitted within the gear box, but occasionally it is an independent fixture. The CPP system provides the quick response these types of vessels require.



Image 10.2- specialized vessels propulsion system

10.3 COASTAL VESSELS

This set up is common on larger fishing boats, coastal freighter; some medium size tugs (~4000 hp). It is without mystery; the parts are easily serviceable because there usually "off the shelf".

One four stroke medium speed Diesel engines which is geared and be run without turning the shafting because of the clutch. The CPP offers a responsive level of control and reverse! The set up is straight forward and easy to maintain.

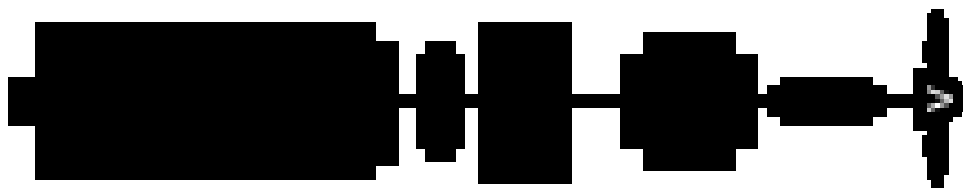

Image 10.3- coastal vessels propulsion system

10.4 SMALL BOATS

This is typical set up of small vessels. Yacht, tugs, fishing boats, small ferries etc. It is very common to see this in vessels having less than 2000 hp. It is very simple and the whole package is pretty much "off the shelf".

The Diesel engine can be a two stroke (i.e. Detroit Diesel) or a four stroke (i.e. Cummins, Caterpillar). It is almost always a high speed engine which requires the marine gear (i.e. Twin Disc). The gear has a built in clutch, actually two clutches, one for forward and one to obtain reverse. The gearbox also has the thrust bearing built in. The fix pitch propeller is attached to the end of the shaft. This set up is very manageable and reliable.



Image 10.4- small boats propulsion system

10.5 CRUISE SHIPS

The height of practical modern ship engineering is the Diesel electric cruise ship. Most of the cruise ships are relatively new and most of them feature propulsion set up much like this one. It offers more room for paying passengers; it is versatile and has a high degree of reliability. It is an efficient system, as you can adapt supply power to your demand. It is technologically complex but relatively easy to operate.

The engines are usually four stroke medium speed engines, this is because of their bigger size to power ratio, so you don't need a big engine room space. In the past, you would have two big engines to drive the vessel and three others to supply the large electrical hotel load.

This would underutilize the horse power in the vessel. In newer ships, all the engines are generators and they supply one common electrical bus. Engineers can then adapt power supply to the demand, making the whole process a little bit more efficient, much like a power utility on land.

The propulsion is done via electrical motors which are built into pods controlled by cycle-converters (not shown). The pods hang below the ship hull increasing their efficiency. Essentially the propulsion becomes just another "load" on the "power grid". It is a big load that's why there is so many engines, sometimes of varying size. The QE2 has nine identical MAN medium speed Diesels generators. Having so many engines makes it easier to perform maintenance on the fly, reducing down time and increasing profitability. Another feature is the ability to physically isolate the various engines therefore reduces the chances of a catastrophic failure of the system in case of a fire or such. The engine room is several compartments as oppose to the one large compartment that it use to be. It is my opinion that will we see this type of propulsion system become more prevalent on many different types of ships as the price of technology decreases and the system simplifies.

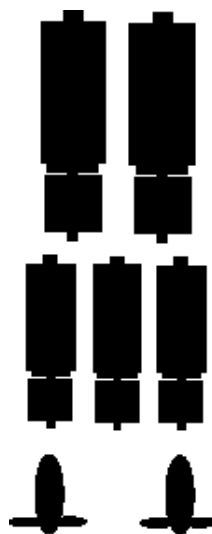

Image 10.5- cruise ships propulsion system

10.6 ICEBREAKERS

The cruise ship did not really innovate the idea of Diesel electric propulsion. It has been around since the beginning of Diesel application in ships. Back then there was no way to get reverse save for a Diesel electric set up. Submarines were another big consumers of Diesel electric set ups. But the most accessible consumer was the icebreakers of the world. They require large

horse power but often encounter shock loading from hitting big pieces of ice and such. Diesel engines do not appreciate shock loading.

The Diesel electric propulsion allowed the shocks to be "filtered" by the electrical machinery and pass on to the engines in more manageable increments. The system illustrated here is from the CCGS Sir Wilfrid Laurier, a Canadian medium icebreaker. It features three 2200 kW medium speed V16 Alco 251. The AC generator feeds a common bus at 6600 VAC. The propulsion systems consist of two electrical motors driving two fixed pitch propellers. Fixed pitch propellers and their simplicity are less likely to fail in ice conditions as oppose to the more delicate CPP ones. The motors are controlled by two cycle-converters. Cycle-converters are a web page unto themselves, but basically, they allow the electric motors to turn, forward or reverse, at any given power (speed) required.

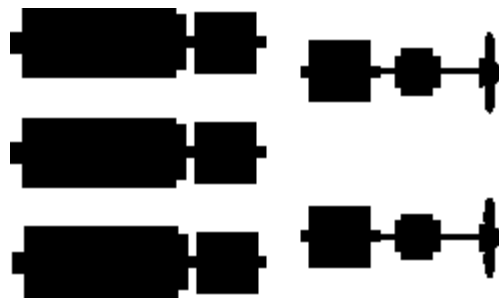

Image 10.6a- ice-breaker propulsion system

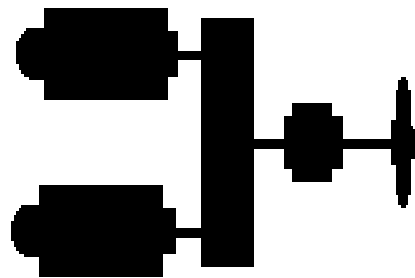

Image 10.6b- ice-breaker propulsion system

10.7 NAVAL VESSELS AND TANKERS

Naval vessels and other military ships have other priorities than fuel efficiency. Therefore we often see high powered propulsion set up in these vessels. That amount of power comes from

fuel thirsty gas turbines or steam turbines. The US navy is an avid consumer of steam plants - a great number of their vessel obtains steam from nuclear means.

Traditional steam plants are still in operation but over the years the marine gas turbine has become more prevalent for its power to weight ratio (no need for a big boiler and its systems). In Canada, our Halifax class frigates are power with gas turbines, but of course, we are not a rich nation, so the propulsion plant also includes a more economical medium speed Diesel plant. In the merchant marine, steam propulsion plants are relatively rare, as the Diesel engine can do the same work more efficiently. Large tankers still use steam plants, this is due to the huge power requirements that the Diesel engine has not been able to practically deliver.

Turbine plants are usually compact, "lightweight" high powered, and turn at a high rate of speed. Their operation is simple but their maintenance and fuel consumption make sure it is not the most popular choice for ship's propulsion. Above right, we see the military type set up. One gas turbine and two cruising Diesels - medium speed four strokes. Each is capable of inputting power and that power is controlled by a CPP. To the right we have a tanker steam turbine set up. As there is no CPP, the steam turbine will have a reversing turbine built into each. The power feeds into the gear box reducing the rpm, then into a fix pitch propeller.

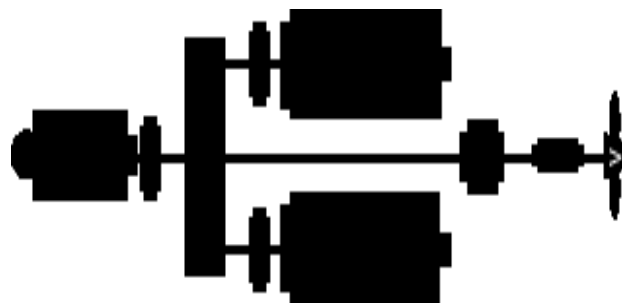

Image 10.7- naval and tankers vessels propulsion system

10.8 DOUBLE ENDED FERRIES

The "double ender" ferry is another unique animal. It is quite common to see this type of vessel in the North American northwest. BC and Washington state ferries use the double ender ferries extensively. They carry large quantities of vehicles and passengers on short runs in calm

waters. To save the time of turning the vessel around at each berth, they just simply make sure it goes easily one way as it does the other way.

This gives rise to an interesting design; one propeller and rudder at each end of the vessel. The actual propulsion equipment is not that complicated. Take for example the BC Ferries Queen of Cowichan. It has two MAK 550 medium speed four stroke Diesel engines each producing about 6000 hp. They are couple to a gear box by two air operated clutches. The shafts are quite long, as they must go to both ends of the ship down the centreline. CPP and the two rudders make this vessel responsive. The ship has a service speed of 21 knots.¹¹

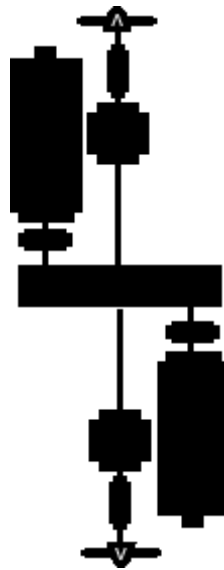

Image 10.8- double ended ferries propulsion system

11

[http://www.dieselduck.net/machine/02%20propulsion/propulsion layout/propulsion layout.htm](http://www.dieselduck.net/machine/02%20propulsion/propulsion%20layout/propulsion%20layout.htm)

AUTHOR'S OPINION

Traditionally, big two-stroke slow-speed diesel engines are dominating in tankers seagoing ships, in bulk carriers and in the container seagoing ships. Respectively middle-speed diesel engines are dominating in smaller merchant ships, such as ro-ro ships, cruise ships, passenger ships and in ships of special use like reefer ships and ice-breakers. In early years there was a distinction between the uses of those two engines. But now this is not happening anymore. Today we can find two-stroke diesel engines in small passenger ships and there are new powerful four-stroke diesel engines that can be found in ships that were using only two-stroke engines in the past. Therefore it's obvious that the choice for the type of a ship's engine should be based on techno-economic criteria and not the status of the past.

The reasons that led to the domination of two-stroke engines were their ability to consume low quality fuel, without the need of regular maintenance.

Many ship owners prefer specific types of engines, because they depend on their reliability, the familiarity of the crew with the specific types of engines, the available network of spare parts and the special relationship with the supplier company. So there are limits in their choices because there are still some standards that can prevail and make this decision more difficult.

The personnel is also an important factor for the choice of the engines that are big because they have high number of parts and it is more possible to break down, and is more difficult to get maintained. Furthermore the problems are increasing so the cost of the spare parts also. Meanwhile the knowledge of the crew in engine room is reduced so the construction of simpler engines is necessary.

As years pass technology achieves new developments. So through time we have proceeded from sails to the most powerful engines MC and ME and from paddles to completely automatic controllable pitch propellers. Although the field of propulsion is getting expanded, so it can reach the best possible efficiency and lead the merchant and the battle navy in new solution for their movement across the seas with new and completely advanced engines and machineries.

There are many marine diesel engines manufacturers. In the following charts, the most popular of them will be displayed and their domination in merchant marine ships.

TWO-STROKE ENGINES

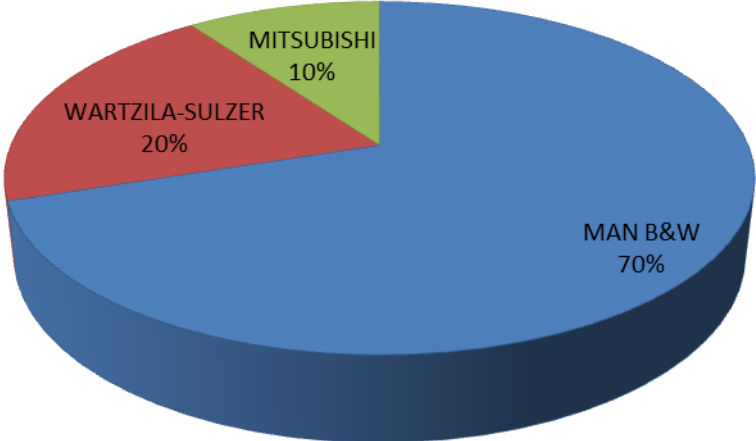

The most popular two-stroke engine manufacturing companies that ships are using, for their propulsion

FOUR-STROKE ENGINES

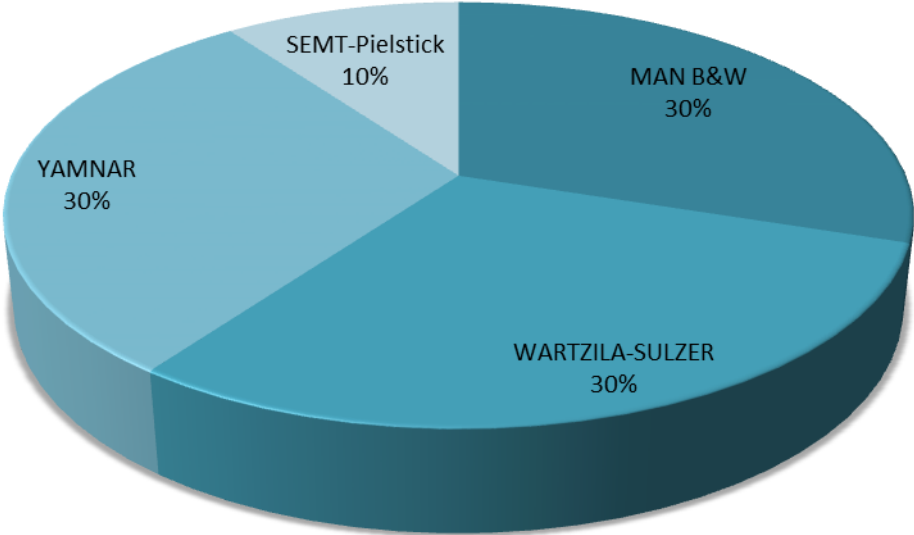

The most popular four-stroke engines manufacturing companies that ships are using for, their propulsion or for their electric production

As we can see from the charts MAN B&W is dominating between all companies that manufacture two-stroke engines. That is because through the years it has been proven the most reliable and the most resourceful when at the same time SULZER (once, now WARTZILA-SULZER after their merge) lost its prestige, to MAN B&W because it stopped producing its own series of engines with exhaust ports and bought the rights for using the exhaust valve system from MAN.

Also MITSUBISHI is still dominant, with only few of shipping companies choosing them for their ships. MITSUBISHI is constructing its models exclusive in Japanese factories and uses its own turbochargers models.

As for four-stroke engines, we can see that three companies are in the same league, with YANMAR proving herself as a very reliable company, due to the simple construction of her models and the high efficiency of them. MAN and WARTZILA are in the same level when it comes to four-stroke engines, with both of them adding continuously new innovations to their models. Last SEMT-Pielstic once powerful in the area of four-stroke engines now is disappearing as it designs only on specific models.

Bibliography:

- Basic ship propulsion by J.P GHOSE and R.P GORKAN 2004, published by Allied Publishers Pvt.Limited (pages 1-3)
- Diesel engine design by H. F. P. PURDAY published by Constable, 1948 5th edition (pages 201-210, 226-233, 267-277, 280-285)
- Marine Propellers and Propulsion by JOHN CARTLON 2007, published by Elsevier Ltd. (pages 1-10, 11-13, 20-23, 205-207)
- Internal combustion engines volume 2 2008, published by Institute Eugenidou (pages 99-103, 105-108, 119-120)
- Marine English notes (semester E')

Sources:

internet

- <http://www.marineinsight.com/tech/main-engine/different-types-of-marine-propulsion-systems-used-in-the-shipping-world/>
- http://www.dieselduck.net/machine/02%20propulsion/propulsion_layout/propulsion_layout.htm

INDEX

ABSTRACT1
INTRODUCTION2
CHAPTER 1: PROPULSION SYSTEMS IN GENERAL3
CHAPTER 2: THE MAIN PARTS OF THE PROPULSION SYSTEMS5
CHAPTER 3: HOW DOES A PROPULSION SYSTEM WORK6
CHAPTER 4: THE MAIN POWER IN PROPULSION SYSTEMS8
4.1 Reciprocation steam engines8
4.2 Reciprocation diesel engines9
4.3 Steam turbines12
4.4 Gas turbines13
4.5 Nuclear-powered steam turbines15
CHAPTER 5: THE PROPELLERS18
5.1 The types of propellers19
5.2 Cavitation23
CHAPTER 6: MAIN PRINCIPALS AND EQUIPMENT OF PROPULSION SYSTEM FACILITIES25
6.1 Joints25
6.2 Reduction gears26
6.3 Thrust block27
6.4 Shaft bearing27
6.5 Stern tube bearing28
6.6 Stern tube seals29

CHAPTER 7: DIESEL-ELECTRIC PROPULSION30
CHAPTER 8: NON CONVENTIONAL PROPULSION SYSTEMS32
8.1 Steerable azimuth drive system33
8.2 Water jet propulsion33
CHAPTER 9: EXPERIMENTAL PROPULSION SYSTEMS34
9.1 Wind propulsion34
9.2 Fuel cells propulsion35
9.3 Solar propulsion36
9.4 Gas fuel or tri fuel propulsión36
9.5 Magnetohydrnamic propulsion37
CHAPTER 10: PROPULSION SYSTEMS LAYOUT39
10.1 Deep sea vessels39
10.2 Specialized vessels39
10.3 Coastal vessels40
10.4 Small boat41
10.5 Cruise ships41
10.6 Icebreakers42
10.7 Naval vessels and tankers43
10.8 Double ended ferries44
AUTHORS OPNINION46
BIBLIOGRAPHY AND SOURCES49