

SUB-COMMITTEE ON HUMAN ELEMENT,  
TRAINING AND WATCHKEEPING  
2nd session  
Agenda item 3

HTW 2/3/2  
31 October 2014  
Original: ENGLISH

## VALIDATION OF MODEL TRAINING COURSES

### Model Course – Advanced Training for Oil Tanker Cargo Operations

#### Note by the Secretariat

#### SUMMARY

*Executive summary:* This document provides the draft of a revised model course on Advanced Training for Oil Tanker Cargo Operations

*Strategic direction:* 5.2

*High-level action:* 5.2.2

*Planned output:* 5.2.2.5

*Action to be taken:* Paragraph 3

*Related documents:* STW 40/14 and HTW 1/3/3

1 Attached in the annex is a revised draft model course on Advanced Training for Oil Tanker Cargo Operations.

2 As instructed by the Sub-Committee at its first session, this model course was referred to the correspondence group for further revision, to reflect closely the requirements of the 2010 Manila Amendments.

#### Action requested of the Sub-Committee

3 The Sub-Committee is invited to consider the above information and take action, as appropriate.

\*\*\*



**ANNEX**

**DRAFT IMO MODEL COURSE ON ADVANCED TRAINING FOR  
OIL TANKER CARGO OPERATIONS**

**MODEL  
COURSE**

**1.02**

**ADVANCED TRAINING  
FOR OIL TANKER CARGO  
OPERATIONS**

### **ACKNOWLEDGEMENTS**

This course for Advanced Training for Oil Tanker Cargo operations is based on material developed by Anglo Eastern Maritime Training Centre, Mumbai for IMO.

IMO wishes to express its sincere appreciation to the Government of India for its provision of expert assistance, valuable cooperation in support of this work.

## Contents

	<b>Page</b>
<b>Introduction</b>	4
<b>Part A</b> <b>Course Framework</b>	8
<b>Part B</b> <b>Course Outline and Timetable</b>	23
<b>Part C</b> <b>Detailed Teaching Syllabus</b>	32
<b>Part D</b> <b>Instructor Manual</b>	83
•      Appendix 1 (Diagrams)	187
•      Appendix 2 (Exercises)	216
•      Appendix 3 (Case Studies)	223
<b>Part E</b> <b>Evaluation</b>	234

## Introduction

### ■ Purpose of the model courses

The purpose of the IMO model course is to assist maritime training institutes and their teaching staff in organizing and introducing new training courses or in enhancing, updating or supplementing existing training material where the quality and effectiveness of the training courses may thereby be improved. The purpose is also to enhance the capabilities of shipboard personnel who sail on specialized carriers such as an oil tanker. It is not the intention of the course to compartmentalize the trainee's way of thinking in terms of tanker operation. The idea is to make him/her aware of the specialization of operations specific to an oil tanker and, sensitize him/her towards the responsibilities that s/he will face on such a vessel.

It is not the intention of the model course programme to present instructors with a rigid "teaching package" which they are expected to "follow blindly". Nor is it the intention to substitute audio-visual or "programmed" material for the instructor's presence. As in all training endeavors, the knowledge, skills and dedication of the instructors are the key components in the transfer of knowledge and skills to those being trained through IMO model course material. For those following planned training schemes approved by the administration, it is intended that this training may form an integral part of the overall training plan and be complementary to other studies. The training may be undertaken in progressive stages; for such candidates, it is not appropriate to specify the duration of the learning, provided achievement of the specified learning outcomes is properly assessed and recorded.

Because educational systems and the cultural backgrounds of trainees in maritime subjects vary considerably from country to country, the model course material has been designed to identify the basic entry requirements and trainee target group for each course in universally applicable terms, and to specify clearly the technical content and levels of knowledge and skills necessary to meet the technical intent of IMO conventions and related recommendations.

By successfully completing this course the masters, officers and others on board oil tankers who are intending to have immediate responsibilities for the cargo handling in port and care in transit will fulfill one of the mandatory minimum requirements of Regulation V/1-1 paragraph 3 of STCW Convention and Code, as amended. The coverage of the model course is wide in scope and includes oil tanker safety, fire safety measures and systems, prevention and control of pollution, operational practice and obligations under applicable laws and regulations, thereby covering all training necessary to apply the provisions of Annex I of MARPOL as amended. In addition, the course covers the managerial aspects on board including a section on risk assessment and safety management, as well as contingency planning in line with the ISM Code.

In order to keep the training programme up to date in future, it is essential that users provide feedback. New information includes the ISM code requirements and hence will provide better training in safety at sea and protection of the marine environment. Information, comments and suggestions should be sent to the Head of the STCW and Human Element Section at IMO, London.

## ■ Use of the model course

The instructor should review the course plan and detailed syllabus, taking into account the information provided under the entry standards specified in the course framework. The actual level of knowledge and skills and the prior technical education of the trainees should be kept in mind during the review, and any areas within the detailed syllabus which may cause difficulties because of differences between the actual trainee entry level and that assumed by the course designers should be identified. To compensate for such differences, the instructor is expected to delete from the course, or to reduce the emphasis on, items dealing with knowledge or skills already attained by the trainees. They should also identify any academic knowledge, skills or technical training which they may not have acquired.

Though lecture and demonstration time may be adjusted to better suit class and student needs based on previous experience; care should be taken not to alter or abbreviate practical assessments. As an Advanced Level Course, these assessments establish trainee baseline competency and represent the MINIMUM knowledge required for the subject. The instructor, using his/her professional judgment, can analyze the detailed syllabus and the academic knowledge required to allow training in the technical area to proceed. The instructor can then design the appropriate pre-entry course or, alternatively, insert the elements of academic knowledge required to support the technical training elements concerned at appropriate points within the technical course.

This course is designed to follow the requirements of the STCW convention including the 2010 Manila amendments, and builds upon the knowledge and skills included in the IMO Model course 1.01 – "Basic training for oil and chemical tanker cargo operations" The diagrams and learning objectives included in the Basic course may also be used to assist in the making of presentations for the advanced training in oil tanker operations course.

Adjustment of the course objective, scope and content may also be necessary if in a country's maritime industry the trainees completing the course are to undertake duties which differ from the course objective specified in this model course.

Within the course plan the course designers have indicated assessment of the time that should be allotted to each area of learning. However, it must be appreciated that these allocations are arbitrary and assume that the trainees have fully met all entry requirements of the course. The instructor should therefore review these assessments and may need to reallocate the time required to achieve each specific learning objective or training outcome.

## ■ Aims

This course provides training to candidates to meet the requirements of Section A - V/1-1 para. 2 of the STCW Code with specific duties for loading, unloading and care in transit or handling of oil cargoes. It comprises an advanced training programme appropriate to their duties, including oil tanker safety, fire safety measures, pollution prevention, operational practice and obligations under applicable

law and regulations. The course covers the competence requirements as given in the table under Section A-V/1-1-2 of the STCW Code adopted by the International Convention on Standards of Training, Certification and Watchkeeping for Seafarers, as amended.

During the course, there will be:

- Familiarization with the equipment, instrumentation and controls used for cargo handling on an oil tanker
- A greater awareness of the need of proper planning, the use of checklists and the time scales involved in the various cargo handling operations
- An enhanced awareness to apply proper and safe procedures at all times when carrying out the various operations on board an oil tanker
- An acquisition of experience in identifying operational problems and assist in solving them.
- An improvement in the ability to promote safety and protect the marine environment
- An increased ability to assist and co-ordinate actions during emergencies

#### ■ **Lesson plans**

After adjusting the course content, if so required, to suit the trainee intake and any revision of the course objectives, the instructor can then draw up lesson plans based on the detailed syllabus. Where no adjustment has been found necessary by learning objectives of the detailed syllabus, the lesson plans may simply consist of the detailed syllabus with keywords or other reminders added to assist the instructor in making his/her presentation of the material.

#### ■ **Presentation**

The presentation of concepts and methodologies must be repeated in various ways until testing and evaluating the trainee's performance and achievements satisfy the instructor, that the trainee has attained the required proficiency under each specific learning objective or training objective. The syllabus is laid out in the form of acquiring knowledge, understanding and proficiency format and each objective specifies what the trainee must be able to do as the learning or training outcome. Taken as a whole, these objectives aim to meet the knowledge, understanding and proficiency specified in the appropriate tables of the STCW Code.

#### ■ **Implementation**

For the course, to run smoothly and to be effective, considerable attention must be paid to the availability and use of:

- Properly qualified instructors
- Support staff
- Rooms and other spaces
- Simulators and other Equipment
- Textbooks, technical papers, and
- Other reference material



Thorough preparation on part of the instructor is the key to successful implementation of the course. IMO has produced a booklet entitled "Guidance on the Implementation of IMO Model Courses", which deals with this aspect in greater detail and which is appended to this model course.

In certain cases, the requirements for some or all of the training in a subject are covered by another IMO model course. In these cases, the specific part of the STCW Code which applies is given and the user is referred to the other model course.

## **Part A: Course Framework**

### **■ Scope**

This course provides training for Masters, chief engineer officers, chief mates, second engineer officers and any person with immediate responsibility for loading, unloading care in transit, handling of cargo, tank cleaning or other cargo related operations on oil tankers. It comprises an advanced training programme appropriate to their duties on oil tankers for their ability to imbibe a safety culture to perform & monitor all cargo operations, the properties of oil cargoes, take precautions to prevent hazards, apply health & safety precautions, respond to emergencies fire safety measures, take precautions to prevent pollution of the environment, and monitor & control compliance with legislative requirements. The course takes full account of Section A-V/1-1 para. 2 of the STCW Code adopted by the International Convention on Standards of Training, Certification and Watch keeping for Seafarers, as amended.

This training may be given on board or ashore. It can be supplemented by practical training on board or wherever possible on simulators in training institutions or in a suitable shore-based installation.

### **■ Objective**

Those successfully completing the Advanced training in oil tanker cargo operations course should therefore meet the training requirements in accordance with Regulation A-V/1-1 para. 2.2.

### **■ Entry standards**

This course is open for any person who intends to have immediate responsibility for loading, unloading care in transit, handling of cargo, tank cleaning or other cargo related operations on oil tankers. It comprises of seafarers who have qualified in accordance with Regulation V/1-1 para. 2.2 of the International Convention on Standards of Training, Certification and Watch keeping for Seafarers, as amended.

### **■ Course certificate**

. Upon successful completion of the course, the trainee should be issued a course completion document for "Advanced training for oil tanker cargo operations".

### **■ Course intake limitations**

It is recommended that the number of trainees should not exceed 20 and practical training should be undertaken in small groups of not more than eight.

### **■ Staff requirements**

The instructor shall have appropriate training in instructional techniques and training methods (STCW Code, Section A-I/6, para. 7). It is recommended that all training and

instruction is given by qualified personnel experienced in the handling and characteristics of oil cargoes and the safety procedures involved. Staff may be recruited among deck and engineer officers of oil tankers, and/or fleet superintendents as appropriate.

## ■ Teaching facilities and equipment

Ordinary classroom facilities and an overhead projector are sufficient for most of the Course. However, dedicated CBT modules to be run on an ordinary PC as well as exercises on an operational, hands-on liquid cargo handling simulator, will greatly enhance the quality and result of the course. In such cases sufficient PCs for use by one or two trainees will be required. In addition, a video player will be required if using videos in the teaching programme.

The following equipment should be available:

1. Resuscitator
2. Breathing apparatus
3. Portable oxygen meter
4. Portable combustible-gas detector
5. Portable tankscope/Multi point flammable gas (infra- red gas analyzer)
6. Portable toxic-gas detector & chemical absorption tubes
7. Portable multigas – detector
8. Personal multigas – detector
9. Tank evacuation equipment.

Due to the relatively high cost of obtaining and maintaining items 3-8 and the availability of simulators with reasonable facsimiles, respective Administrations may approve the use of simulators to replace some or all of the gas measuring equipment provided that the training and competency assessments can be thoroughly and ACCURATELY completed through the use of designed simulation.

## ■ Use of Simulators

The STCW Convention as amended sets standards regarding the performance and use of simulators for mandatory training, assessment or demonstration of competence. The general performance standards for simulators used in training and for simulators used in assessment of competence are given in Section A-I/12. Simulator -based training and assessment is not a mandatory requirement for this "Advanced training for oil tanker cargo operations" course. However, it is widely recognized that well-designed lessons and exercises can improve the effectiveness of training.

If using simulator-based training, instructors should ensure that the aims and objective of these sessions are defined within the overall training programme and that tasks are selected so as to relate as closely as possible to shipboard tasks and practices. Instructors should refer to STCW, Section A-I/12, Part 1 and 2.

Note: Administrations may require additional training at sea or ashore to meet national regulations.

## ■ Design

The core technical and academic knowledge, understanding and proficiency are set out in Table A-V/1-1-2 of the STCW, which was adopted by IMO as part of the 2010 STCW Convention as shown below:

The content of the Model course is designed to suit the trainers teaching this course for optimum delivery, ensuring a high degree of consistency and adherence to STCW, as amended, standards leading to certification in advanced training for oil tanker cargo operations.

The flow of topics mentioned in Part C, is thus reflecting, how the trainer should design their course and delivery and is for guidance only.

To show consistency and adherence to STCW, as amended as given in table A-V/1-1-2, a mapping is provided below for easy reference from STCW's competences and training outcomes to the topics covered in this Model course.

**The STCW 2010 Table A-V/1-1-2 Mapping of IMO Model course 1.02 topics**

**STCW 2010 Table A-V/1-1-2 Mapping of IMO Model course 1.02 topics**

STCW 2010 Table A-V/1-1-2			IMO Model course 1.02		
S. No	Competence	Knowledge, Understanding and Proficiency	S. No	Topic	Knowledge, Understanding and Proficiency
1	Ability to safely perform and monitor all cargo operations	<p><b>1.0 Knowledge of oil tanker design, systems and equipment</b></p> <p>1.1 General arrangement and construction</p> <p>1.2 Pumping arrangement and equipment</p> <p>1.3 Tank arrangement, pipeline system and tank venting arrangement</p> <p>1.4 Gauging systems and alarms</p> <p>1.5 Cargo heating systems</p> <p>1.6 Tank cleaning, gas freeing and inerting systems</p> <p>1.7 Ballast system</p> <p>1.8 Cargo area venting and accommodation ventilation</p> <p>1.9 Slop arrangements</p> <p>1.10 Vapour recovery systems</p> <p>1.11 Cargo-related electrical and electronic control system</p> <p>1.12 Environmental protection equipment, including Oil</p>	1	Knowledge of oil tanker design, systems and equipment*	<p>1.1 General arrangement and construction</p> <p>1.2 Pumping arrangement and equipment</p> <p>1.3 Tank arrangement, pipeline system and tank venting arrangement</p> <p>1.4 Gauging systems and alarms</p> <p>1.5 Cargo heating systems</p> <p>1.6 Tank cleaning, gas freeing and inerting systems</p> <p>1.7 Ballast system</p> <p>1.8 Cargo area venting and accommodation ventilation</p> <p>1.9 Slop arrangements</p> <p>1.10 Vapour recovery systems</p> <p>1.11 Cargo-related electrical and electronic control system</p> <p>1.12 Environmental protection equipment, including Oil Discharge Monitoring</p>

STCW 2010 Table A-V/1-1-2			IMO Model course 1.02		
S. No	Competence	Knowledge, Understanding and Proficiency	S. No	Topic	Knowledge, Understanding and Proficiency
		Discharge Monitoring Equipment (ODME) 1.13 Tank coating 1.14 Tank temperature and pressure control systems 1.15 Fire-fighting systems			Equipment (ODME) 1.13 Tank coating 1.14 Tank temperature and pressure control systems 1.15 Fire-fighting systems
		<b>2.0 Knowledge of pump theory and characteristics, including types of cargo pumps and their safe operation</b>	<b>2</b>	<b>Knowledge of pump theory and characteristics, including types of cargo pumps and their safe operation</b>	2.1 Pump theory and characteristics including types of cargo pumps 2.2 Pressure Surge
		<b>3.0 Proficiency in tanker safety culture and implementation of safety-management system</b>	<b>3</b>	<b>Proficiency in tanker safety culture and implementation of safety-management system</b>	
		<b>4.0 Knowledge and understanding of monitoring and safety systems, including the emergency shutdown</b>	<b>4</b>	<b>Knowledge and understanding of monitoring and safety systems, including the emergency shutdown</b>	

STCW 2010 Table A-V/1-1-2			IMO Model course 1.02		
S. No	Competence	Knowledge, Understanding and Proficiency	S. No	Topic	Knowledge, Understanding and Proficiency
		<b>5.0 Loading, unloading, care and handling of cargo</b>	<b>5</b>	<b>Loading, unloading, care and handling of cargo</b>	<b>5.1 Ability to perform cargo measurements and calculations</b>
		<b>6.0 Knowledge of the effect of bulk liquid cargoes on trim, stability and structural integrity</b>	<b>6</b>	<b>Knowledge of the effect of bulk liquid cargoes on trim, stability and structural integrity</b>	
		<b>7.0 Knowledge and understanding of oil cargo related operations</b> 7.1 Loading and unloading plans 7.2 Ballasting and Deballasting 7.3 Tank cleaning operations 7.4 Inerting 7.5 Gas-freeing 7.6 Ship-to-ship transfers 7.7 Load on top 7.8 Crude oil washing	<b>7</b>	<b>Knowledge and understanding of oil cargo related operations</b>	7.1 Loading and unloading plans 7.2 Ballasting and Deballasting 7.3 Tank cleaning operations 7.4 Inerting 7.5 Gas-freeing 7.6 Ship-to-ship transfers 7.7 Load on top 7.8 Crude oil washing
		<b>8.0 Development and application of cargo-related operation plans, procedures and checklists</b>	<b>8</b>	<b>Development and application of cargo-related operation plans, procedures and checklists</b>	



STCW 2010 Table A-V/1-1-2			IMO Model course 1.02		
S. No	Competence	Knowledge, Understanding and Proficiency	S. No	Topic	Knowledge, Understanding and Proficiency
		<b>9.0 Ability to calibrate and use monitoring and gas-detection systems, instruments and equipment</b>	<b>9</b>	<b>Ability to calibrate and use monitoring and gas-detection systems, instruments and equipment</b>	
		<b>10.0 Ability to manage and supervise personnel with cargo-related responsibilities</b>	<b>10</b>	<b>Ability to manage and supervise personnel with cargo-related responsibilities</b>	
<b>2</b>	Familiarity with physical and chemical properties of oil cargoes	<b>11.0 Knowledge and understanding of the physical and chemical properties of oil cargoes</b> 11.1 Physical Properties 11.2 Chemical Properties 11.3 Understanding the information contained in a Material Safety Data Sheet (MSDS)	<b>11</b>	<b>Knowledge and understanding of the physical and chemical properties of oil cargoes</b>	11.1 Physical Properties 11.2 Chemical Properties 11.3 Understanding the information contained in a Material Safety Data Sheet (MSDS)
<b>3</b>	Take precautions to prevent hazards	<b>12.0 Knowledge and understanding of the hazards and control measures associated with oil tanker cargo operations</b>	<b>12</b>	<b>Knowledge and understanding of the hazards and control measures associated with oil tanker cargo operations</b>	12.1 Toxicity 12.2 Flammability and Explosion 12.3 Health Hazards 12.4 Inert Gas Composition 12.5 Electrostatic Hazards

STCW 2010 Table A-V/1-1-2			IMO Model course 1.02		
S. No	Competence	Knowledge, Understanding and Proficiency	S. No	Topic	Knowledge, Understanding and Proficiency
		12.1 Toxicity 12.2 Flammability and Explosion 12.3 Health Hazards 12.4 Inert Gas Composition 12.5 Electrostatic Hazards 12.6 Knowledge and understanding of dangers of non-compliance with relevant rules/regulations			12.6 Oxygen deficiency 12.7 Knowledge and understanding of dangers of non-compliance with relevant rules / regulations
4	Apply occupational health and safety precautions	<b>13.0 Knowledge and understanding of safe working practices, including risk assessment and personal shipboard safety relevant to oil tankers:</b>  13.1 Precautions to be taken when entering enclosed spaces, including correct use of different types of breathing apparatus. 13.2 Precautions to be taken before and during repairs and maintenance work 13.3 Precautions for hot and cold work	13	<b>Knowledge and understanding of safe working practices, including risk assessment and personal shipboard safety relevant to oil tankers:</b>	13.1 Precautions to be taken when entering enclosed spaces, including correct use of different types of breathing apparatus. 13.2 Precautions to be taken before and during repairs and maintenance work 13.3 Precautions for hot and cold work 13.4 Precautions for electrical safety 13.5 Use of appropriate Personal Protective Equipment.(PPE)

STCW 2010 Table A-V/1-1-2			IMO Model course 1.02		
S. No	Competence	Knowledge, Understanding and Proficiency	S. No	Topic	Knowledge, Understanding and Proficiency
		13.4 Precautions for electrical safety 13.5 Use of appropriate Personal Protective Equipment.(PPE)			
5	Respond to emergencies	<b>14.0 Knowledge and understanding of oil tanker emergency procedures</b> 14.1 Ship emergency response plan 14.2 Cargo operations emergency shut down 14.3 Actions to be taken in the event of failure of systems or services essential to cargo 14.4 Firefighting on oil tankers 14.5 Enclosed space rescue 14.6 Use of Material Safety data sheet (MSDS)	14	<b>Knowledge and understanding of oil tanker emergency procedures</b>	14.1 Ship emergency response plan 14.2 Cargo operations emergency shut down 14.3 Actions to be taken in the event of failure of systems or services essential to cargo 14.4 Firefighting on oil tankers 14.5 Enclosed space rescue 14.6 Use of Material Safety data sheet (MSDS)
		<b>15.0 Actions to be taken following collision, grounding, or spillage</b>	15	<b>Actions to be taken following collision, grounding, or spillage</b>	
		<b>16.0 Knowledge of medical first aid procedures on board oil tankers</b>	16	<b>Knowledge of medical first aid procedures on board oil tankers</b>	

STCW 2010 Table A-V/1-1-2			IMO Model course 1.02		
S. No	Competence	Knowledge, Understanding and Proficiency	S. No	Topic	Knowledge, Understanding and Proficiency
6	Take precautions to prevent pollution of the environment	<b>17.0 Understanding of procedures to prevent pollution of the atmosphere and the environment</b>	17	<b>Understanding of procedures to prevent pollution of the atmosphere and the environment</b>	17.1 Pollution prevention requirements of Ship's construction and equipment 17.2 Controlled operational pollution at sea 17.3 Prevention of pollution in port 17.4 Importance of the Oil Record Book (ORB) for pollution prevention 17.5 Air pollution
7	Monitor and control compliance with legislative requirements	<b>18.0 Knowledge and understanding of relevant provisions of the International Convention for the Prevention of Pollution from Ships (MARPOL), as amended, and other relevant IMO instruments, industry guidelines and port regulations as commonly applied</b>	18	<b>Knowledge and understanding of relevant provisions of the International Convention for the Prevention of Pollution from Ships (MARPOL), as amended, and other relevant IMO instruments, industry guidelines and port regulations as commonly applied</b>	

## ■ Teaching Aids (A)

Note: - Other equivalent teaching aids may be used as deemed fit by the instructor.

- A1 Instructor's Manual (Part D of this course)
- A2 Resuscitator
- A3 Breathing apparatus
- A4 Portable oxygen meter
- A5 Portable combustible-gas detector
- A6 Portable tankscope/Multi point flammable gas (infra-red gas analyzer)
- A7 Portable toxic-gas detector & chemical absorption tubes
- A8 Portable multigas – detector
- A9 Personal multigas – detector
- A10 Tank evacuation equipment.
- A11 Overhead projector for power point presentations
- A12 Oil Tanker Cargo & Ballast Water Handling Simulator
- A13 White board
- A14 Videos

Due to the relatively high cost of obtaining and maintaining items A4 – A9 and the availability of simulators with reasonable facsimiles, respective Administrations may approve the use of simulators to replace some or all of the gas measuring equipment provided that the training and competency assessments can be thoroughly and ACCURATELY completed through the use of designed simulation.

## ■ IMO references (R)

- R1 SOLAS 1974, International Convention for the Safety of Life at Sea, 1974 (SOLAS 1974) Consolidated Edition 2009, (IMO-IIOE)
- R2 STCW 78 as amended, including 2010 Manila amendments, International Convention on Standards of Training, Certification and Watchkeeping for Seafarers
- R3 MARPOL as amended, International Convention for the Prevention of Pollution from Ships, 1973/1978(MARPOL as amended) Consolidated Edition 2011. (IMO-ID520E)
- R4 IG Systems, Inert Gas Systems, 1990 Edition (IMO-I860E)
- R5 Medical First aid guide for use in accidents involving dangerous goods (MFAG)
- R6 ISM Code, International Safety Management Code (ISM Code) (IMO-117E)
- R7 International Code for Fire Safety Systems, 2007 Edition, including Supplement 2012 (IMO-IA155E)
- R8 Crude Oil Washing Systems, 2000 Edition (IMO-IA617E)

## ■ Textbooks (T)

Note: - Other textbooks may be used as deemed fit by the instructor.

- T1 Safety in Oil Tankers, International Chamber of Shipping, Safety in Oil Tankers. (International Chamber of Shipping, Carthusian Court, 12 Carthusian Street, London, EC1M 6EZ, U.K.)

■ **Bibliography (B)**

- B1 International Safety Guide for Oil Tankers and Terminals. 5th ed. [London, Witherby and Co. Ltd. (32/36 Aylesbury Street, London, EC1R 0ET, U.K),1996] (ISBN 1-85609-081-7)
- B2 Safe Oil Tanker operations, Safe Oil Tanker operations 2011 edition  
Capt. K.S.D Mistree & Mr. BK Sharma. - MARINEX Publications. A-3, Silver Queen, Soonawala Agyarimarg, Mumbai 445470, India. e-mail: marinez1@hotmail.com Tel: 91 22 24465470
- B3 Ship to Ship Transfer Guide (Petroleum), International Chamber of Shipping/Oil Companies International Marine Forum, Ship to Ship Transfer Guide (Petroleum), 4th ed. (London, Witherby& Co. Ltd., 2005) (ISBN 1-85609-097-3)
- B4 Drager-Tube Handbook, Drager-Tube Handbook 11th ed. (Drager Sicherheitstechnik GmbH, Revalstrasse 1, D-23560 Lubeck, Germany, 1998) (ISBN 3-926762-06-3)
- B5 Measures to Prevent Accidental Pollution, INTERTANKO, Measures to Prevent Accidental Pollution, 1990
- B6 Code of Safe Working Practices, Consolidated Edition 2010, TSO Information and Publishing Solutions, PO Box 29, Norwich NR3 1GN, U.K., www.tso.co.uk, ISBN 978-0-11-553170-5
- B7 OCIMF's Tanker Management Self Assessment, TMSA 2, Witherby Publications, 32/36 Aylesbury street, London. www.witherbyseamanship.com ISBN 10: 1905331231 ISBN 13: 9781905331239

■ **Videos - DVDs, CD ROMs, CBT's (V)**

Note: - Other equivalent videos, CD-ROMs, CBT's may be used as deemed fit by the instructor.

- VO1 Portable gas detection equipment calibration procedures  
**Available from:** **KARCO**  
**Website:**<http://www.karco.in>  
**e-mail ID:**[karco@karcoservices.com](mailto:karco@karcoservices.com)  
Contact Person: Capt Pravesh Diwan  
Telephone: 91-22-67101229
- VO2 Tanker safety depends on you  
Available from: NATIONAL AUDIO VISUAL CENTER  
National Technical Information Service  
5301 Shawnee Rd, Alexandria  
VA 22312  
e-mail: [orders@ntis.gov](mailto:orders@ntis.gov)
- VO3 Operation and maintenance of inert gas systems
- VO4 The ship/shore interface – petroleum tankers
- VO5 Tanker practices series
- cargo - part 4 Code No: 504
- VO6 Permit to work Code No: 621
- VO7 Entry into enclosed spaces (edition 2) Code No: 682

- VO8 Personal safety on tankers (edition 2), Code No: 970  
Available from: Videotel Marine International  
84 Newman Street, London W1T 3EU, UK  
Tel: +44(0) 20 72991800  
Fax: +44(0) 207299 1818  
e-mail: mail@videotelmail.com  
URL: www.videotel.co.uk
- VO9 FRAMO cargo pumping system - instruction video vi
- VO10 Operation of FRAMO cargo pumping system - instruction video vii  
Available from: Head Office- Frank Mohn Services AS,  
PO Box 98, Slatthaug, 5851 Bergen, Norway.  
Phone: +4755999000.  
URL: www.framo.no
- VO11 Static electricity on board tankers - DVD  
Available from: KARCO  
Website: <http://www.karco.in>  
e-mail ID: karco@karcoservices.com  
Contact Person: Capt. Pravesh Diwan  
Telephone: 91-22-67101229
- VO12 Vapour emission control Code No: 1118
- VO13 CBT's from Seagull:-
- Liquid cargo properties (CBT # 0032)
  - COW (CBT # 0054)
  - ODME (CBT # 0055)
- V014 Crude Oil Washing Operations (Edition 3) Code no. 707  
Available from: Videotel Marine International
- 84 Newman Street, London W1T 3EU, UK
  - Tel: +44(0) 20 72991800
  - Fax: +44(0) 207299 1818
  - e-mail: mail@videotelmail.com
  - URL: www.videotel.co.uk

## **Part B: Course Outline and Timetable**

### **■ Lectures**

As far as possible, lectures should be presented within a familiar context and should make use of practical examples. They should be well illustrated with diagrams, photographs and charts where appropriate, and be related to matter learned during seagoing time.

An effective manner of presentation is to develop a technique of giving information and then reinforcing it. For example, first tell the trainees briefly what you are going to present to them; then cover the topic in detail; and, finally, summarize what you have told them. The use of an overhead projector and the distribution of copies of the presentation as trainees handouts contribute to the learning process.

### **● Course Outline**

The tables that follow list the competencies and areas of knowledge, understanding and proficiency, together with the estimated total hours required for lectures and practical exercises. There are seven competences which are sub-divided into eighteen primary areas of knowledge, understanding and proficiency.

Teaching staff should note that timings are suggestions only and should be adapted to suit individual groups of trainees depending on their experience, ability, equipment and staff available for training.



## COURSE OUTLINE

Knowledge, understanding and proficiency	Total hours for lectures	Total hours for practicals
<b>COMPETENCE: Ability to Safely Perform and Monitor All Cargo Operations</b>		3.0
<b>1 Knowledge of oil tanker design, systems and equipment(*)</b>		
1.1 General arrangement and construction(*)	0.4	
1.2 Pumping arrangement and equipment(*)	0.1	
1.3 Tank arrangement, pipeline system and tank venting arrangement(*)	0.6	
1.4 Gauging systems and alarms(*)	0.3	
1.5 Cargo heating systems(*)	0.2	
1.6 Tank cleaning, gas-freeing and inerting systems (*)	1.0	
1.7 Ballast system(*)	0.1	
1.8 Cargo area venting and accommodation ventilation(*)	0.1	
1.9 Slop arrangements(*)	0.1	
1.10 Vapour recovery systems(*)	0.2	
1.11 Cargo-related electrical and electronic control system(*)	0.2	
1.12 Environmental protection equipment, including Oil Discharge Monitoring Equipment (ODME)(*)	0.2	
1.13 Tank coating	0.1	
1.14 Tank temperature and pressure control systems(*)	0.2	
1.15 Fire-fighting systems	0.2	
<b>2 Knowledge of pump theory and characteristics, including types of cargo pumps and their safe operation</b>		
2.1 Pump theory and characteristics including types of cargo pumps	2.5	
2.2 Pressure Surge	0.5	
<b>3 Proficiency in tanker safety culture and implementation of safety-management system(**)</b>	0.75	

	<b>Knowledge, understanding and proficiency</b>	<b>Total hours for lectures</b>	<b>Total hours for practicals</b>
4	<b>Knowledge and understanding of monitoring and safety systems, including the emergency shutdown</b>	1.5	
5	<b>Loading, unloading, care and handling of cargo</b>	1.5	1.5
	5.1 Ability to perform cargo measurements and calculations(#)		
6	<b>Knowledge of the effect of bulk liquid cargoes on trim, stability and structural integrity(*)</b>	<b>0.5</b>	2.0
7	<b>Knowledge and understanding of oil cargo related operations</b>		
	7.1 Loading and unloading plans (*)	3.0	3.0
	7.2 Ballasting and Deballasting(*)	1.5	
	7.3 Tank cleaning operations(*)	1.5	
	7.4 Inerting(*)		1.5
	7.5 Gas-freeing(*)	1.0	
	7.6 Ship-to-ship transfers	1.5	
	7.7 Load on top(*)	0.5	
	7.8 Crude oil washing(*)	0.5	1.0
8	<b>Development and application of cargo-related operation plans, procedures and checklists(**)</b>	1.5	
9	<b>Ability to calibrate and use monitoring and gas-detection systems, instruments and equipment(#)</b>	1.0	0.5
10	<b>Ability to manage and supervise personnel with cargo-related responsibilities</b>	0.5	
	<b>COMPETENCE: Familiarity with Physical and Chemical Properties of Oil Cargoes</b>		
11	<b>Knowledge and understanding of the physical and chemical properties of oil cargoes</b>		
	11.1 Physical Properties	0.5	
	11.2 Chemical Properties	0.5	
	11.3 Understanding the information contained in a Safety Data Sheet (SDS)(#)		1.0
	<b>COMPETENCE: Take Precautions to Prevent Hazards</b>		

<b>Knowledge, understanding and proficiency</b>		<b>Total hours for lectures</b>	<b>Total hours for practicals</b>
<b>12</b>	<b>Knowledge and understanding of the hazards and control measures associated with oil tanker cargo operations</b>		
12.1	Toxicity	0.5	
12.2	Flammability and Explosion	0.5	
12.3	Health Hazards	0.5	
12.4	Inert Gas Composition	0.5	
12.5	Electrostatic Hazards	0.5	
12.6	Oxygen deficiency	0.5	
12.7	Knowledge and understanding of dangers of non-compliance with relevant rules/regulations	1.0	
	<b>COMPETENCE: Apply Occupational Health and Safety Precautions</b>		
<b>13</b>	<b>Knowledge and understanding of safe working practices, including risk assessment and personal shipboard safety relevant to oil tankers:</b>		
13.1	Precautions to be taken when entering enclosed spaces, including correct use of different types of breathing apparatus(**).	0.5	
13.2	Precautions to be taken before and during repairs and maintenance work	0.25	
13.3	Precautions for hot and cold work	0.25	
13.4	Precautions for electrical safety	0.25	
13.5	Use of appropriate Personal Protective Equipment.(PPE)(#)	0.25	
	<b>COMPETENCE: Respond to Emergencies</b>		
<b>14</b>	<b>Knowledge and understanding of oil tanker emergency procedures</b>		
14.1	Ship emergency response plan	0.25	
14.2	Cargo Operations emergency shut down	0.12	
14.3	Actions to be taken in the event of failure of systems or services essential to cargo	0.12	
14.4	Firefighting on oil tankers(**)	0.25	
14.5	Enclosed space rescue	0.25	
14.6	Use of Material Safety data sheet (MSDS)	0.25	
<b>15</b>	<b>Actions to be taken following collision, grounding, or spillage</b>	0.25	

	<b>Knowledge, understanding and proficiency</b>	<b>Total hours for lectures</b>	<b>Total hours for practicals</b>
<b>16</b>	<b>Knowledge of medical first aid procedures on board oil tankers</b>	1.5	
	<b>COMPETENCE: Take Precautions to Prevent Pollution of the Environment</b>		
<b>17</b>	<b>Understanding of procedures to prevent pollution of the atmosphere and the environment</b>	1.5	
<b>18</b>	<b>Knowledge and understanding of relevant provisions of the International Convention for the Prevention of Pollution from Ships (MARPOL), as amended, and other relevant IMO instruments, industry guidelines and port regulations as commonly applied</b>	1.5	
<b>19</b>	<b>Case Studies</b>	3.0	
<b>20</b>	<b>Test and Discussion</b>	0.5	
	<b>Subtotals</b>	<b>46</b>	<b>14</b>
	<b>Total for the course</b>		<b>60</b>

#### **Notes**

It is suggested that relevant topics which are marked with an Asterisk (\*) may be taught on a simulator.

It is suggested that relevant topics which are marked with a Hash (#) may be conducted separately in any facility which can conduct practical exercises and instruction under approved and truly realistic training conditions (e.g., simulated shipboard conditions).

It is suggested that relevant topics which are marked with a double Asterisk (\*\*) may be demonstrated practically or relevant videos to be shown for same.

---

Teaching staff should note that the hours for lectures and exercises are suggestions only as regards sequence and length of time allocated to each objective. These factors may be adapted by lecturers to suit individual groups of trainees depending on their experience, ability, equipment and staff available for teaching.

---

## Course Timetable

The following timetable should be considered indicative and adjusted in accordance with the needs of course participants. The topics should be covered, but with sufficient flexibility with respect to extent and depth that takes into account the differing learning needs of the participants.

<b>Day 1</b>	<ul style="list-style-type: none"> <li>1.0 Knowledge of oil tanker design, systems and equipment</li> <li>1.1 general arrangement and construction</li> <li>1.2 pumping arrangement and equipment</li> <li>1.3 tank arrangement, pipeline system and tank venting arrangement</li> <li>1.4 gauging systems and alarms</li> <li>1.5 cargo heating systems</li> <li>1.6 tank cleaning, gas-freeing and inerting systems</li> </ul>
<b>Day 2</b>	<ul style="list-style-type: none"> <li>1.8 Cargo area venting and accommodation ventilation</li> <li>1.9 Slop arrangements</li> <li>1.10 Vapour recovery systems</li> <li>1.11 cargo-related electrical and electronic control system</li> <li>1.12 environmental protection equipment, including Oil Discharge Monitoring Equipment (ODME)</li> <li>1.13 tank coating</li> <li>1.14 tank temperature and pressure control systems (*)</li> <li>1.15 fire-fighting systems</li> <li>2.0 Knowledge of pump theory and characteristics, including types of cargo pumps and their safe operation</li> <li>2.1 Pump theory and characteristics</li> </ul>
<b>Day 3</b>	<ul style="list-style-type: none"> <li>2.1 Pump theory and characteristics including types of cargo pumps (cont.)</li> <li>2.2 Pressure Surge</li> <li>3.0 Proficiency in tanker safety culture and implementation of safety-management system</li> <li>4.0 Knowledge and understanding of monitoring and safety systems, including the emergency shutdown</li> </ul>
<b>Day 4</b>	<ul style="list-style-type: none"> <li>5.0 Loading unloading, care and handling of cargo</li> <li>5.1 Ability to perform cargo measurements and calculations</li> <li>6.0 Knowledge of the effect of bulk liquid cargoes on trim, stability and structural integrity</li> </ul>
<b>Day 5</b>	<ul style="list-style-type: none"> <li>9.0 Ability to calibrate and use monitoring and gas-detection systems, instruments and equipment</li> <li>11.0 Knowledge and understanding of the physical and chemical properties of oil cargoes</li> <li>11.1 Physical Properties</li> <li>11.2 Chemical Properties</li> <li>11.3 Understanding the information contained in a Material Safety Data Sheet (MSDS)</li> <li>10.0 Ability to manage and supervise personnel with cargo-related responsibilities</li> <li>1.7 Ballast System</li> </ul>
<b>Day 6</b>	<ul style="list-style-type: none"> <li>12.0 Knowledge and understanding of the hazards and control measures associated with oil tanker cargo operations,</li> <li>12.1 Toxicity</li> <li>12.2 Flammability and Explosion</li> <li>12.3 Health Hazards</li> </ul>

	<p>12.0 Knowledge and understanding of the hazards and control measures associated with oil tanker cargo operations,</p> <p>12.4 Inert Gas Composition</p> <p>12.5 Electrostatic Hazards</p> <p>12.6 Oxygen deficiency</p> <p>13.0 Knowledge and understanding of safe working practices, including risk assessment and personal shipboard safety relevant to oil tankers:</p> <p>13.1 Precautions to be taken when entering enclosed spaces, including correct use of different types of breathing apparatus</p> <p>13.2 Precautions to be taken before and during repairs and maintenance work</p> <p>13.3 Precautions for hot and cold work</p> <p>13.4 Precautions for electrical safety</p> <p>13.5 Use of appropriate Personal Protective Equipment.(PPE)</p> <p>8.0 Development and application of cargo-related operation plans, procedures and checklists</p>
<b>Day 7</b>	<p>7.4 inerting</p> <p>7.1 loading and unloading plans</p>
<b>Day 8</b>	<p>7.1 loading and unloading plans</p> <p>7.3 tank cleaning operations</p> <p>7.8 crude oil washing</p> <p>7.7 Load on top</p> <p>7.5 gas-freeing</p>
<b>Day 9</b>	<p>7.2 Ballasting and Deballasting</p> <p>7.6 Ship-to-ship transfers</p> <p>16.0 Knowledge of medical first aid procedures on board oil tankers</p> <p>14.0 Knowledge and understanding of oil tanker emergency procedures</p> <p>14.1 Ship emergency response plan</p> <p>14.2 Cargo Operations emergency shut down</p> <p>14.3 Actions to be taken in the event of failure of systems or services essential to cargo</p> <p>14.4 Firefighting on oil tankers(**)</p> <p>14.5 Enclosed space Rescue</p> <p>14.6 Use of Material Safety data sheet (MSDS)</p> <p>15.0 Actions to be taken following collision, grounding, or spillage</p>
<b>Day 10</b>	<p>17.0 Understanding of procedures to prevent pollution of the atmosphere and the environment</p> <p>17.1 Pollution prevention requirements of Ship's construction and equipment</p> <p>17.2 Controlled operational pollution at sea</p> <p>17.3 Prevention of pollution In port</p> <p>17.4 Importance of the Oil Record Book (ORB) for pollution prevention</p> <p>17.5 Air pollution</p> <p>18.0 Knowledge and understanding of relevant provisions of the International Convention for the Prevention of Pollution from Ships (MARPOL), as amended, and other relevant IMO instruments, industry guidelines and port regulations as commonly applied</p> <p>19.0 Case studies</p> <p>12.7 Knowledge and understanding of dangers of non-compliance with relevant rules/regulations</p>

Note: Teaching staff should note timetables are suggestions only as regards sequence and length of time allocated to each objective. These factors may be adapted by instructors to suit individual groups of trainees depending on their experience and ability balanced with the equipment and staff available for training. Though lecture and demonstration time may be adjusted to better suit class and student needs based on previous experience; care should be taken not to alter or abbreviate practical assessments.

## Part C: Detailed Teaching Syllabus

### ■ Introduction

The detailed teaching syllabus is presented as a series of learning objectives. The objective, therefore, describes what the trainee must do to demonstrate that the specified knowledge or skill has been transferred.

Thus each training outcome is supported by a number of related performance elements in which the trainee is required to be proficient. The teaching syllabus shows the *required performance* expected of the trainee in the tables that follow.

In order to assist the instructor, references are shown to indicate IMO references and publications, textbooks and teaching aids that instructors may wish to use in preparing and presenting their lessons.

The material listed in the course framework has been used to structure the detailed teaching syllabus; in particular,

- o Teaching aids (indicated by A) which includes:
- o IMO references (indicated by R)
- o Textbooks (indicated by T) and
- o Bibliography (indicated by B)

which will provide valuable information to instructors.



---

**COMPETENCE 1 Ability to safely perform and monitor all cargo operations**

---

**TOPIC 1 DESIGN AND CHARACTERISTICS OF AN OIL TANKER**

---

**TRAINING OUTCOMES:**

Demonstrates knowledge, understanding and proficiency of :

- 1. Oil tanker design, systems and equipment including:**
  - .1 General arrangement and construction
  - .2 Pumping arrangement and equipment
  - .3 Tank arrangement, pipeline system and tank venting arrangement
  - .4 Gauging systems and alarms
  - .5 Cargo heating systems
  - .6 Tank cleaning, inerting and Gas freeing systems
  - .7 Ballast system
  - .8 Cargo area venting and accommodation ventilation
  - .9 Slop arrangements
  - .10 Vapour recovery systems
  - .11 Cargo-related electrical and electronic control system
  - .12 Environmental protection equipment, including Oil Discharge Monitoring Equipment (ODME)
  - .13 Tank coating
  - .14 Tank temperature and pressure control systems
  - .15 Fire-fighting systems
- 2. Pump theory and characteristics, including types of cargo pumps and their safe operation:**
- 3. Tanker safety culture and implementation of safety-management system**
- 4. Monitoring and safety systems, including the emergency shutdown**
- 5. Cargo measurements and calculations**
- 6. Effect of bulk liquid cargoes on trim, stability and structural integrity**
- 7. Oil cargo related operations**
  - .1 Loading and unloading
  - .2 Ballasting and Deballasting
  - .3 Tank cleaning operations
  - .4 Inerting
  - .5 Gas-freeing
  - .6 Ship-to-ship transfers
  - .7 Load on top
  - .8 Crude oil washing
- 8. Cargo-related operation plans, procedures and checklists**
- 9. Calibrate and use monitoring and gas-detection systems, instruments and equipment**
- 10. Manage and supervise personnel with cargo-related responsibilities**

Note: Trainees should have knowledge and understanding of the topics covered in IMO Model Course 1.01 before completing these performance requirements. This knowledge is considered so fundamental for much of the advanced level content within this course that there is merit in reviewing the basic level content quickly before covering the additional elements required at the Advanced level. The learning time has been reduced for many elements on the basis that trainees will be reviewing rather than learning much of this content at this level. It may be necessary for some trainees to refresh their knowledge of basic elements before undertaking this advanced level content.

---

**TOPIC 1      DESIGN AND CHARACTERISTICS OF AN OIL TANKER**

---

<b>Knowledge, Understanding and Proficiency</b>	<b>IMO Reference</b>	<b>Text books Bibliography</b>	<b>Teaching aid</b>
<b>1.0      Knowledge of oil tanker design, systems and equipment, including:</b>	<b>R1,R2, R3,R4</b>	<b>T1,B1,B2</b>	<b>A1,A11, A12,</b>
<b>1.1      General arrangement and construction</b>	<b>R1,R2, R3,R4</b>	<b>T1,B1,B2</b>	<b>A1,A11, A12</b>
1.1.1      Explains the practical application of an oil tanker being divided into fore part, tank area and after part, and the tank area is separated, from fore and after parts, by means of cofferdams			
1.1.2      Explains why accommodation spaces, main cargo control stations and service spaces must be positioned aft of the tank area, but that some exceptions to this rule is possible			
1.1.3      Explains why the navigation bridge may be fitted above the tank area where necessary, but that there must be an open space between the navigation bridge and the cargo tank deck			
1.1.4      Explains why a means must be provided to keep deck spills away from the accommodation			
1.1.5      Explains why entrances, air inlets and openings to accommodation, service spaces and control stations shall not face the cargo area			
1.1.6      Explains why windows and side scuttles facing the cargo area and for some distance away from the cargo area on each side must be of non-opening type			
1.1.7      Describes the special requirements that have been laid down for the fire integrity of bulkheads and decks of oil tankers			
1.1.8      Explains the operational advantages and disadvantages of double hull and mid deck tanker designs			

Knowledge, Understanding and Proficiency	IMO Reference	Text books Bibliography	Teaching aid
1.1.9	Draws the cross section of:		
	- double hull tanker		
	- mid-deck tanker		
1.1.10	Explains the practical implications as a result of revised Annex I of MARPOL as amended, from 2007 the pump-room must have a double bottom protection		
1.1.11	Explains why the capacity and distribution of segregated ballast tanks (SBT) and Clean Ballast tanks (CBT) must be such that:		
	- ballast is sufficient for all but severe weather conditions		
	- at all stages of the voyage, the ship is trimmed by stern with the propeller submerged with defined maximum trim		
1.1.12	Explains how SBT and CBT contribute towards the protection of the marine environment		
1.1.13	Explains the operational advantages and disadvantages of SBT over CBT		
1.1.14	Explains how Crude Oil Washing (COW) contributes towards the protection of the marine environment		
1.1.15	States that oil tankers may have been provided with SBT even if not required to do so, but the capacity need not necessarily comply with the international requirements		
1.1.16	Explains how subdivision and stability requirements for oil tankers are intended to provide survival capability in case of stranding or collision damage		
1.1.17	Explains the practical implications of the requirements with respect to the number and minimum capacity of slop-tanks		
1.1.18	States that Oil tanker requirements apply equally to combination carriers		

<b>Knowledge, Understanding and Proficiency</b>		<b>IMO Reference</b>	<b>Text books Bibliography</b>	<b>Teaching aid</b>
1.1.19	States that there are additional requirements for combination carriers concerning slop-tanks and cargo lines in wing tanks			
1.1.20	States that tankers aged 5 years and over are subject to an enhanced survey programme			
<b>1.2</b>	<b>Pumping arrangement and equipment</b>	<b>R1,R2, R3,R4</b>	<b>T1,B1,B2</b>	<b>A1,A11, A12</b>
1.2.1	Explains the practical implications of the cargo pumping equipment			
1.2.2	Explains why the pumping system adopted will depend on the range of cargoes carried a simple system for a VLCC carrying a single cargo or a complex system for multiple grades carriage.			
1.2.3	Explains why all machinery spaces can be isolated from cargo tanks and slop tanks by cofferdams, cargo pump rooms, oil fuel bunker tanks or ballast tanks.			
1.2.4	Explains why pump-rooms containing pumps and their accessories for ballasting, spaces situated adjacent to cargo tanks and slop tanks, and pumps for oil fuel transfer shall be considered as equivalent to a cargo pump-room, provided that such pump-rooms have the same safety standard as that required for cargo pump-rooms.			
<b>1.3</b>	<b>Tank arrangement, pipeline system and tank venting arrangement</b>	<b>R1,R2, R3,R4</b>	<b>T1,B1,B2</b>	<b>A1,A11, A12</b>
1.3.1	States that the maximum length of an oil tank is governed by MARPOL regulations			
1.3.2	Explains the difference between a free-flow tanker and a pipeline tanker			

---

Knowledge, Understanding and Proficiency	IMO Reference	Text books Bibliography	Teaching aid
1.3.3	Explains the operational advantages and limitations of the free-flow system		
1.3.4		Explains why: <ul style="list-style-type: none"><li>- pipeline systems on board tankers differ in their degree of sophistication, depending on employment of the tanker</li><li>- ULCC and VLCC have relatively simple pipeline system</li><li>- some product/parcel tankers may have very sophisticated pumping and piping system</li></ul>	
1.3.5	Explains the practical implications of MARPOL's requirements for a high overboard line, enabling discharge above the waterline		
1.3.6	Explains how the cargo stripping system is essential to reduce cargo residues in tanks and pipelines		
1.3.7	Explains how the stripping system is used to handle tank draining when tank washing		
1.3.8	Explains how stripping is carried out on tankers that do not have separate stripping systems		
1.3.9	Describes the means of emptying pump lines and discharging the residues via a special small-diameter pipeline on crude-oil tankers.		
1.3.10	Explains the operational advantages and disadvantages of: <ul style="list-style-type: none"><li>- a gate or sluice valve</li><li>- a butterfly valve</li><li>- a globe valve</li><li>- a non-return valve</li><li>- an angle stop valve</li><li>- a ball valve</li></ul>		
1.3.11		Explains why positive displacement pumps are fitted with a relief valve	
1.3.12	Explaining why a non-return valve is fitted on the discharge side of a centrifugal pump		

Knowledge, Understanding and Proficiency	IMO Reference	Text books Bibliography	Teaching aid
1.3.13			
Explains why many deep-well pumps do not have non-return valves			
1.3.14			
Describes the operation of an eductor			
1.3.15			
Explains why an eductor is used			
1.3.16			
Explains how different parcels of cargo may be completely isolated from one another during loading carriage and subsequently during discharge.			
<b>Venting arrangements</b>			
1.3.17			
Explains the practical implications of petroleum gas being expelled from cargo tank vents during many cargo handling and associated operations and the related dangers			
1.3.18			
Lists examples of cargoes and situations which lead to gas evolution and explains how to determine which cargoes exhibit this property			
1.3.19			
Explains gas dispersion and variables affecting gas dispersion			
1.3.20			
Explains why the venting system of cargo tanks is entirely distinct from such systems in other compartments of the ship			
1.3.21			
Explains practical implication of venting arrangements that may be independent for each cargo tank or combined with those for other tanks			
1.3.22			
Explains why the vacuum side of the venting system must be provided with devices to prevent the passage of flame into the cargo tanks			
1.3.23			
Explains why precautions must be taken to guard against liquid rising in the venting system to a height which would exceed the design head of the cargo tanks and how they shall include high-level alarms or overflow control systems, together with gauging devices and tank-filling control procedures			

Knowledge, Understanding and Proficiency	IMO Reference	Text books Bibliography	Teaching aid
1.3.24 Explains why SOLAS requires height of vent openings not be less than 2 meters above the deck and why distances above deck and away from openings are dependent on the fitting of high-velocity vents			
1.3.25 Explains the reason for, and the functioning of PV valves			
1.3.26 Explains, with the aid of a drawing, the functioning of purge pipes			
1.3.27 Explains why the SOLAS amendments require tankers carrying low flashpoint petroleum products or crude oil to have a secondary means of venting			
1.3.28 Explains the secondary means of venting and alternative arrangement of having pressure sensors fitted in each cargo tank			
1.3.29 Explains vapour recovery line construction arrangements as per MARPOL Annex VI			
1.3.30 Explains why Shipboard Vapour Emission Control (VEC) systems tend to fall into two main categories			
<b>1.4 Gauging systems and alarms</b>	<b>R1,R2, R3,R4</b>	<b>T1,B1,B2</b>	<b>A1,A11, A12</b>
1.4.1 Describes, with aid of drawing, the operating principle of: <ul style="list-style-type: none"> <li>- mechanically operated float gauges</li> <li>- electrically powered servo-operated gauges - electrical capacitance gauges - bubbler gauges</li> <li>- pneumatic or hydraulic level gauges using a closed cell</li> <li>- other differential-Pressure-type gauges</li> <li>- ultrasonic and sonic gauge</li> <li>- radioactive gauges</li> <li>- surface-sensing-type-gauges</li> </ul>			

<b>Knowledge, Understanding and Proficiency</b>		<b>IMO Reference</b>	<b>Text books Bibliography</b>	<b>Teaching aid</b>
1.4.2	Describes the terms 'accuracy' and 'repeatability' and the factors influencing both			
1.4.3	Explains why high level alarms shall be independent of the closed level measuring system.			
1.4.4	Explains why two combined level measuring and high level alarm systems may be accepted as equivalent to independent measuring systems			
1.4.5	Explains how generally extensive self-monitoring is incorporated in the system covering all credible faults.			
<b>1.5</b>	<b>Cargo heating systems</b>	<b>R1,R2, R3,R4</b>	<b>T1,B1,B2</b>	<b>A1,A11, A12</b>
1.5.1	Explains why certain cargoes may require heating and how to determine if heating is necessary: -			
1.5.2	Explains how heating coils are used for heating cargo			
1.5.3	Explains the limitations of steel heating coils with regards to the cargoes			
1.5.4	Explains why wing tanks generally require more heat than centre cargo tanks			
1.5.5	Explains why bitumen requires far more heat than other oils and may therefore only be carried in special ships			
1.5.6	Explains why slop-tanks are heated to facilitate the separation of water and oil			
1.5.7	Explains the operational use of "cargo heat exchangers" and "heating coils"			
<b>1.6</b>	<b>Tank cleaning, gas-freeing and inerting systems</b>	<b>R1,R2, R3,R4</b>	<b>T1,B1,B2</b>	<b>A1,A11, A12</b>
1.6.1.	Explains the operational difference between "programmable" and "non-programmable" tank cleaning machines			



Knowledge, Understanding and Proficiency	IMO Reference	Text books Bibliography	Teaching aid
<p>i. Explains the operational difference between portable and fixed tank cleaning machines</p>			
<p>1.6.3 Explains that gas freeing may be carried out by fixed or portable blowers</p>			
<p>1.6.4 Describes the difference between two major types of inert gas generating systems</p> <ul style="list-style-type: none"> <li>- flue gas</li> <li>- independent generators.</li> </ul>			
<p>1.6.5 Explains the design function of the scrubber and the demister</p>			
<p>1.6.6 Explains the type of equipment used to prevent a backflow of gas from the cargo tanks to the generating plant</p>			
<p>1.6.7 Explains what equipment is used to indicate the following malfunctions :</p> <ul style="list-style-type: none"> <li>- a rise in the oxygen content of the gas</li> <li>- a drop in the supply pressure</li> <li>- insufficient cooling and cleaning in the scrubber</li> <li>- backflow of hydrocarbon gas to the generating plant</li> </ul>			
<p>1.6.8 Explains how the construction of the scrubber allows for hot corrosive gases</p>			
<p>1.6.9 Describes the construction design to prevent impairing the drainage of the effluent when the ship is fully loaded</p>			
<p>1.6.10 Describes scrubber instrumentation and alarms such as HLL alarms LL alarms.</p>			
<p>1.6.11 States that at least two blowers are required to be fitted to deliver the scrubbed inert gas to the cargo tanks</p>			
<p>1.6.12 States that in generator systems one blower may be permitted provided sufficient spares are carried</p>			
<p>1.6.13 States that each blower has an inlet valve and a discharge valve</p>			

Knowledge, Understanding and Proficiency	IMO Reference	Text books Bibliography	Teaching aid
1.6.14	States total blower capacity to be 1.25 times maximum discharging rate with all cargo pumps operated simultaneously		
1.6.15	Explains that blowers may also have an air inlet and may therefore also be used to gas - free cargo tanks		
1.6.16	Explains why corrosion - resistant materials or coatings must be used in the construction of blowers and casings		
1.6.17	Explains why fan casings should be fitted with drains		
1.6.18	States that sufficient openings should be provided to permit inspection		
1.6.19	States that failure of the blowers should be indicated by an alarm		
1.6.20	States that a means should be fitted for continuously indicating the temperature and pressure of the inert gas at the discharge side of the blowers		
1.6.21	Explains why the inert gas blowers should shut down automatically in the event of: <ul style="list-style-type: none"><li>- low water pressure or low flow rate in the scrubber</li><li>- high water level in the scrubber</li><li>- high gas temperature</li></ul>		
1.6.22	States that a minimum inert gas pressure of 100 mm water gauge should be maintained in any one cargo tank or combination of cargo tanks		
1.6.23	Describes the two functions of the gas pressure regulating valve		
1.6.24	Explains how the gas pressure regulating valve is automatically controlled		
1.6.25	Sketches and shows different arrangements for controlling the inert gas pressure in the inert gas main, i.e.: <ul style="list-style-type: none"><li>- throttling the regulating valve</li><li>- re- circulating the inert gas to the scrubber</li></ul>		

Knowledge, Understanding and Proficiency	IMO Reference	Text books Bibliography	Teaching aid
1.6.26			
1.6.27			
1.6.28			
1.6.29			
1.6.30			
1.6.31			
1.6.32			
1.6.33			
1.6.34			
1.6.35			
1.6.36			
1.6.37			
1.6.38			

Knowledge, Understanding and Proficiency	IMO Reference	Text books Bibliography	Teaching aid
1.6.39	States that the inert gas piping may also serve as venting piping and , in such cases, the inert gas main leads to the mast riser		
1.6.40	Explains what other venting arrangements are possible		
1.6.41	Explains how the inert gas distribution and venting system must allow for : <ul style="list-style-type: none"><li>- gas freeing</li><li>- purging</li><li>- inerting</li><li>- cargo and ballast handling</li><li>- tank entry</li></ul>		
1.6.42	Describes the functions of the following : <ul style="list-style-type: none"><li>- blanks or valves to isolate tanks</li><li>- vent stacks or vent risers</li><li>- p/v valves</li><li>- liquid - filled p/v breakers</li></ul>		
1.6.43	Describes the construction necessary to allow for dilution and displacement of the atmosphere in tanks		
1.6.44	Explains how double hull spaces of oil tankers are fitted with suitable connections for inert gas supply.		
1.6.45	States that an inerted double hull space reduces corrosion and avoids explosion risk in case of oil leakage from cargo tanks.		
1.6.46	Explains the requirements for a fixed oxygen analyser and what it is used to indicate		
1.6.47	Describes where a sampling point should be provided for use with portable instruments		
1.6.48	States that at least 2 sets of portable instruments must be provided for measuring concentrations of oxygen and flammable vapour		
1.6.49	States that ballast tanks in oil tankers built after 2006, must have provisions to be inerted		

<b>Knowledge, Understanding and Proficiency</b>		<b>IMO Reference</b>	<b>Text books Bibliography</b>	<b>Teaching aid</b>
<b>1.7</b>	<b>Ballast system</b>	<b>R2,R3</b>	<b>T1,B1,B2</b>	<b>A1,A11, A12</b>
1.7.1	Explains why a spool piece is used to connect the ballast system to the cargo system and why it should be clearly identified			
1.7.2	Explains why sea and overboard discharge valves are connected to the cargo and ballast systems			
<b>1.8</b>	<b>Cargo area venting and accommodation ventilation</b>	<b>R1,R2,R3, R4</b>	<b>T1,B1,B2</b>	<b>A1,A11, A12</b>
1.8.1	Explains why and how the design features allow for the engine room and accommodation areas to be isolated from the cargo area.			
<b>1.9</b>	<b>Slop arrangements</b>	<b>R1,R2,R3, R4</b>	<b>T1,B1,B2</b>	<b>A1,A11, A12</b>
1.9.1	States that effective oil/water interface detectors approved by the Administration shall be provided for a rapid and accurate determination of the oil/water interface in slop tanks			
1.9.2	States that the arrangements of the slop tank or combination of slop tanks shall have a capacity necessary to retain the slop generated by tank washings, oil residues and dirty ballast residues			
1.9.3	States that the total capacity of the slop tank or tanks shall be in accordance with MARPOL Annex I			
<b>1.10</b>	<b>Vapour recovery systems</b>	<b>R1,R2,R3, R4</b>	<b>T1,B1,B2</b>	<b>A1,A11, A12, V012</b>
1.10.1	Explains why the use of insulating flanges or an electrically discontinuous length of hose also apply to the vapour recovery systems			
1.10.2	Describes Vapour Emission Control Systems			

<b>Knowledge, Understanding and Proficiency</b>		<b>IMO Reference</b>	<b>Text books Bibliography</b>	<b>Teaching aid</b>
1.10.3	Describes Vapour Pressure Release Control Valve			
1.10.4	Describes the Cargo Pipeline Partial Pressure control system			
1.10.5	Describes Vapour Recovery Systems - Condensation Systems - Absorption Systems - Absorption Carbon Vacuum-Regenerated Adsorption			
<b>1.11</b>	<b>Cargo-related electrical and electronic control system</b>	<b>R1,R2,R3, R4</b>	<b>T1,B1,B2</b>	<b>A1,A11, A12</b>
1.11.1	Explains how the automatic detection systems which consists of electrical or electronic devices detect environmental changes created by fire or by the presence of toxic or combustible gases			
1.11.2	Describes the types and difference between heat sensing fire detectors			
1.11.3	States that some types of individual overfill alarms may be provided with an electronic self-testing capability which monitors the condition of the alarm circuitry and sensor and confirms the instrument set point.			
1.11.4	States that modern developments in gas detection technology have resulted in the introduction of electronic instruments using infra-red sensors that can perform the same function as the tankscope.			
1.11.5	States that electrical and electronic tank level indication is provided in the cargo control room			
1.11.6	Explains why all instrumentation in dangerous areas must be intrinsically safe			

<b>Knowledge, Understanding and Proficiency</b>		<b>IMO Reference</b>	<b>Text books Bibliography</b>	<b>Teaching aid</b>
<b>1.12</b>	<b>Environmental protection equipment, including Oil Discharge Monitoring Equipment (ODME)</b>	<b>R1,R2,R3, R4</b>	<b>T1,B1,B2</b>	<b>A1,A11, A12, V013</b>
1.12.1	Explains why compliance with discharge provisions is further ensured by an oil discharge monitoring and control system			
1.12.2	Describes the system capabilities and regulatory requirements			
1.12.3	Describes the function of starting interlock			
1.12.4	Explains how the effect of malfunctioning of the system is determined			
1.12.5	Describes the different principles involved in measuring oil content such as ultraviolet fluorescence, turbidity measurement, light absorption, gas measurement and infra-red absorption			
1.12.6	Explains, with the aid of drawing, the operating principle of a portable oil/water interface detector			
<b>1.13</b>	<b>Tank coating:</b>	<b>R2</b>	<b>T1,B1,B2</b>	<b>A1,A11, A12</b>
	-			
	- 1.13.1 Explains the need for tank coatings and the advantages or disadvantages of different types -			
1.13.2	Explain about coating resistance to different oil cargoes types			
<b>1.14</b>	<b>Tank temperature and pressure control systems</b>	<b>R1,R2,R3, R4</b>	<b>T1,B1,B2</b>	<b>A1,A11, A12</b>
1.14.1	States the importance of being in compliance with SOLAS requirements and other relevant regulation for tank ullage pressure			
1.14.2	States the typical settings of the P/V breakers			
1.14.3	States that pressure will remain as a constant for a given cargo/liquid temperature and, a cargo temperature			

<b>Knowledge, Understanding and Proficiency</b>		<b>IMO Reference</b>	<b>Text books Bibliography</b>	<b>Teaching aid</b>
	will not vary to the same extent as the vapour temperature due to heating or cooling from external sources			
<b>1.15</b>	<b>Fire-fighting systems</b>	<b>R1,R2,R3, R4, R7</b>	<b>T1,B1,B2</b>	<b>A1,A11, A12</b>
1.15.1	Describes the advantages and disadvantages of various fire-extinguishing agents			
1.15.2	Explains that HALON has been decommissioned under IMO guidelines but is still grandfathered for use of existing vessels built prior to 01/01/1994			
1.15.3	Describes the fire protection and extinguishing systems that are required for protection of cargo tank deck area, cargo tanks and pump-room			
1.15.4	States that some tankers may be exempted from the inert gas requirements owing to the size or age			
<b>TOPIC 2</b>	<b>Knowledge of pump theory and characteristics, including types of cargo pumps and their safe operation</b>			
<b>2.0</b>	<b>Knowledge of pump theory and characteristics, including types of cargo pumps and their safe operation</b>	<b>R2</b>	<b>T1,B1,B2</b>	<b>A1,A11, A12</b>
<b>2.1</b>	<b>Pump theory and characteristics including types of cargo pumps and their safe operations</b>	<b>R2</b>	<b>T1,B1,B2</b>	<b>A1,A11, A12</b>
2.1.1	Describes the theory of pumping operations			
2.1.2	Explains the factors which can influence pump suction			
2.1.3	Explains that the discharge pressure will fluctuate when the liquid boils			
2.1.4	Describes the advantages and disadvantages of different types of pumps used on oil tankers			



Knowledge, Understanding and Proficiency	IMO Reference	Text books Bibliography	Teaching aid
2.1.5 Describes the equipment used for final stripping			
2.1.6 Describes the proper starting and operating procedures and how to avoid backflow			
2.1.7 Explains why the actual discharge rate also depends on static and dynamic backpressure of the shore installation			
2.1.8 Explains how shore installations influence the pumping rate			
2.1.9 Explains the procedure used for pumps running in parallel			
2.1.10 Explains the danger of running two or more pumps in parallel if their characteristics are not exactly the same or if the pumps are running at different speeds			
2.1.11 Explains why a stripping pump must be self-priming			
2.1.12 Explains the different types of prime movers for pumps and their operation and control			
2.1.13 Explains the causes and the dangers of overheating pumps and how to prevent it			
2.1.14 Explains the application of screw pumps on oil tankers			
<b>2.2 Pressure Surge</b>	<b>R2</b>	<b>T1,B1,B2</b>	<b>A1,A11, A12</b>
2.2.1 Explains how a pressure surge occurs and what are the possible consequences			
2.2.2 Explains the three pressure components in liquid being pumped			
2.2.3 States that $2L/a$ is known as the pipeline period and defines L as the length of piping and a as the speed of sound in the liquid			
2.2.5 Explains how the closure of a valve can superimpose an additional pressure on the liquid and the effects			

<b>Knowledge, Understanding and Proficiency</b>		<b>IMO Reference</b>	<b>Text books Bibliography</b>	<b>Teaching aid</b>
2.2.6	Explains measures to prevent pressure surges			
<b>TOPIC 3</b>	<b>PROFICIENCY IN TANKER SAFETY CULTURE AND IMPLEMENTATION OF SAFETY-MANAGEMENT SYSTEM</b>			
<b>3.0</b>	<b>Proficiency in tanker safety culture and implementation of safety-management system</b>	<b>R2,R6</b>	<b>T1,B1,B6, B7</b>	<b>A1,A11, A13,A14, V02</b>
3.1	Describes the importance of ISM Code for oil tankers.			
3.2	Describes how OCIMF's Tanker Management and Self-Assessment (TMSA) programme can help vessel operators assess, measure and improve their management systems.			
3.3	States that TMSA is designed to create opportunities and optimize performance in crucial areas such as safety and environmental excellence.			
3.4	Demonstrates a working knowledge of the elements of the ISM Code and SMS procedures and Code of Safe Working Practices (COSWP) in relationship to cargo operations on oil tankers			
<b>TOPIC 4</b>	<b>KNOWLEDGE AND UNDERSTANDING OF MONITORING AND SAFETY SYSTEMS, INCLUDING THE EMERGENCY SHUTDOWN</b>			
<b>4.0</b>	<b>Knowledge and understanding of monitoring and safety systems, including the emergency shutdown</b>	<b>R1,R2,R4, R6</b>	<b>T1,B1,B2, B4,B5</b>	<b>A1,A4,A5, A6, A7,A8, A11,A13</b>
4.1	Explains the importance of regular atmosphere monitoring			
4.2	Explains the importance of the monitoring tank pressure			

Knowledge, Understanding and Proficiency	IMO Reference	Text books Bibliography	Teaching aid
4.3			
Describes the equipment used to enable closed monitoring of tank contents			
4.4			
Describes the possible danger of H <sub>2</sub> S on electronic instruments.			
4.5			
Explains how ventilation systems should be operated in the presence of toxic or flammable gases			
4.6			
Explains when personnel should carry personal monitors			
4.7			
Explains the operating principles of gas detection equipment			
4.8			
Performs measurement of oxygen, hydrocarbon and toxic gas concentrations			
4.9			
Explains why throughout the discharge of cargo the oxygen content of the inert gas supply must be carefully monitored			
4.10			
Explains how individual Tank Pressure Monitoring and Alarm Systems are checked regularly			
4.11			
Explains the dangers of residual water in the inert gas distribution piping and how it may be avoided			
4.12			
Explains the importance of monitoring a line pressures on oil tankers and what might cause the changes eg vapour lines, inert gas lines, cargo lines, and ballast lines...			
4.13			
Explains the importance of monitoring void and ballast spaces located within the cargo areas			
4.14			
Explains why the external atmosphere should be monitored for hydrocarbon and toxic vapours prior doing any hot work			
4.15			
Explains why enclosed spaces must be monitored prior tank entry for 21% oxygen, (no toxic vapours) not more than 50 % of the occupational exposure limit (OEL) of any toxic			

Knowledge, Understanding and Proficiency	IMO Reference	Text books Bibliography	Teaching aid
vapours and gasses and a reading of less than 1% LFL must be obtained on suitable monitoring equipment			
4.16			
States that SOLAS requires that ships built from July 2002 are provided with continuous monitoring of the pump-room atmosphere and an audible and visual alarm system which will activate when the hydrocarbon gas concentration in the pump-room exceeds a pre-set level, which should not be more than 10% LFL.			
4.17			
Explains why it is important throughout loading, to regularly check all full and empty tanks			
4.18			
Explains why pressure monitoring systems should be continuously monitored by sensors with appropriate alarms			
4.19			
Explains when monitoring of gas concentration level should be at an increased frequency			
4.20			
Explains why atmosphere testing should be undertaken regularly during the gas freeing operation to monitor progress			
4.21			
States that the use of an oil discharge monitoring equipment (ODME) for monitoring the discharge of clean ballast will give an early warning of any undiscovered contaminated ballast caused by, for example, inter-tank leakage when loading and deballasting are being carried out simultaneously			
4.22			
States that the emergency shutdown of cargo pumps, alarms and trips, level alarms, etc., where fitted, should be tested regularly to ensure that they are functioning correctly			

Knowledge, Understanding and Proficiency	IMO Reference	Text books Bibliography	Teaching aid
<b>TOPIC 5    LOADING, UNLOADING, CARE AND HANDLING OF CARGO</b>			
<b>5.0            Loading, unloading,            care and handling of cargo</b>  <i>in case a simulator is provided, training can be done on a simulator (suggested exercises appended in Part D3)</i>	R2	B2	A1,A11, A12,A13
<b>5.1            Ability to perform cargo measurements and calculations</b>	R2	B2	A1,A11, A13
5.1.1        Performs cargo calculation given: -temperature, -trim and lists -soundings or ullage measurements using the ships ullage tables -specific gravity, density, or API gravity -BS&W (Bottom Sediment and Water) Determining the volume as: Cubic meters Barrels (of 42 US gallons) And weight as: Metric tons long tonnes			
5.1.2        Explains the use of the liquid wedge formula			
5.1.3        Performs cargo calculations given the following:			
5.1.3.1      The mass of full cargo to be lifted, given deadweight scales, loading and discharge port limitations, length of voyage, ballast fuel, stores and consumption for multiple load and discharge ports			
5.1.3.2      The volume of cargo that can be lifted, given the relative density or API at 60°F and the cargo temperature			

<b>Knowledge, Understanding and Proficiency</b>		<b>IMO Reference</b>	<b>Text books Bibliography</b>	<b>Teaching aid</b>
5.1.3.3	Whether bending, hogging, and sheering stresses are within acceptable limits, given the load distribution and appropriate graphs			
<b>TOPIC 6</b>	<b>KNOWLEDGE OF THE EFFECT OF BULK LIQUID CARGOES ON TRIM, STABILITY AND STRUCTURAL INTEGRITY</b>			
<b>6.0</b>	<b>Knowledge of the effect of bulk liquid cargoes on trim, stability and structural integrity</b>	<b>R2</b>	<b>B1, B2</b>	<b>A1,A11 A12,A13</b>
<b>6.1</b>	<b>Factors affecting stability calculations</b>	<b>R2</b>	<b>B1, B2</b>	<b>A1,A11 A12,A13</b>
6.1.1	States that some trim and stability manuals only deal with arrival and departure conditions and vessels may not be aware that stability problems may exist during cargo transfers.			
6.1.2	States that approved stability booklet provided on board should be consulted to determine restrictions with regard to maximum trim, forward draft and slack tanks.			
6.1.3	States that the loading and discharging operations shall be completed in such a manner so as ensure that while at sea the vessel complies with the minimum trim criteria mentioned in Annex I of MARPOL as amended.			
6.1.4	States that many ports require that throughout loading and discharging conditions vessel's propeller remains fully immersed at all times and may also have restrictions on maximum trim			
6.1.5	States that it is required to comply with the approved stability booklet for the vessel and endeavour to have minimum slack tanks to prevent sloshing damages.			

<b>Knowledge, Understanding and Proficiency</b>		<b>IMO Reference</b>	<b>Text books Bibliography</b>	<b>Teaching aid</b>
<b>TOPIC 7</b>	<b>KNOWLEDGE AND UNDERSTANDING OF OIL CARGO RELATED OPERATIONS</b>			
<b>7.0</b>	<b>Knowledge and understanding of oil cargo-related operations, including</b>	<b>R1,R2,R3, R4,R6</b>	<b>T1,B1,B2, B3,B4,B5, B7</b>	<b>A1,A11 A12,A13</b>
<b>7.1</b>	<b>Loading and Unloading plans</b>	<b>R1,R2,R3, R4,R6</b>	<b>T1,B1,B2, B3,B4,B5, B7</b>	<b>A1,A11 A12,A13</b>
7.1.1	Explains why the plan should cover all stages of cargo operation and the detailed sequence of cargo and ballast transfer			
7.1.2	Prepares a loading and unloading plan taking into account the ship's stability and all other important factors (see part D) and an emergency shutdown procedure agreed upon between all designated ships and terminal personnel			
7.1.3	Explains the procedure to commence loading and unloading under different conditions			
7.1.4	Explains the danger of line blowing and why the plan should include the precautions to be taken			
<b>7.2</b>	<b>Ballasting and de-ballasting</b>	<b>R1,R2,R3, R4,R6</b>	<b>T1,B1,B2, B3,B4,B5, B7</b>	<b>A1,A11 A12,A13</b>
7.2.1	Explains the considerations affecting ballast quantity and the tanks to be used			
7.2.2	Explains the stages of ballasting and de-ballasting and the associated stresses			
7.2.3	Explains that ballasting operations whilst alongside should be discussed with the terminal prior to commencement			
7.2.4	Explains CBT operations during a normal tanker voyage			

<b>Knowledge, Understanding and Proficiency</b>		<b>IMO Reference</b>	<b>Text books Bibliography</b>	<b>Teaching aid</b>
7.2.5	Explains the purpose of the dedicated clean ballast tank operation manual			
7.2.6	Explains when ballast can be taken into dirty cargo tanks			
7.2.7	Explains why nominated cargo tanks must be crude-oil-washed before ballasting			
7.2.8	States the discharge provisions for oil and oily mixtures such as dirty ballast from the cargo-tank area of all oil tankers should be in accordance with MARPOL Annex I			
7.2.9	Describes the change of ballast at sea in compliance with the discharge requirements			
<b>7.3</b>	<b>Tank cleaning operations</b>	<b>R1,R2,R3, R4, R6</b>	<b>T1,B1,B2, B4,B5</b>	<b>A1,A11 A12,A13</b>
7.3.1	Explains the reason for tank washing operations and how the coating type effects the operations			
7.3.2	Describes tank cleaning with: <ul style="list-style-type: none"> <li>- Cold water</li> <li>- Hot water</li> </ul>			
7.3.3	States that tank cleaning produces large quantities of oil-contaminated water			
7.3.4	States that the volume of oily water may be reduced if tanks have first been crude oil washed			
7.3.5	Describes tank washing operations with portable and fixed machines			
7.3.6	Describes how to control the movements of single- and multiple-nozzle machines			
7.3.7	Explains the dangers that can occur when tank washing stirs up oily residues within a tank			
7.3.8	Explains why tank washing also causes electrostatic hazards as a result of water mist, water slugs and introduction into the tanks of portable tank-washing machines and explains which measures to take			



Knowledge, Understanding and Proficiency	IMO Reference	Text books Bibliography	Teaching aid
7.3.9 Explains the precautions to be taken when tanks must be washed in non-inerted atmosphere			
<b>7.4 Inerting</b>	<b>R1,R2,R3, R4, R6</b>	<b>T1,B1,B2, B4,B5, B7</b>	<b>A1,A11 A12,A13</b>
7.4.4 States that "purging" means replacement of hydrocarbon vapours with inert gas			
7.4.5 Explains, with the aid of a flammability diagram, how purging will prevent a flammable atmosphere developing within a tank and prevent primary and secondary explosions			
7.4.6 States that the tank pressure must be kept under positive IG pressure to prevent the ingress of air			
7.4.7 Explains what equipment is used to indicate the following malfunctions <ul style="list-style-type: none"> <li>- a rise in the oxygen content of the gas</li> <li>- a drop in the supply pressure</li> <li>- insufficient cooling and cleaning in the scrubber</li> </ul> backflow of hydrocarbon gas to the generating plant			
7.4.8 States that there could be a loss of inert gas pressure between blower and cargo tanks due to loss of pressure in cargo tanks.			
7.4.9 Explains why the liquid level and the specific gravity in the breaker are important			
7.4.10 Describes methods to prevent freezing of the liquid - filled p/v breaker			
7.4.11 Describes procedures and reasons for inerting ballast tanks.			
7.4.12 Explains the type of equipment used to prevent a backflow of gas from the cargo tanks to the generating plant			

<b>Knowledge, Understanding and Proficiency</b>		<b>IMO Reference</b>	<b>Text books Bibliography</b>	<b>Teaching aid</b>
<b>7.5</b>	<b>Gas freeing</b>	<b>R1,R2,R3, R4, R6</b>	<b>T1,B1,B2, B4,B5, B7</b>	<b>A1,A11 A12,A13</b>
7.5.1	Explains why the flammability diagram is essential for safe gas-freeing operations			
7.5.2	Explains the operational considerations if gas-freeing is done by portable fans or fixed ventilating systems			
7.5.3	Explains how the IGS is used for purging or for gas-freeing			
7.5.4	Describes both displacement and dilution methods			
<b>7.6</b>	<b>Ship to ship transfers</b>	<b>R1,R2,R3, R4, R6</b>	<b>T1,B1,B2, B3,B4,B5, B7</b>	<b>A1,A11 A12,A13</b>
7.6.1	Explains how the STS operation is carried out at anchor or underway.			
7.6.2	Describes the proper STS equipment to be present on both the vessels			
7.6.3	Explains why proper attention needs to be paid to the difference in freeboard and listing of both vessels while transferring cargo.			
7.6.4	Explains how proper communication should be established between the ships			
7.6.5	States that fire- fighting and oil spill equipment to be present and crew to be well trained to use them in emergency			
7.6.6	States that all guidelines to be followed as per MEPC 59, MARPOL Annex I, SOPEP, SMPEP, STS transfer guide and operational plan			
7.6.7	States that the guidelines of the STS plan should be in accordance with the requirements of IMO "Manual on oil pollution prevention, amended section 1", ICS and OCIMF "ship to ship transfer guide			

Knowledge, Understanding and Proficiency	IMO Reference	Text books Bibliography	Teaching aid
7.6.8 States that any oil tanker operating in the territorial waters or exclusive economic zone of a party to MARPOL, must notify the relevant coastal authority 48 hours prior to the commencement of the STS operation			
<b>7.7 Load on top</b>	<b>R1,R2,R3, R4, R6</b>	<b>T1,B1,B2, B4,B5, B7</b>	<b>A1,A11 A12,A13</b>
7.7.1 Describes decanting and that decanting operations come under the MARPOL discharge requirements			
7.7.2 Explains the benefits of heating the slop-tanks			
7.7.3 Explains "LOT" and rise in level in slop tanks			
7.7.4 Explains why, if LOT procedures have been properly executed, the slop-tank should contain oil, emulsion and some water upon arrival in the loading port			
7.7.5 States that effective LOT procedures depend on determination of the oil/water interface in slop-tanks and other factors			
<b>7.8 Crude Oil Washing</b>	<b>R1,R2,R3, R4, R6</b>	<b>T1,B1,B2, B4,B5, B7</b>	<b>A1,A11 A12,A13</b>
7.8.1 Explains the reasons for and the benefits of COW			
7.8.2 Describes the causes of possible explosion hazards during COW			
7.8.3 States that some crude oils are unsuitable for COW			
7.8.4 States that tanks which have been crude oil washed require additional water rinsing before taking in clean ballast			
7.8.5 States that a description of the COW system on board and of the correct operation of the system is contained in an approved COW Operations			

Knowledge, Understanding and Proficiency	IMO Reference	Text books Bibliography	Teaching aid
7.8.6			
7.8.7			
7.8.8			
7.8.9			
<b>TOPIC 8 DEVELOPMENT AND APPLICATION OF CARGO-RELATED OPERATION PLANS, PROCEDURES AND CHECKLISTS</b>			
<b>8.0 Development and application of cargo related plans, procedures and check lists.</b>	<b>R2</b>	<b>T1,B1,B2, B7</b>	<b>A1,A11 A12,A13, A14</b>
8.1			
8.2			
8.3			
8.4			
8.5			
8.6			

Knowledge, Understanding and Proficiency	IMO Reference	Text books Bibliography	Teaching aid
<b>TOPIC 9 ABILITY TO CALIBRATE AND USE MONITORING AND GAS-DETECTION SYSTEMS, INSTRUMENTS AND EQUIPMENT</b>			
<b>9.0 Ability to calibrate and use monitoring and gas-detection systems, instruments and equipment</b>	R2,R4,R6	B1,B2	A4,A5,A6, A7, A8, A11
9.1 Demonstrates correct instrument-check and calibration procedures and gas measurements			
<b>TOPIC 10 ABILITY TO MANAGE AND SUPERVISE PERSONNEL WITH CARGO-RELATED RESPONSIBILITIES</b>			
<b>10.0 Ability to manage and supervise personnel with cargo-related responsibilities</b>	R2,R6	T1, B1,B2 B3,B4,B6	A1, A11 A13
10.1 Explains the responsible cargo officer on watch supervises and directs the cargo operations ensuring that the stresses and stability of the vessel are always within limits, and that sufficient qualified personnel are on duty			
10.2 Explains how the responsible officer ensures and maintains: <ul style="list-style-type: none"> <li>- suitability of cargo containment prior loading.</li> <li>- Cargo is loaded, as per stowage plan</li> <li>- Cargo is cared for during passage with respect to monitoring its parameters, ventilation, cooling, heating etc., as required.</li> <li>- Cargo is unloaded safely as per plan. Issuing relevant standing/night orders.</li>   <li>- Records for cargo and ballast</li> </ul>			

---

<b>Knowledge, Understanding and Proficiency</b>	<b>IMO Reference</b>	<b>Text books Bibliography</b>	<b>Teaching aid</b>
---	--------------------------	------------------------------------	-------------------------

---

- operations are maintained as per company procedures.
- Records of cargo parameters, soundings of ballast tank and other spaces are maintained as per company procedures.
- Standard language is employed
- seafarers on cargo watches shall carry out the work as assigned to them by the responsible officer of the watch

---

**COMPETENCE 2      Familiarity with physical and chemical properties of oil cargoes**

---

TRAINING OUTCOMES:

Demonstrates a knowledge and understanding of:

**Properties of oil cargoes;**

- .1 physical properties
- .2 chemical properties
- .3 understanding the information contained in a Safety Data Sheet (SDS)

Note: Trainees should have knowledge and understanding of the topics covered in IMO Model Course 1.01 before completing these performance requirements. This knowledge is considered so fundamental for much of the advanced level content within this course that there is merit in reviewing the basic level content quickly before covering the additional elements required at the Advanced level. The learning time has been reduced for many elements on the basis that trainees will be reviewing rather than learning much of this content at this level. It may be necessary for some trainees to refresh their knowledge of basic elements before undertaking this advanced level content

<b>TOPIC 11 PHYSICAL AND CHEMICAL PROPERTIES OF OIL CARGOES</b>				
<b>Knowledge, Understanding and Proficiency</b>		<b>IMO Reference</b>	<b>Text books Bibliography</b>	<b>Teaching aid</b>
<b>11.0</b>	<b>Knowledge and understanding of the physical and chemical properties of oil cargoes</b>	<b>R2</b>	<b>B2</b>	<b>A1,A11, A13</b>
<b>11.1</b>	<b>Physical properties</b>	<b>R2</b>	<b>B2</b>	<b>A1,A11, A13</b>
11.1.1	Explains operational significance of melting, sublimation, evaporation, melting point and boiling point, surface tension, adhesion, cohesion, hydrostatic pressure, miscibility, solubility and diffusion as these terms apply to liquids			
11.1.2	Explains how volatility relates to vapour pressure			
11.1.3	Explains how cargoes are classified on the basis of vapour pressure and flashpoint			
11.1.4	Explains electrostatic accumulation and how to determine which products are considered static accumulators			
<b>11.2</b>	<b>Chemical properties</b>	<b>R2</b>	<b>B2</b>	<b>A1,A11, A13</b>
11.2.1	Explains the difference between 'light' and 'heavy' in practical significance			
	11.2.2 Explains the difference between "sweet and sour" crude oil and the practical significance			
	11.2.3 Explains that many oil products have chemical properties that may pose a hazard that needs to be taken into consideration			
<b>11.3</b>	<b>Understanding the information contained in a Safety Data Sheet (SDS)</b>	<b>R2,R6</b>	<b>T1,B1,B2</b>	<b>A1,A11, A13</b>
11.3.1	Explains and demonstrates the operational use of the SDS			



---

**COMPETENCE 3 Take precautions to prevent Hazards**

---

TRAINING OUTCOMES:

Demonstrates a knowledge and understanding of:

**Hazards and control measures associated with oil tanker cargo operations**

- .1 toxicity
- .2 flammability and explosion
- .3 health hazards
- .4 inert gas composition
- .5 electrostatic hazards
- .6 oxygen deficiency
- .7 dangers of non-compliance with relevant rules/regulations

Note: Trainees should have knowledge and understanding of the topics covered in IMO Model Course 1.01 before completing these performance requirements. This knowledge is considered so fundamental for much of the advanced level content within this course that there is merit in reviewing the basic level content quickly before covering the additional elements required at the Advanced level. The learning time has been reduced for many elements on the basis that trainees will be reviewing rather than learning much of this content at this level. It may be necessary for some trainees to refresh their knowledge of basic elements before undertaking this advanced level content

---

**TOPIC 12 HAZARDS AND THEIR CONTROL MEASURES**

---

Knowledge, Understanding and Proficiency	IMO Reference	Text books Bibliography	Teaching aid
12.0 Knowledge and understanding of the hazards and control measures associated with oil tanker cargo operations, including:	R2	B1,B2	A1,A2,A3, A4,A5,A6, A7,A8,A9 A10,A11, A13
12.1 Toxicity	R2	B1,B2	A1,A2,A3, A4,A5,A6, A7,A8,A9 A10,A11, A13
12.1.1 States that the toxicity of a substance is difficult to measure and that it is therefore rated on the basis of studies performed by way of LD <sub>50</sub> and LC <sub>50</sub> tests performed on animals and extrapolated for the human body			

---

**TOPIC 12 HAZARDS AND THEIR CONTROL MEASURES**

---

<b>Knowledge, Understanding and Proficiency</b>		<b>IMO Reference</b>	<b>Text books Bibliography</b>	<b>Teaching aid</b>
12.1.2	Explains how toxicity hazards can be controlled			
<b>12.2</b>	<b>Flammability and explosion</b>	<b>R2</b>	<b>B1,B2</b>	<b>A1,A2,A3, A4,A5,A6, A7,A8,A9 A10,A11, A13</b>
12.2.1	Defines flashpoint and explains how to assess and control related operational hazard			
12.2.2	Explains the operational consequences of hydrocarbon gas not be evenly distributed within a space			
12.2.3	Sketch a flammability diagram and with the aid of the diagram describes the effects on flammability of tank atmosphere during: <ul style="list-style-type: none"> <li>- Gas-freeing</li> <li>- Purging</li> <li>- Purging and gas-freeing of cargo tanks</li> </ul>			
12.2.4	Explains sources of ignition and how to control them: <ul style="list-style-type: none"> <li>- Smoking</li> <li>- Hot work</li> <li>- Frictional Sparks</li> <li>- Electrical Sparks</li> <li>- Chemical Sparks</li> <li>- Static Electricity</li> <li>- Auto ignition Temperatures</li> <li>- Spontaneous combustion</li> <li>- Pyrophores</li> <li>- Polar solvents</li> <li>- Non –intrinsically safe equipment</li> </ul>			
12.2.5	Explains the dangers of gas dispersion for the ship's accommodation and terminal jetties			

---

**TOPIC 12 HAZARDS AND THEIR CONTROL MEASURES**

---

<b>Knowledge, Understanding and Proficiency</b>		<b>IMO Reference</b>	<b>Text books Bibliography</b>	<b>Teaching aid</b>
12.2.6	Explains dispersion control measures			
<b>12.3</b>	<b>Health hazards</b>	<b>R2</b>	<b>B1,B2</b>	<b>A1,A2,A3, A4,A5,A6, A7,A8,A9 A10,A11, A13</b>
12.3.1	Describes the effects of exposure to petroleum liquids and vapours and explains how to prevent it			
12.3.2	Explains the difference between acute and chronic exposure and poisoning			
12.3.3	Lists typical toxic constituents of petroleum gas			
12.3.4	Explains the operational methods to prevent exposure to concentrations above TLV - TWA STEL and Ceiling limits			
12.3.5	Explains why:			
12.3.5.1	The absence of a smell of gas is insufficient guarantee of its absence			
12.3.5.2	A combustible gas indicator cannot be expected to measure TLV			
12.3.6	States that it is required to ensure all external doors and ports in the accommodation are closed when cargo area venting is carried out			
12.3.7	States that if there is a wind, eddies can be created on the lee side of a tanker's accommodation or deck structure which can carry vented gas towards the structure.			
12.3.8	States that a positive pressure must be maintained inside the accommodation, and air conditioning intakes, which may permit the entry of cargo vapours, must be closed.			
12.3.9	States that engine room vents may be left open. However, consideration should be given to			

---

**TOPIC 12 HAZARDS AND THEIR CONTROL MEASURES**

---

<b>Knowledge, Understanding and Proficiency</b>	<b>IMO Reference</b>	<b>Text books Bibliography</b>	<b>Teaching aid</b>
<p>closing them where such action would not adversely affect the safe and efficient operation of the engine room spaces served</p>			
<p>12.3.10 Explains the reasons for a lower oxygen content in enclosed spaces</p>			
<p>12.3.11 Describes the symptoms that appear when the oxygen content decreases.</p>			
<p>12.3.12 Explains the importance of monitoring oxygen content and the control measures to prevent exposure to low levels</p>			
<p><b>12.4 Inert Gas Composition</b></p>	<p><b>R2,R4</b></p>	<p><b>B1,B2</b></p>	<p><b>A1,A2,A3, A4,A5,A6, A7,A8,A9 A10,A11, A13</b></p>
<p>12.4.1 Explains the hazards associated with inert gas and how to control them</p>			
<p><b>12.5 Electrostatic hazards</b></p>	<p><b>R2</b></p>	<p><b>B1,B2</b></p>	<p><b>A1,A2,A3, A4,A5,A6, A7,A8,A9 A10,A11, A13</b></p>
<p>12.5.1 Explains what charge separation is, when it occurs and how to control it</p>			
<p>12.5.2 Explains the process of charge relaxation and factors relevant to relaxation</p>			
<p>12.5.3 Explains in which tanker operations high electrostatic field strength may develop the consequences and the means of control</p>			
<p>12.5.4 Explains why single-electrode discharges are unlikely to lead to explosions on tankers</p>			
<p>12.5.5 Gives examples of two-electrode discharges and describes when these discharges may cause ignition</p>			

---

**TOPIC 12 HAZARDS AND THEIR CONTROL MEASURES**

---

<b>Knowledge, Understanding and Proficiency</b>	<b>IMO Reference</b>	<b>Text books Bibliography</b>	<b>Teaching aid</b>
12.5.6 Explains how to prevent the instantaneous release of energy with respect to: - Conductors - Liquid non-conductors - Solid non-conductors - Intermediate liquid & solid non-conductors			
12.5.7 Explains the function of anti-static additives			
12.5.8 Explains the electrostatic hazards of equipment permanently mounted in the upper part of a tank, and the measures to minimize the hazards			
12.5.9 Explains how operations can cause a charged mist to develop within a tank			
12.5.10 Explains the dangers of introducing inert gas or carbon dioxide into a charged atmosphere			
12.5.11 Explains the electrostatic hazards associated with synthetics i.e. clothing and lines			
12.5.12 Explains the operational requirements for electrical bonding			
<b>12.6 Knowledge and understanding of dangers of non-compliance with relevant rules/regulations</b>	<b>R2,R3</b>	<b>B1,B2</b>	<b>A1,A2,A3, A4,A5,A6, A7,A8,A9 A10,A11, A13</b>
12.6.1 Explains the direct repercussions on the safety of vessels, the well-being of crews and on the environment for non-compliance with regulations regarding the above hazards			

---

**COMPETENCE 4      Apply occupational health and safety precautions**

---

TRAINING OUTCOMES:

Demonstrates a knowledge and understanding of:

**Safe working practices, including risk assessment and personal shipboard safety relevant to oil tankers**

- .1 precautions to be taken when entering enclosed spaces, including correct use of different types of breathing apparatus.
- .2 precautions to be taken before and during repairs and maintenance work
- .3 precautions for hot and cold work
- .4 precautions for electrical safety
- .5 use of appropriate personal protective equipment.(PPE)

Note: Trainees should have knowledge and understanding of the topics covered in IMO Model Course 1.01 before completing these performance requirements. This knowledge is considered so fundamental for much of the advanced level content within this course that there is merit in reviewing the basic level content quickly before covering the additional elements required at the Advanced level. The learning time has been reduced for many elements on the basis that trainees will be reviewing rather than learning much of this content at this level. It may be necessary for some trainees to refresh their knowledge of basic elements before undertaking this advanced level content.

---

**TOPIC 13                    SAFE WORKING PRACTICES INCLUDING RISK ASSESSMENT**

---

<b>Knowledge, Understanding and Proficiency</b>	<b>IMO Reference</b>	<b>Text books Bibliography</b>	<b>Teaching aid</b>
<b>13.0                    Knowledge and understanding of safe working practices, including risk assessment and personal shipboard safety relevant to oil tankers:</b>	<b>R1,R2,R3, R4, R6</b>	<b>T1,B1,B2, B4,B5,B6,B7</b>	<b>A1,A2,A3, A4,A5,A6, A7,A8,A9, A11,A13</b>
<b>13.1                    Precautions to be taken when entering enclosed spaces, including correct use of different types of breathing apparatus</b>	<b>R1,R2,R3, R4, R6</b>	<b>T1,B1,B2, B4,B5,B6,B7</b>	<b>A1,A2,A3, A4,A5,A6, A7,A8,A9, A11,A13</b>
13.1.1                    Explains that the ship's SMS requires special procedures to be followed if entering an enclosed space (Please see Part D of this course)			
13.1.2                    Demonstrates the procedures required to conduct a risk assessment prior to entry into an enclosed space			
13.1.3                    Explains the benefits and limitations of employing an Entry Permit System (checklist)			
13.1.4                    Explains measures to minimize pump-room hazards			
13.1.5                    Demonstrates the use of the SCBA and positive pressure breathing apparatus and resuscitation equipment			
13.1.6                    Demonstrates the safeguards for enclosed space entry in accordance with industry standards and legal requirements			

Knowledge, Understanding and Proficiency	IMO Reference	Text books Bibliography	Teaching aid
<b>13.2</b> <b>Precautions to be taken before and during repair and maintenance work</b>	<b>R1,R2,R3, R4, R6</b>	<b>T1,B1,B2, B4,B5,B6, B7</b>	<b>A1,A2,A3, A4,A5,A6, A7,A8,A9, A11,A13</b>
13.2.1                    Demonstrates the safeguards before and during repair and maintenance work in accordance with industry standards and legal requirements			
13.2.2                    - Describes the benefits and limitations of the permit to work system i.e. : - enclosed space entry - Cold work - Hot Work. - Electrical isolation. - Working aloft - Working on pressurized vessel - Working over the side (outboard) - Other hazardous tasks			
13.2.3                    Explains the practical benefits of appropriate drills prior to commencing repair work			
13.2.4                    Explains who coordinates the permit and certification processes associated with the repair period			
13.2.5                    Explains the parameters that must be met before declaring a space safe for work			



Knowledge, Understanding and Proficiency	IMO Reference	Text books Bibliography	Teaching aid
<b>13.3</b> <b>Precautions for hot and cold work</b>	<b>R1,R2,R3, R4, R6</b>	<b>T1,B1,B2, B4,B5,B6, B7</b>	<b>A1,A2,A3, A4,A5,A6, A7,A8,A9, A11,A13</b>
13.3.1                    Demonstrates the safeguards before and during hot or cold work in accordance with industry standards and legal requirements			
13.3.2                    Demonstrates the procedures required to conduct a risk assessment prior to hot or cold work			
13.3.3                    Explains how hot work is to be strictly controlled and governed strictly by vessel's SMS procedure			
13.3.4                    States that "designated space" in ER for carrying out hot work are stated and that it should be assessed for risks and the conditions under which hot work could be carried out in such space and that first preference should be given for carrying out hot work in the designated space in ER			
13.3.5                    Explains the parameters that must be met before declaring a space safe for hot or cold work			
<b>13.4</b> <b>Precautions for electrical safety</b>	<b>R1,R2, R4, R6</b>	<b>T1,B1,B2</b>	<b>A1,A2,A3, A4,A5,A6, A7,A8,A9, A11,A13</b>
13.4.1                    Demonstrates the safeguards for electrical safety in accordance with industry standards and legal requirements			
13.4.2                    Demonstrates the procedures required to conduct a risk assessment for electrical safety			

Knowledge, Understanding and Proficiency	IMO Reference	Text books Bibliography	Teaching aid
13.4.3	Explains how electrical safety is to be strictly controlled and governed strictly by vessel's SMS procedure		
13.4.4	Explains the parameters that must be met before electrical safety can be declared		
13.4.5	Explains the consequences of incorrect maintenance procedures regarding explosion-proof or intrinsically safe electrical equipment.		
13.5	<b>Use of appropriate Personal Protective Equipment (PPE)</b>	R1,R2,	T1,B1,B2, B6,
13.5.1	Explains the industry standards and legal requirements for the use of personal protective equipment		A1,A2,A3, A4,A5,A6, A7,A8,A9, A11,A13

---

## COMPETENCE 5 Respond to emergencies

---

### TRAINING OUTCOMES:

Demonstrates a knowledge and understanding of:

- 1 **Oil tanker emergency procedures**
  - .1 ship emergency response plan
  - .2 cargo operations emergency shut down
  - .3 actions to be taken in the event of failure of systems or services essential to cargo
  - .4 firefighting on oil tankers
  - .5 enclosed space rescue
  - .6 use of material safety data sheet (MSDS)
- 2 **Actions to be taken following collision, grounding, or spillage**
- 3 **Medical first aid procedures on board oil tankers**

Note: Trainees should have knowledge and understanding of the topics covered in IMO Model Course 1.01 before completing these performance requirements. This knowledge is considered so fundamental for much of the advanced level content within this course that there is merit in reviewing the basic level content quickly before covering the additional elements required at the Advanced level. The learning time has been reduced for many elements on the basis that trainees will be reviewing rather than learning much of this content at this level. It may be necessary for some trainees to refresh their knowledge of basic elements before undertaking this advanced level content

---

**TOPIC 14      EMERGENCY PROCEDURES**

---

<b>Knowledge, Understanding and Proficiency</b>	<b>IMO Reference</b>	<b>Text books Bibliography</b>	<b>Teaching aid</b>
<b>14.0      Knowledge and understanding of oil tanker emergency procedures.</b>	<b>R2,R5, R6</b>	<b>T1,B1,B2, B4,B5,B6,</b>	<b>A1,A11, A13</b>
<b>14.1      Ship emergency response plan</b>			
14.1.1      Explains which oil tankers must have standard emergency response plans for dealing successfully with emergencies arising from oil spillages, fires, explosions, personnel affected by petroleum and other calamities etc.			
14.1.2      Describes the content of standard emergency response plans and how the plan is used to make appropriate decisions			
<b>14.2      Cargo operations emergency shutdown</b>	<b>R2,R5, R6</b>	<b>T1,B1,B2, B4,B5,B6,</b>	<b>A1,A11, A13</b>
14.2.1      Explains that an emergency shutdown procedure should be agreed between ship and shore and explains the possible dangers			
<b>14.3      Actions to be taken in the event of failure of systems or services essential to cargo</b>	<b>R2,R5, R6</b>	<b>T1,B1,B2, B4,B5,B6,</b>	<b>A1,A11, A13</b>
14.3.1      Describes action to be taken on failure of the Inert Gas System			

Knowledge, Understanding and Proficiency	IMO Reference	Text books Bibliography	Teaching aid
14.3.2 Explains what action is to be taken in the event of machinery, pump, valve or equipment failure or emergency to secure the machinery and the tanker and maintain the safety of the tanker and persons involved			
<b>14.4 Fire-fighting on oil tankers</b>	<b>R2,R5, R6</b>	<b>T1,B1,B2, B4,B5,B6,</b>	<b>A1,A11, A13,A14</b>
14.4.1 Describes how firefighting procedures are carried out in accordance to the SMS			
<b>14.5 Enclosed space rescue</b>	<b>R2,R5, R6</b>	<b>T1,B1,B2, B4,B5,B6,</b>	<b>A1,A11, A13</b>
14.5.1 Demonstrates an enclosed space rescue with all relevant rescue equipment.			
<b>14.6 Use of a Safety Data Sheet (SDS)</b>	<b>R2,R5, R6</b>	<b>T1,B1,B2, B4,B5,B6,</b>	<b>A1,A11, A13</b>
14.6.1 Explains with the aid of an MSDS the constituents of the product by chemical name, name in common usage, UN number and the maximum concentration of any toxic components, expressed as a percentage by volume or as ppm.			

Knowledge, Understanding and Proficiency		IMO Reference	Text books Bibliography	Teaching aid
<b>TOPIC 15</b>	<b>ACTIONS TO BE TAKEN FOLLOWING COLLISION, GROUNDING, OR SPILLAGE</b>			
<b>15.0</b>	<b>Actions to be taken following collision, grounding, or spillage</b>	<b>R2,R5, R6</b>	<b>T1,B1,B2, B4,B5,B6,</b>	<b>A1,A11, A13</b>
15.1	Explains standard initial and follow up actions to be taken subsequent to a collision, a grounding or a spillage and activation of the SOPEP			
15.2	Explains the importance of evidence collecting and emergency reporting requirements (see fig 15.6 Part D)			

<b>Knowledge, Understanding and Proficiency</b>		<b>IMO Reference</b>	<b>Text books Bibliography</b>	<b>Teaching aid</b>
<b>TOPIC</b>	<b>KNOWLEDGE OF MEDICAL FIRST AID PROCEDURES ON BOARD OIL TANKERS</b>			
<b>16</b>				
<b>16.0</b>	<b>Knowledge of medical first aid procedures on board oil tankers</b>	<b>R2,R5, R6</b>	<b>T1,B1,B2, B4,B5,B6,</b>	<b>A1,A11, A13</b>
16.1	Explains the actions taken in a medical emergency and how they conform to current recognized first aid practice and international guidelines			

---

**COMPETENCE 6 Take precautions to prevent pollution of the environment**

---

TRAINING OUTCOMES:

Demonstrates a knowledge and understanding to:

**Prevent pollution of the atmosphere and the environment**

Note: Trainees should have knowledge and understanding of the topics covered in IMO Model Course 1.01 before completing these performance requirements. This knowledge is considered so fundamental for much of the advanced level content within this course that there is merit in reviewing the basic level content quickly before covering the additional elements required at the Advanced level. The learning time has been reduced for many elements on the basis that trainees will be reviewing rather than learning much of this content at this level. It may be necessary for some trainees to refresh their knowledge of basic elements before undertaking this advanced level content

---

**TOPIC 17 UNDERSTANDING OF PROCEDURES TO PREVENT POLLUTION OF THE ATMOSPHERE AND THE ENVIRONMENT**

---

Knowledge, Proficiency	Understanding	and	IMO Reference	Text books Bibliography	Teaching aid
17.0	<b>Understanding of procedures to prevent pollution of the atmosphere and the environment</b>		R1,R2, R3,R6	T1,B1,B2, B5	A1,A10, A11,A13
17.1	States that any failure or malfunctioning of the equipment (ODME) must be recorded in the oil record book				
17.2	<b>Controlled operational pollution at sea</b>		R1,R2, R3,R6	T1,B1,B2, B5	A1,A10, A11,A13
17.2.1	17.2.1 Describes how operations are conducted in accordance with accepted principles and procedures to prevent pollution of the environment				



---

## **COMPETENCE 7 Monitor and control, compliance with legislative requirements**

---

### TRAINING OUTCOMES:

Demonstrates a knowledge and understanding of:

Relevant provisions of the international convention for the prevention of pollution from ships (MARPOL), as amended, and other relevant IMO instruments, industry guidelines and port regulations as commonly applied.

Note: Trainees should have knowledge and understanding of the topics covered in IMO Model Course 1.01 before completing these performance requirements. This knowledge is considered so fundamental for much of the advanced level content within this course that there is merit in reviewing the basic level content quickly before covering the additional elements required at the Advanced level. The learning time has been reduced for many elements on the basis that trainees will be reviewing rather than learning much of this content at this level. It may be necessary for some trainees to refresh their knowledge of basic elements before undertaking this advanced level content

---

**TOPIC 18 PROVISIONS OF MARPOL, IMO INSTRUMENTS, INDUSTRY GUIDELINES AND PORT REGULATIONS**

---

<b>Knowledge, Understanding and Proficiency</b>	<b>IMO Reference</b>	<b>Text books Bibliography</b>	<b>Teaching aid</b>
<b>18.0 Knowledge and understanding of relevant provisions of the International Convention for the Prevention of Pollution from Ships (MARPOL), as amended, and other relevant IMO instruments, industry guidelines and port regulations as commonly applied</b>	<b>R1,R2,R3, R6</b>	<b>T1,B1, B2,B5, B6,B7</b>	<b>A1,A11, A12,A13</b>
18.1 Demonstrates a working knowledge of MARPOL Annex I and the procedures to properly monitor and control compliance			
18.2 Demonstrates the ability to correctly complete Oil Record Book entries.			
18.3 States that an international standard for the safe management and operation of ships and for pollution prevention requires an ISM system to be implemented and audited.			

## Part D: Instructor Manual

### ■ Introduction

The instructor's manual provides guidance on the material that is to be presented during the course. The course material reflects the mandatory minimum requirements for the training and qualifications of Masters, Chief Engineer Officers, chief mates, second engineer officers and any person with immediate responsibility for loading, unloading and care during transit and handling, tank cleaning or other cargo related operations on Oil tankers as specified in Regulation V/1-1 paragraph 3 of the International Convention on Standards of Training, Certification and Watch keeping for Seafarers, as amended.

The competences stipulated in the STCW 2010 table A-V/1-1-2 have been broadly divided into the following topics and are reflecting how the trainers should design and conduct their course. This is for guidance only.

To show consistency and adherence to STCW as amended, as given in STCW Code Chapter V, Table A-V/1-1-2, a mapping is provided for easy reference in Part A of this Model course from STCW's competences and training outcomes to the topics covered in this IMO Model course

1. Knowledge of oil tanker design, systems and equipment\*
2. Knowledge of pump theory and characteristics, including types of cargo pumps and their safe operation
3. Proficiency in tanker safety culture and implementation of safety-management system
4. Knowledge and understanding of monitoring and safety systems, including the emergency shutdown
5. Ability to perform cargo measurements and calculations
6. Knowledge of the effect of bulk liquid cargoes on trim, stability and structural integrity
7. Knowledge and understanding of oil cargo related operations
8. Development and application of cargo-related operation plans, procedures and checklists\*
9. Ability to calibrate and use monitoring and gas-detection systems, instruments and equipment
10. Ability to manage and supervise personnel with cargo-related responsibilities
11. Knowledge and understanding of the physical and chemical properties of oil cargoes
12. Knowledge and understanding of the hazards and control measures associated with oil tanker cargo operations
13. Knowledge and understanding of safe working practices, including risk assessment and personal shipboard safety relevant to oil tankers
14. Knowledge and understanding of oil tanker emergency procedures
15. Actions to be taken following collision, grounding, or spillage
16. Knowledge of medical first aid procedures on board oil tankers
17. Understanding of procedures to prevent pollution of the atmosphere and the environment

18. Knowledge and understanding of relevant provisions of the International Convention for the Prevention of Pollution from Ships (MARPOL), as amended, and other relevant IMO instruments, industry guidelines and port regulations as commonly applied.

The texts used as references throughout the course are mentioned in Part A, Course framework are; Teaching Aids (A), IMO Reference Books (R), Text books (T), Bibliography (B) and Videos (V).

The course outline, timetable and lesson plan provide guidance on the time allocations for the course material, but the instructor is free to make adjustments as deemed necessary. The detailed teaching syllabus must be studied carefully. Lesson plans or lecture notes compiled where appropriate.

Some sketches and diagrams are provided at the end of the guidance notes. These will provide examples of the kind of material, which is useful in supporting the presentation of the course.

Throughout the course it is important to stress that, aboard ships rules and regulations must be strictly observed and all precautions taken to maximize safety and minimize harmful effects to the environment.

Topics marked with an asterisk (\*) could be taught better using a simulator as used in the IMO Model Course 2.06, Oil Tanker Cargo and Ballast Handling Simulator which provides detailed training programme for oil Tanker operations using specially created cargo handling exercises.

## ■ Guidance Notes

### TOPIC 1 DESIGN AND CHARACTERISTICS OF AN OIL TANKER

While the topics in this section may look very similar to those found in Model Course 1.01, Basic Training for Oil and Chemical Tanker Cargo Operations, it should be noted that the objective of this advanced level course is to produce a person that can plan, direct, and carry out safe and environmentally friendly cargo related operations. This person may well be called upon to supervise others as they perform the various cargo related duties. The advanced level, then, should be approached by the instructional staff very differently from the way they might approach the basic level addressed in Model Course 1.01. It may be useful to review certain aspects of the material covered in Model Course 1.01 but the major emphasis here will be a deeper understanding of why oil tankers are constructed as they are and how these construction techniques are aimed at creating safer and more environmentally friendly ships than those of years gone by. The understanding achieved through this course should result in seafarers that are capable of recognizing the various designs and characteristics used in modern tanker construction, of weighing the practical implications posed by the designs they face, and of accounting for these factors as they plan, direct and/or carry out cargo operations. Through this advanced level of understanding, the student may then move on to join the workplace ready to face the various challenges and ever-changing conditions.

## 1.1 General arrangement and construction

Instructors should note that the students in this advanced level course are required to explain, describe, draw or otherwise show a deep knowledge and understanding of the topics covered here. The instructional staff should make every effort to present the material in this light. Rather than reciting facts about the construction and general arrangement of oil tankers, instructors should endeavor to fully explain the reasons why as well as the operational advantages and disadvantages of this or that construction technique. Students should not be asked to memorize thousands of facts related to construction requirements. Instead, they should be encouraged to know where to look for this or that design standard/requirement as they would need to do in the actual workplace.

As an example of the previous guidance, instructors may consider the following text concerning double hull and mid-deck construction. It should be noted that the text seeks to provide a deep understanding of operational concerns rather than superficial facts. This is the type of instruction necessary to produce the advanced level seafarer that can take charge of cargo operations on board oil tankers.

### The Double Hull Tanker

When combined with the effect of the double bottom ballast tanks that effectively raise the centre of gravity of the cargo, there is a consequential large reduction in intact stability. This can readily occur during simultaneous cargo and ballast handling operations and requires careful management of all liquid transfer operations, ideally supported by the provision of appropriate quality operational information on board the double hull tanker in question.

In terms of damage stability, ensuring compliance owing to the intact stability issues referred to above is not easy and much more care needs to be taken in distributing the cargo on board a double hull than single hull tanker. Whilst this task is helped by the use of on board computers, it is underpinned by the need to provide an accurate and comprehensive trim and stability manual, ideally before the ship enters commercial service.

Proper consideration has to be given at the design stage to ensure the provision of sufficient openings to permit good ventilation, because tank entry is a safety critical operation on board any tanker, but especially so in the circumstances mentioned above where access is particularly constrained and the provision of timely assistance especially restricted by the hull's structural configuration.

Ease of access for close up structural inspection is an issue for all oil tankers, especially in the case of the comparatively large single hull tanker cargo and ballast tanks. Rafts, remotely controlled vehicles, both in and out of water, ladder access and staging are all used with varying degrees of success.

In the case of double hull tankers, whilst the double bottom ballast spaces are easier to inspect, this may not be the case for the side tanks unless "inspection friendly" fore and aft stringers, horizontal structural members running the length of the tanks, are provided at convenient heights to serve as platforms for this purpose

In terms of maintenance, failure to maintain the integrity of protective coatings and cathodic protection in ballast tanks in particular has led to leakage, pollution and sometimes fire. Maintenance of the ballast tanks of double hull tankers is just as essential, perhaps even more so since there is two to three times the surface area of internal structure to consider when compared to a single hull tanker. If coating failure of ballast tank structures happens before the end of the projected operational life, then there are significant difficulties associated with re-instating an effective coating system.

### **The Mid Deck Tanker**

The Coulombi egg tanker (CET) is a single hull mid-deck tanker alternative to double-hull tankers, designed to reduce oil loss in cases of collision and grounding.

When the lower or outer cargo tanks are damaged, hydrostatic pressure forces the oil (which is less dense than seawater) up into trunking, the high ballast tanks, or both. Non-return valves prevent captured oil from escaping.

### **Advantages**

A CET carries less ballast area, with the ballast tanks situated in the area most susceptible to collision damage. When damaged, draught and list are anticipated to be less than in a double-hull tanker (as no buoyancy is lost, such as when a double-hull void is flooded), a consideration which may prevent a grounded tanker from becoming stuck. The lower ballast tank area limits the amount of coatings and corrosion liable to occur. This arrangement has very low overall oil loss in event of groundings.

### **Disadvantages**

While accepted by IMO, the USCG has not approved this type of vessel for operation in United States waters, as it fails to meet zero outflow requirements. In case of grounding, a small amount of oil will be lost while in a double-hull vessel, this will likely be contained. Some studies have shown that the double hull will only achieve this zero outflow in a low energy grounding; while in a high energy grounding there is indeed outflow. Nonetheless, the United States has taken the negative view of the mid-deck. There are also some concerns over structural complexity and the use of voids/trunking, which can increase cost & decrease cargo capacity. Finally, the mid-deck design does require that shipboard personnel adhere to proper operational techniques so that the desired hydrostatic pressures are achieved. This reliance on the human element has also contributed to the view taken by the United States.

## **1.15 Pumping arrangement and equipment through Fire-fighting Systems**

As with section 1.1 the focus here should be aimed at an advanced level so that students understand the reasons why. For example, in 1.2 students should understand why specific cargo pumping equipment is chosen for use and what the practical operational implications of these choices are. At the end of the day, the student will have to oversee the safe operation of these pumps. They will also need

to ensure the safety of those spaces that house the equipment. It would be wise for instructional staff to avoid reciting facts regarding the pumping equipment and instead approach the subject matter from the "why" and "how" point of view.

This approach, taken throughout topics 1.2 to 1.15 will best serve the student who must leave the classroom and go on to successfully meet the various challenges and conditions in the workplace. The following text is intended to provide guidance, for a sampling of topics, to instructional staff seeking to properly address the "advanced level" mandated by the STCW Convention and Code. The approach revealed in the following samples can and should be applied, as appropriate, to any and all of topics found in areas 1.2 through 1.15.

### **1.3.19 Explains gas dispersion and variables affecting gas dispersion**

As the hydrocarbon gas displaced during loading, ballasting, gas freeing or purging issues from the vent(s) on the tanker, it immediately starts to mix with the atmosphere.

The hydrocarbon concentration is considerable near the vent but is progressively reduced at some distance above the vent, finally passing below the LFL. At any point below the LFL, it ceases to be of concern as a flammability hazard because it cannot be ignited. That said, the toxicity hazards of the gases leaving the vent must be addressed to ensure the welfare of personnel involved in the cargo operations. It is entirely likely that the hydrocarbon gases will be mixed with inert gas, which in itself poses toxicity concerns.

The instructor should refer to the latest edition of ISGOTT for the specific details thus ensuring that students have a complete understanding of the variables affecting gas dispersion, which are:

Wind Speed, Rate of Flow of Gas, Concentration of Hydrocarbon Gas, Cross-Sectional Area of the Opening, Design of the Vent Outlet and Position of the Vent Outlet.

### **1.6.4 Describes the difference between two major types of inert gas generating systems**

Two major types of gas generating systems have evolved: flue gas and independent generators. In the flue gas system, the inert gas blowers take suction from the boiler uptakes through a scrubber, which removes soot and sulphur compounds and cools the gas. The blowers discharge to the distribution main on deck through a pressure controller and an oxygen content monitor. These systems are well suited to steamships and diesel ships with large boilers to meet cargo pump steam requirements.

#### **1.6.4 Describes the difference between two major types of inert gas generating systems**

Once the inert gas leaves the scrubber both systems are virtually identical and indeed, forward of the deck water seal, they are impossible to differentiate from one another.

#### **1.6.44 Describes once the inert gas leaves the scrubber both systems are virtually identical and indeed, forward of the deck water seal, they are impossible to differentiate from one another.**

Instructors should refer to the IMO publication Inert Gas Systems (IMO reference R4) for diagrams and details on this subject and can find further details regarding these operations in ISGOTT.

- a) The **dilution method** can be achieved when gases are both introduced and vented from the top of the tank or when they are introduced at the bottom of the tank and are vented from the top. When gas is introduced at the bottom of the tank it is normally achieved through a connection between the inert gas deck main (just forward of the mechanical non-return valve) and the bottom cargo lines. Regardless of the entry and exit points the dilution method relies on a chaotic mixing of atmospheres and thus requires that incoming gases arrive at a high velocity. The incoming gas should always enter the tank in such a way as to achieve maximum penetration and thorough mixing throughout the tank.
- b) The **displacement method** requires that incoming gases be introduced at the top of the tank and that they be discharged from the bottom. Without this piping arrangement the required blanketing effect cannot be achieved. Additionally, the operator must ensure a low entry velocity for the incoming gases to minimize turbulence at the interface. The outlet point is often a specially fitted purge pipe extending from within 1 metre of the bottom plating and extending to 2 metres above deck level (to minimize the amount of vapour at deck level).

### **1.9 Slop arrangements**

Unlike the approach taken to address many of the topics covered in this advanced level course the approach taken by the instructor for this section should aim at a basic knowledge. Instructors should note that the Part C of this course only requires that the student be able to state various facts about the slop arrangements. In other words, the depth of the teaching and learning here is comparatively shallow. The student is NOT required to describe or explain, thus making this section of the course fairly similar to the approach one might take at the Basic Level.



## **TOPIC 2 KNOWLEDGE OF PUMP THEORY AND CHARACTERISTICS, INCLUDING TYPES OF CARGO PUMPS AND THEIR SAFE OPERATION**

**INTRODUCTION:** The aft pump room of an oil tanker generally contained three or four large centrifugal cargo pumps and a centrifugal ballast pump. Double suction, single stage pumps were favoured because of their relatively low net positive suction head requirements.

Over the past 50 years, cargo pump capacities have increased with ship size-from 1000 m<sup>3</sup>/hr and about 450 kW (600 bhp) to 5670 m<sup>3</sup>/hr and 2250 kW (3000 bhp).

On ships handling high viscosity cargo, positive displacement pumps were installed. Most of these were screw pumps but some owners preferred the Water cycloid pumps. These can handle suction vacuums of 560 mm (22 in.) Hg to overcome the high friction losses of these cargoes.

In addition, one or more positive displacement pumps were installed for stripping the cargo tanks.

These were usually duplex double-acting reciprocating pumps driven by 7-10 bar (100-150 psig) steam. On occasion, screw or cycloid pumps were used instead.

If more than one pump rooms were available then the forward pump room generally contained reciprocating pumps for stripping the forward tanks, handling ballast in the fore peak and transferring fuel oil, ballast, or cargo from the forward deep tanks. Main cargo pumps in pump rooms were generally driven by a single stage geared turbine in the machinery space with a jack shaft through a gastight bulkhead seal. When most tankers were steam propelled, this was the obvious way to use the high boiler capacity while in port. As the age of the diesel approached, various methods to drive cargo pumps were explored. For VLCCs, where high horsepower was required, steam turbines were still favoured, with steam supplied by a large auxiliary boiler. Smaller ships favoured increased electrical generating capacity and motor driven pumps. Another method of cargo handling, which has come increasingly into use, is the vertical deep well pump. These come in a variety of forms, the earliest and most common being the multi-stage vertical turbine pump. In more recent years, submerged, single stage hydraulic driven pumps have become more common. Deep well pumping arrangements are prevalent on chemical and specialty tankers. On these, each cargo tank has its own pump. On crude oil and product tankers, the deep well pumps are often installed in suction casings, which are attached to the cargo piping system.

### **2.1 Explains pump theory and characteristics**

Pumps are an integral part of many pressure systems. Pumps add energy, or head gains, to the flow to counteract head losses and hydraulic grade differences within the system.

A pump is defined by its characteristic curve, which relates the pump head, or the head added to the system, to the flow rate. This curve is indicative of the ability of the pump to add head at different flow rates. To model behaviour of the pump

system, additional information is needed to ascertain the actual point at which the pump will be operating.

The system operating point is based on the point at which the pump curve crosses the system curve representing the static lift and head losses due to friction and minor losses. When these curves are superimposed, the operating point can easily be found.

As water surface elevations and demands throughout the system change, the static head (Hs) and head losses (HL) vary. This changes the location of the system curve, while the pump characteristic curve remains constant. These shifts in the system curve result in a shifting operating point over time.

### **2.1.2 Explains the factors which can influence pump suction**

Liquid vaporization within a pump intake is called "cavitation". Cavitation reduces a pumps performance and will damage the pump. To understand the occurrence of cavitation, it is important to remember that a liquid will vaporize at a relatively low temperature if its pressure is reduced sufficiently. Pressure on the liquid entering a centrifugal pump is reduced as it moves through the suction eye up until the point at which it starts to be pressurized in the impeller. To prevent cavitation the pressure reduction in the suction eye must be compared to the vapour pressure entering the pump to determine whether the liquid will vaporize.

Cavitations will occur when the pump tries to discharge more cargo than is able to enter the suction i.e. with high viscosity cargo or where the cargo is highly volatile (high RVP cargoes). In such cases, having a positive trim and/or increasing the cargo tank IG pressure could play an important contribution to increase of the cargo pump's NPSH (Net Positive Suction Head) which will improve the suction.

When the level inside the cargo tanks is high the pumps will have a higher suction pressure and show a corresponding increase in flow rates. It has also occurred in the past with some type of pumping arrangements that, due to excessive shore back pressure & height level of shore tanks, causes a filling up of ship's tanks and subsequent overflow, due to poor monitoring.

When the tank ullage is nearing low liquid levels, it is preferable to partially close the discharge valve, rather than reduce pump revolutions, in order to reduce the flow rate (to prevent cavitations i.e. pump sucking gas at suction side due to vortex formation/gasification).

It is worth knowing that a 40% open butterfly valve will allow nearly the same flow rate as a 100% open butterfly valve. RPM may then be reduced as necessary with the above diagram it can be seen that when cargo level in tank is at 'X', a flow rate up to 'X1' can be maintained without fear of cavitation of the pump. When cargo level drops to say level 'Y', the flow rate should be reduced to or below 'Y1' to avoid cavitation. In the tankers this is done by throttling the discharge valve of the cargo line.

### **2.1.3 Explains that the discharge pressure will fluctuate when the liquid boils**

Cavitation is a problem condition which may develop while a centrifugal pump is operating. This occurs when a liquid boils inside the pump due to insufficient suction head pressure. Low suction head causes a pressure below that of vaporization of the liquid, at the eye of the impeller.

The resultant gas which forms causes the formation and collapse of 'bubbles' within the liquid. This, because gases cannot be pumped together with the liquid, causes violent fluctuations of pressure within the pump casing and is seen on the discharge gauge. These sudden changes in pressure cause vibrations which can result in serious damage to the pump and, cause pumping inefficiency.

To overcome cavitation:

- Increase suction pressure if possible.
- Decrease liquid temperature if possible.
- Throttle back on the discharge valve to decrease flow-rate.
- Vent gases off the pump casing.

### **2.1.4 Describes the advantages and disadvantages of different types of pumps used on oil tankers**

#### **Centrifugal pumps:**

Centrifugal pumps are not self priming and will not operate efficiently unless the cargo will flow freely to them by gravity. These pumps do not 'suck' the cargo from the tanks. They expel the cargo from their impellers, creating a void into which oil flows from the cargo tanks under the force of gravity and atmospheric pressure. The pumps must be carefully checked before starting to ensure that their chambers are full of cargo. If the pump is started without filling the chamber it can be 'burned out' in a matter of minutes, requiring an expensive overhaul before it can be used again.

When the cargo discharge is started, the full cargo tanks provide adequate positive head to move the cargo freely to the pump. As discharge proceeds it is important to establish and maintain a good trim by the stern so that the pump inlet remains below the cargo suction inlets in most or all of the cargo tanks.

Once the cargo is flowing freely through the pump, they require little attention, aside from regular inspections, until the tanks feeding them reach a low level. Pumping problems may be encountered when the cargo surface reaches the upper level of the tank bottom framing. While the cargo level is above the frames it can flow freely over them and into the section of the bottom framing containing the suction bellmouth. Once the cargo level falls below the top of the framing, the cargo must flow through the lightening holes and limber holes to reach the suction pipe inlet. If the pump speed is not reduced before the cargo surface reaches the level of the bottom framing, then the suction inlet framing section will be quickly emptied and the pump will 'lose suction'. When that happens the pump usually overspeeds and the turbine overspeed safety trips the throttle closed, to the considerable annoyance of

the engineer (who is invariably doing some repair at the other end of the engine room when this happens).

To avoid the embarrassment of explaining why the pump overspeed, the cargo watch officer must know the height of the ship's bottom framing and slow down the pump while there is still a meter of cargo above that level. The pump speed control and the pump discharge valve can then be manipulated to maintain pump suction and cargo flow until the tank is nearly empty. Main cargo pumps should not be used to drain the tank. The stripping pumps are provided for that purpose. If a full cargo tank of the same grade is available, its suction valve can be opened slightly to 'feed' the pump until the low tank is reduced to stripping level.

### Deepwell pumps

Deepwell pumps are centrifugal pumps designed to be mounted in the cargo tank. They have a special application in chemical carriers, where each tank is fitted with a dedicated pump. This improves the versatility of the chemical or product carrier and minimises the possibility of contamination that can occur when one main cargo pump is used to discharge several products. Their design is best suited for refined products, cargoes with viscosities of 200 cSt or less (although products up to 450 cSt have been pumped).

Because the number of pumps is larger, the individual pumps themselves are smaller and individually require less power. This makes possible the use of explosion-proof electric motors on the tanker deck as prime movers for the pumps. Use of electric motors facilitates direct control of pump start and stop functions from the cargo control room. Power and load are indicated by volt and ampere meters.

With a deepwell pump installation, the need for a pumproom is eliminated, along with the hazards and complications of that space.

The modern deepwell pump is made up of a several centrifugal pumping stages, mounted in series on a common vertical shaft. The shaft and impellers are mounted at the lower end of a pump assembly column, which is lowered into a deep cylindrical well (deepwell). In some installations the bottom of the pump well is recessed into the tanker's double bottom, providing a design which permits 100% drainage without use of stripping pumps.

Modern deepwell pumps are self priming, so that they will take suction from a full cargo tank even if they are started empty of liquid. The self priming feature also permits stripping of cargo tanks to much lower levels than is possible with standard centrifugal pumps. When a tank has been discharged with a deepwell pump only a small, air operated, reciprocating pump (mounted in the bottom of the tank), is needed to strip out the residue and then empty the bottom of the cargo pump well. The more common method of evacuating the deepwell is with an air or nitrogen purge system. The gas is piped through a small-bore line at the base of the pump and pushes the contents up the main discharge riser.

When a cargo tank is being stripped (or drained), with a deepwell pump, the pump cycles as its self-priming function is activated, dropping speed and pitch as it fills with liquid and then increasing in speed and pitch as it loses suction and drops the contents of its discharge column back into the well to re-prime itself. Pump speed should be reduced when stripping (if speed control is available). If the pump is powered hydraulically, it can be regulated to any speed desired to permit maximum cargo recovery.

### Screw pumps

Several 40,000 DWT product tankers have been fitted with gear or screw pumps as main cargo pumps. This provides good cargo recovery with single pump stripping ability, plus flexibility in the use of steam or electric motors as the prime mover. Screw or gear pumps consist of two meshing gears or screws which move the cargo between the pump casing and the gears or screws teeth as the gears/screws are rotated. They are very efficient and particularly suited for pumping high viscosity oils, such as lubricating oils, or molasses.

#### **2.1.5 Describes the equipment for final stripping**

A tanker may have a stripping system made up of independent suction piping, or it may have alternative stripping suction outlets from the main cargo lines.

The first alternative is the most versatile and permits the earliest stripping of tanks after they have been emptied as far as possible by the main cargo pumps. To use a stripping system off the main cargo lines, the main pumps must be either finished their work or stopped. This will tend to delay the discharge.

Stripping suction valves in tanks should be 'globe/check' valves, a special type of valve which acts as a non-return valve when opened only a few turns, but permits full flow when fully opened. These valves are opened fully when stripping begins, then closed to the check position as the tank becomes nearly empty.

Some stripping systems are fitted with 'last litre' (or 'last gallon') suctions, small diameter suction lines connected between the stripping suction valves and a stripping suction block valve. When the tank appears to be empty, the stripping suction valve is closed, leaving the block valve open. The pump then draws through the 'last litre' line suction located in the very corner of the tank a few millimetres above the tank bottom.

Either type of stripping system will normally have two stripping pumps in the pumproom, arranged so that they can be used simultaneously and separately on different groups of tanks.

The stripping discharge piping will include lines to the midship manifold, to the slop tank(s) and possibly to an aft cargo tank which can be used for a stripping accumulation tank. There may also be a stripping overboard discharge line. The overboard valve(s) must be verified to be fully closed and sealed before the stripping pumps are started.

## Stripping pumps

Most stripping pumps are based on an operating principle called 'positive displacement'. The oil which enters the pump is mechanically moved from the suction side to the discharge side. This action creates a vacuum at the suction side of the pump, enabling the pump to 'lift' cargo from the tank into its pumping chambers.

The typical positive displacement pump is a reciprocating pump, normally of duplex (two pumping chambers), double-acting design. The internal mechanism is designed so that the cargo piston pumps on both the upstroke and the downstroke. The key components to the proper function of reciprocating pumps are the condition of the internal cargo valves.

A second type of stripping pump is a rotary or gear pump. These usually consist of two meshing gears which move the cargo between the pump casing and the gear teeth as the gears are rotated. These pumps are usually powered by an electric motor. They are very efficient and particularly suited for pumping high viscosity oils, such as lubricating oils or molasses.

A third method of stripping tanks does not use a pump at all, but a device called an eductor. The eductor obtains its vacuum or 'lift' by use of a drive fluid, normally the stream of cargo from the main cargo pump discharge. The principal advantage of the eductor is that it cannot lose suction or be damaged by being run dry. The disadvantage is that once the main cargo pump is stopped, there is no drive fluid available and no further stripping is possible.

### **2.1.6 Describes the proper starting and operating procedures and how to avoid backflow.**

#### Starting cargo pumps

When the shore has declared that they are ready to receive cargo with all valves open, open the pumproom bulkhead and/or pump suction valves and flood the pump with cargo. The pump casing vent line should be used to verify that the pump is filled with cargo before it is started. When the pump is ready to start, the cargo officer, or first officer, calls the engine room for the pumps to be started. Normally, the watch engineer starts the cargo pump turbine in the engine room. He runs it at slow speed for a few minutes until satisfied with its operation, then assigns control of the turbine/pump speed to the cargo control room control panel.

After pump rotation starts, open the correct manifold valve. When it is apparent that cargo is being discharged (tank ullage increases), the ship advises the shore terminal operator. When the shore terminal operator confirms that cargo is being properly received, begin increasing the pump speed and discharge pressure up to the maximum permitted. This should be done in steps, permitting to make several checks of the machinery, piping and shore connection as the pressure increases. If more pumps are to be used on the same shore line, the first pump(s) should be brought to only moderate speed until all pumps are on line, after which they can be brought up to speed in parallel.

Immediately after the start of the discharge, all inactive tanks must be checked to verify that their ullage is constant and particularly that it is not decreasing (tank filling up).

During this first hour of discharging, frequent inspections of the pumproom, other non-cargo spaces, the water surface in the berth and the deck piping should be made to permit early detection of any malfunctions or leaks.

On ships equipped with electrically driven deepwell pumps, it is important to ensure that the drive motor is started in the low speed range and the pump allowed to stabilise before increasing speeds to the maximum permitted. Ships equipped with deepwell pumps utilise their deck loading lines as discharging lines. Because of this arrangement, it is important to keep the tank discharge valves on all tanks closed until immediately before that tank is ready for discharging.

Starting against back-pressure

Some discharging terminals have an unavoidable level of back pressure which the ship must overcome before cargo will begin moving ashore. At these berths, the manifolds valve should not be opened until the ship's pumps are producing a discharge pressure equal to the shore back-pressure to avoid backflow. An accurate determination of the shore back-pressure must be made before the pump is started. The cargo pump is then started and increased in speed until the manifold pressure equals the shore pressure. The manifold valve is then opened and the pump speed increased, all the while carefully watching the ullage of the first cargo tank being discharged.

If the shore terminal offers booster pumps to assist with discharging against high back-pressure, then the cargo discharge should be started at moderate speed, observing the pump discharge pressure carefully. If the pressure decreases suddenly after a few minutes, it is an indication that the shore booster pumps have been started correctly. If the discharge pressure suddenly increases the cargo watch officer must immediately call the shore terminal asking them to stop the booster pumps. The sudden pressure increase is an indication that the valve alignment of the booster pump(s) may have been reversed, causing the booster pump to deliver cargo toward the ship instead of to the shore tanks.

When booster pumps are in operation, indicate this fact in the logbook as an explanation of low ship discharging pressure (to defend against any later claim by charterers that ship was unable to maintain charter pumping pressure while discharging).

### **2.1. Explains why the actual discharge rate also depends on static and dynamic backpressure of the shore installation**

Looking at the Q-H curve, the pump must operate at some point of this curve. The actual point is determined by the shore curve representing the pressure, which the pump has to work against. This head is partially due to a static pressure (which is determined by the difference in height between the tank ashore and the connection to the ship at the jetty) plus the pressure in the shore tank. To this is added a dynamic pressure, due to resistance in the line and which grows with increasing

output of pumps. Before the start of pumping it is the static pressure, which is measured at the manifold.

### **2.1.8 Explains how shore installations influence the pumping rate**

Safety procedures for the transfer of static accumulator cargoes require the linear flow rates of the cargo within the loading lines, both ashore and on board, to be managed to avoid the generation of static charges during the cargo transfer.

The generation of static is controlled by limiting the flow rate at the tank inlet at the commencement of loading to 1 metre/second. Once cargo has covered the tank inlet, the transfer rate can be increased to provide the maximum allowable linear flow rate as determined by the limiting pipe diameter in the tanker or shore piping, whichever is the smaller.

Due to the varying loading rates that different tankers will require in order to comply with their maximum flow rate requirements, terminals should have the facility to control effectively the pumping rates to tankers loading at its berths.

Similarly, if terminals expect tankers to discharge to empty shore tanks, it may be necessary to use flow control or flow measuring equipment in order to determine that the flow rates in the shore lines and tank inlets are not exceeded, particularly in the initial phase of filling a tank.

When discharging static accumulator oils into shore tanks, the initial flow rate should be restricted to 1 metre/second unless or until the shore tank inlet is covered sufficiently to limit turbulence. For a side entrance (horizontal entrance), the inlet is considered adequately covered if the distance between the top of the inlet and the free surface exceeds 0.6 metres. An inlet pointing downwards is considered sufficiently covered if the distance between the lower end of the pipe and the free surface exceeds twice the inlet diameter. An inlet pointing upwards may require a considerably greater distance to limit turbulence. In floating roof tanks, the low initial flow rate should be maintained until the roof is floating. Similar requirements apply to fixed roof tanks provided with inner floats.

### **2.1.9 Explains the procedure used for pumps running in parallel**

If a ship is to deliver a larger quantity of cargo per time interval than the capacity of one pump, we normally have to use two or more cargo pumps in parallel. From a Pump Curve showing two or more pumps in parallel (Combined Curve) we can calculate the delivery quantity (and discharge head) when two or more pumps are run in parallel.

As the piping characteristics remain the same, the new delivery rate will be high. The performance curve for two pumps run in parallel is the added x-axis values (delivery capacity) for each pump at different delivery heads. If two pumps are run in parallel, the best (cheapest) way is to have one common throttling valve on the discharge line. Any possible imbalance between the two pumps can thereby be counteracted.



**2.1.10 Explains the danger of running two or more pumps in parallel if their characteristics are not exactly the same or if the pumps are running at different speeds.**

Some types of centrifugal pumps are not fitted with a non return valve. If running two or more pumps in parallel if their characteristics are not exactly the same or if the pumps are running at different speeds, the higher flow rate will create a back pressure on the lower flow rate pump which will result in the back flow of cargo and result in filling up that tank.

**2.1.11 Explains why a stripping pump must be self-priming**

Stripping pumps must be self-Priming pumps, designed to have the ability to prime automatically, when operating under a suction lift, to free themselves of entrained gas, as the tank levels reduces and vapour starts entering into the suction side of the pump. Stripping pumps need to continue normal pumping, without losing their prime.

**2.1.12 Explains the different types of prime movers for pumps and their operation and control**

The prime movers are placed in the safe-zone of the engine room allowing free selection of alternative motors depending on power sources available onboard:

Electrical motors:	flange or foot mounted of marine heavy-duty squirrel type of either single speed, two-speed or variable speed.
Steam turbines	of impulse single or multistage type with step-less adjustable speed assembled as one unit.
Diesel engines	of 2 or 4 stroke marine type with clutch.

**2.1.13 Explains the causes and the dangers of overheating pumps and how to prevent it.**

Seals and bearings account for over eighty-five percent (85%) of premature centrifugal pump failure.

Bad operating practices include:

Running the pump dry will cause over-heating and excessive vibration problems that will shorten seal life. Here are some of the common reasons why a pump is run dry:

- Failing to vent the pump prior to start-up.
- Running the tank dry at the end of the operation cycle.

Dead heading the pump can cause severe shaft deflection as the pump moves off of its best efficiency point. This translates to excessive heat that will affect both the seal and the bearings as well as causing the seal faces to open, and the possibility of the impeller contacting the volute when the shaft deflects.

- After a system has been blocked out the pump is started with one or more valves not opened.
- Discharge valves are shut before the pump has been stopped.

To insure longer rotating equipment life it should be kept in mind:

- Mechanical seals have an 85% or more failure rate that is normally correctable. This is causing unnecessary down time and excessive operating expense.
- Know where the best efficiency point (bep.) is on a particular pump, and how far it is safe to operate off the bep. with a mechanical seal installed.
- Know how the pumped product affects the life of the mechanical seal and why environmental controls are necessary.
- Cycling pumps for testing will often cause a mechanical seal failure unless an environmental control has been installed to prevent the failure.
- Mechanical seals should be positioned after the impeller has been adjusted for thermal growth. This is important on any pump that is operated above 100°C or you will experience premature seal failure.
- The stuffing box must be vented on all vertical centrifugal pumps or otherwise air will be trapped at the seal faces that can cause premature failure of many seal designs.
- Most original equipment seal designs cause shaft damage (fretting) necessitating the use of shaft sleeves that weaken the shaft and restrict pump operation to a narrow range at the bep.

#### **2.1.14 Explains the application fo screw pumps on oil tankers**

Screw pumps are of the positive-displacement type and may be mounted either horizontally or vertically. They are found primarily in smaller oil tankers.

Those tankers which carry high-viscosity cargoes such as molasses are fitted with screw pumps.

#### **Pressure surge**

##### **2.2.1 Explains how a pressure surge occurs and what the possible consequences are**

A pressure surge is generated in a pipeline system when there is an abrupt change in the rate of flow of liquid in the line. In tanker loading operations, it is most likely to occur as a result of one of the following:

- Closure of an automatic shutdown valve.
- Slamming shut of a shore non-return valve.
- Slamming shut of a butterfly type valve.
- Rapid closure of a power operated valve.

If the pressure surge in the pipeline results in pressure stresses or displacement stresses in excess of the strength of the piping or its components, there may be a rupture, leading to an extensive spill of oil.

### **2.2.2 Explains the three pressure components in liquid being pumped**

When a pump is used to convey liquid from a feed tank down a pipeline and through a valve into a receiving tank, the pressure at any point in the system while the liquid is flowing has three components:

- Pressure on the surface of the liquid in the feed tank. In a tank with its ullage space open to atmosphere, this pressure is that of the atmosphere.
- Hydrostatic pressure at the point in the system in question.
- Pressure generated by the pump. This is highest at the pump outlet, decreasing commensurately with friction along the line downstream of the pump and through the valve to the receiving tank.

Of these three components, the first two can be considered constant during pressure surge.

### **2.2.3 States that $2L/a$ is known as the pipeline period and defines $L$ as the length of piping and $a$ as the speed of sound in the liquid**

If the pressure is not relieved in any way, the final result is a pressure wave that oscillates throughout the length of the piping system. The maximum magnitude of the pressure wave is the sum of  $P$  and the pump outlet pressure at zero throughput. The final pressure adjustment to achieve this condition leaves the pump as soon as the original surge arrives at the pump and travels down to the valve at the speed of sound. One pressure wave cycle therefore takes a time  $2L/a$  from the instant of valve closure, where  $L$  is the length of the line and  $a$  is the speed of sound in the liquid. This time interval is known as the pipeline period.

In this simplified description, therefore, the liquid at any point in the line experiences an abrupt increase in pressure by an amount  $P$  followed by a slower, but still rapid, further increase until the pressure reaches the sum of  $P$  and the pump outlet pressure at zero throughput.

### **2.2.5 Explains how the closure of a valve can superimpose an additional pressure on the liquid and the effects**

Rapid closure of the valve superimposes a transient pressure upon all three components, owing to the sudden conversion of the kinetic energy of the moving liquid into strain energy, by compression of the fluid and expansion of the pipe wall. To illustrate the sequence of events, the simplest hypothetical case will be considered, i.e. when the valve closure is instantaneous, there is no expansion of the pipe wall, and dissipation due to friction between the fluid and the pipe wall is ignored. This case gives rise to the highest pressures in the system.

When the valve closes, the liquid immediately upstream of the valve is brought to rest instantaneously.

This causes its pressure to rise by an amount  $P$ . In any consistent set of units:

$$P = w a v$$

where:

$w$  is the mass density of the liquid

$a$  is the velocity of sound in the liquid

$v$  is the change in linear velocity of the liquid, i.e. from its linear flow rate before closure.

The cessation of flow of liquid is propagated back up the pipeline at the speed of sound in the fluid and, as each part of the liquid comes to rest, its pressure is increased by the amount  $P$ . Therefore, a steep pressure front of height  $P$  travels up the pipeline at the speed of sound, a disturbance known as a pressure surge.

Upstream of the surge, the liquid is still moving forward and still has the pressure distribution applied to it by the pump. Behind it, the liquid is stationary and its pressure has been increased at all points by the constant amount  $P$ . There is still a pressure gradient downstream of the surge, but a continuous series of pressure adjustments takes place in this part of the pipeline which ultimately results in a uniform pressure throughout the stationary liquid. These pressure adjustments also travel through the liquid at the speed of sound.

When the surge reaches the pump, the pressure at the pump outlet (ignoring the atmospheric and hydrostatic components) becomes the sum of the surge pressure  $P$  and the output pressure of the pump at zero throughput (assuming no reversal of flow), since flow through the pump has ceased. The process of pressure equalisation continues downstream of the pump.

In practical circumstances, the valve closure is not instantaneous and there is then some relief of the surge pressure through the valve while it is closing. The results are that the magnitude of the pressure surge is less than in the hypothetical case and the pressure front is less steep.

At the upstream end of the line, some pressure relief may occur through the pump and this would also serve to lessen the maximum pressure reached. If the effective closure time of the valve is several times greater than the pipeline period, pressure relief through the valve and the pump is extensive and a hazardous situation is unlikely to arise.

### **2.2.6 Explains measures to prevent pressure surges**

Where manually operated valves are used, good operating procedures should avoid pressure surge problems. It is important that a valve at the end of a long pipeline should not be closed suddenly against the flow and all changes in valve settings should be made slowly.

Where motorised valves are installed, several steps can be taken to alleviate the problem:

- Reduce the linear flow rate, i.e. the rate of transfer of cargo, to a value that makes the likely surge pressure tolerable.
- Increase the effective valve closure time. In very general terms, total closure times should be of the order of 30 seconds, and preferably more. Valve

closure rates should be steady and reproducible, although this may be difficult to achieve if spring return valves or actuators are needed to ensure that valves fail safe to the closed position. A more uniform reduction of flow may be achieved by careful attention to valve port design, or by the use of a valve actuator that gives a very slow rate of closure over, say, the final 15% of the port closure.

- Use a pressure relief system, surge tanks or similar devices to absorb the effects of the surge sufficiently quickly.

#### Limitation of Flow Rate to Avoid the Risk of a Damaging Pressure Surge

In the operational context, pipeline length and, very often, valve closure times are fixed and the only practical precaution against the consequences of an inadvertent rapid closure is correct operation of the valves and/or to limit the linear flow rate of the oil to a maximum value related to the maximum tolerable surge pressure.

### **TOPIC 3 PROFICIENCY IN TANKER SAFETY CULTURE AND IMPLEMENTATION OF SAFETY-MANAGEMENT SYSTEM**

This topic is aimed at conveying knowledge and understanding versus the learning and resultant demonstration of a skill. That said, it is important for the instructor to stress that any efforts made toward the creation and maintenance of a successful tanker safety culture cannot be just an intellectual undertaking and certainly cannot be just another paper exercise. Instead, the instructor should inculcate the student with the notion that the various instruments being discussed are living systems and are heavily interrelated. Their development by the IMO and other entities was carried out for good reasons and their successful implementation requires a genuine and sincere effort by those in charge. Safety does begin at the top. Quite simply, the safer the oil tanker is, the less likely it is to be involved in a safety or environmentally related incident.

The instructor should be completely familiar with the relevant instruments including the ISM, COSWP, and TMSA and should make every effort to emphasize those portions that are unique to oil tankers. Excerpts from the instruments can be very helpful in achieving the desired emphasis. Similarly, every effort should be made to highlight how the provisions of these instruments might be implemented differently on an oil tanker than on other ship types. Where possible, case studies or other real life examples might be very useful in maximizing the results of such efforts.

### **TOPIC 4 KNOWLEDGE AND UNDERSTANDING OF MONITORING AND SAFETY SYSTEMS, INCLUDING THE EMERGENCY SHUTDOWN**

There are various guidelines, codes, rules and regulations covering safety and the monitoring of atmosphere in gas dangerous and gas safe zones on an oil tanker which must be carried out regularly, It is important that the trainer emphasizes that it is the combination of technical equipment and the spirit of the operator on implementing safety which relates to assessing risks, and monitoring that the vessel as a unit complies with procedures and manages safety on board oil tankers.

#### **4.8 Demonstrates Calibration and Test Procedures of gas measuring instruments**

Practical display with instruments using recommended calibration gas. Ensure that the student knows the required gas to be used for each type of instrument and that the calibration gas is what the manufacturer prescribes. Give the importance of the correct use of the flow meter.

#### **4.9 Performs Measurement of Oxygen Concentrations Practical display with Instruments.**

The trainees should be allowed to handle various gas measuring instruments as stated in Part A of this course as Teaching Aids "A". Corrections and calibration techniques should be taught during this training.

### **TOPIC 5 LOADING, UNLOADING, CARE AND HANDLING OF CARGO**

In case a simulator is provided, training may be done on a simulator (suggested exercises appended in Part APPENDIX 2)

#### **5.1 Ability to perform cargo measurements and calculations**

The trainees should be able to perform cargo measurements and calculations as specified in Part C of this model course, either on a simulator or by an explanation with the aid of a sketch and the appended diagrams of various gauges used on board oil tankers.

It is important that all relevant information required at management level is readily available. Such information can be ship's ullage tables, ASTM tables, vessel specifications etc.

The instructor needs to be familiar with cargo calculations and measurements at management level, and a demonstration of a loading computer is recommended.

### **TOPIC 6 KNOWLEDGE OF THE EFFECT OF BULK LIQUID CARGOES ON TRIM, STABILITY AND STRUCTURAL INTEGRITY**

Instructors should note that Part C of this course only requires that the student be able to state various facts about the effect of bulk liquid cargoes on trim, stability and structural integrity. In other words, the depth of the teaching and learning here is comparatively shallow. The student is NOT required to describe or explain concepts in any depth as we do not see required in other topic areas, nor is the student learning the whole subject of stability and trim as might be found in Model Course 7.01 or 7.03. The focus here should be on the unique properties of bulk liquids and how they will affect the oil tanker while underway as well as while loading and discharging cargo.

## **TOPIC 7 KNOWLEDGE AND UNDERSTANDING OF OIL CARGO-RELATED OPERATIONS,**

### **7.1 Prepare Loading and Unloading plans**

The trainee must be able to demonstrate the ability to plan all stages of the vessel transfer to include Ballasting and deballasting, and loading or discharging cargo operations so as to avoid exceeding specified draught, trim or list requirements, while at the same time keeping shear force, bending moments and metacentric height within prescribed limits.

Practical demonstration should include preparing a written plan as well as on a vessel load calculator i.e., Loadicator, computer software programme, or on a simulator. The trainee would have to be provided with copies of appropriate ship's capacity, pumping, tank cleaning, ballasting, and ventilation plans along with calibration tables.

ISGOTT Chapter 22 contains details of cargo plans and communications regarding them. (ISGOTT 11.1.1)

Note: The plan should cover all stages of the transfer operations and as a minimum, contain:

- Quantity and grade of each parcel;
- Density, temperature and other relevant properties;
- A plan of the distribution, lines and pumps to be used;
- Transfer rates and maximum allowable pressures;
- Critical stages of the operation;
- Notice of rate change;
- Venting requirements;
- Stability and stress information;
- Drafts and trims;
- Ballast operations;
- Emergency stop procedures;
- Emergency spill procedures and spill containment; and
- Hazards of the particular cargoes.

And also, as required:

- Precautions against static generation;
- Initial start-up rates;
- Control of cargo heating systems;
- Line clearing;
- Crude oil washing procedures;
- Under keel clearance limitations;
- Bunkering; and
- Special precautions required for the particular operation.

-

## **7.2 Ballasting and de-ballasting**

The trainee should have a thorough understanding of the considerations affecting ballast quantity and the tanks to be used, the stages of ballasting and de-ballasting and the associated stresses, and all applicable regulations and procedures for ballast operations at sea and in port.

## **7.3 Tank cleaning**

All tank washing operations should be carefully planned and documented.

Potential hazards relating to planned tank washing operations should be systematically identified, risk assessed and appropriate preventive measures put in place to reduce the risk to as low as reasonably practicable (ALARP).

In planning tank washing operations, the prime risk is fire or explosion arising from simultaneous presence of a flammable atmosphere and a source of ignition. The focus therefore should be to eliminate one or more of the hazards that contribute to that risk, namely the sides of the fire triangle of air/oxygen, ignition source and fuel (i.e. flammable vapours).

Instruction should include washing of tanks in an inert atmosphere and in ships that do not have access to inert gas. The instructor should ensure that the trainee understands that the safety of tank washing in the non-inert condition depends on the integrity of equipment, and implementation of strict procedures to ensure these two hazards are effectively controlled.

### **7.3.2 Describes tank cleaning with: -**

- cold water – fresh or salt water
- hot water – fresh or salt water
- chemicals
- Crude Oil Washing (COW)

### **Cold water wash:**

Normally tank washing will commence with cold water to remove cargo residues.

- Atmosphere testing should be frequent and taken at various levels inside the tank during washing to monitor the change in LFL percentage.
- Consideration should be given to the possible effect of water on the efficiency of the gas measuring equipment and therefore suspend washing when taking readings.
- Mechanical ventilation should, whenever possible, be continued during washing and to provide a free flow of air from one end of the tank to the other.
- The ability to mechanically ventilate concurrent with tank washing is recommended but, where mechanical ventilation is not possible, the monitoring of the tank atmosphere should be more frequent as the likelihood of rapid gas build-up is increased.



If the tank has a venting system that is common to other tanks, the tank must be isolated to prevent ingress of gas from other tanks.

### **Washing with Hot water**

- Heated wash water may be utilized, but if in non inerted conditions, initially only venting has to be done until the atmosphere reaches 10% LEL, washing can then commence and use should be discontinued if the gas concentration reaches 35% of the LFL. A hot wash for a low flashpoint product should ONLY take place following a full (i.e. top to bottom) cold wash cycle.
- If the hot wash water temperature is above 60°C, monitoring of the gas concentration level should be at an increased frequency.

### **Washing with Chemical additives**

- Chemical additives may only be considered if the temperatures of the wash water DOES NOT exceed 60°C.

Steam must never be injected into the tank when tank washing in non-inert conditions and MUST NOT be considered until the tank has been verified as gas free.

### **Crude Oil Washing (COW)**

Before departure on a ballast voyage, after the complete discharge of cargo, sufficient tanks shall have been crude oil washed in accordance with the procedures specified in the vessel's Operations and Equipment Manual to ensure that:

- (a) as a minimum, sufficient tanks have been washed to permit compliance with the draught and trim requirements of regulation 13(2)(a), (b) and (c) of Annex I of MARPOL 73/78 during all phases of the ballast voyage; and
- (b) account is taken of the ship's trading pattern and the expected weather conditions so that additional ballast water is not put into tanks which have not been crude oil washed.

In addition to the tanks referred to in (a) above, approximately one quarter of all remaining tanks shall be crude oil washed for sludge control on a rotational basis, but these additional tanks may include the tanks referred to in (b) above. However, for sludge control purposes, no tank need be crude oil washed more than once in every four months. Crude oil washing shall not be conducted between the final discharge and loading ports; that is to say, no crude oil washing shall be undertaken during the ballast voyage. Ballast water shall not be put into tanks that have not been crude oil washed. Water that is put into a tank which has been crude oil washed but not water rinsed shall be regarded as dirty ballast.

The trainee shall be thoroughly familiar with the requirements and instructions where appropriate, in meeting these COW requirements such as:

- (i) recommended methods and programmes of crude oil washing in order to accord with all foreseeable circumstances of cargo discharge restraints and to obtain maximum trim during the completion of washing and draining of each tank;
- (ii) the procedure on ships to avoid vapour emission in accordance with 6.8;
- (iii) the method of draining tanks which shall include information on optimum trim conditions;
- (iv) the method of draining cargo pumps, cargo lines, crude oil washing lines and stripping lines, the identification of spaces into which they may be drained and procedures for discharge ashore of drainings and strippings via the small-diameter discharge line on completion of cargo discharge;
- (v) typical washing programmes under various conditions of loading specifying:
  - (1) the tanks to be washed;
  - (2) the method for washing each tank, that is, single- or multi-stage;
  - (3) the number of tank washing machines to be used simultaneously;
  - (4) the duration of the crude oil wash and water rinse where the latter is appropriate;
  - (5) the volume of water used for water rinse, which shall be at least equal to that used in the water rinse prior to the inspection; and
  - (6) the preferred order in which the tanks are to be washed;
- (vi) the procedure for draining and stripping, where appropriate, cargo lines and pumps before being used for the loading of departure ballast;
- (vii) the procedure for water washing lines before discharge of departure ballast and the loading and final discharge of arrival ballast;
- (viii) the procedure for verifying by sound patterns that bottom-mounted machines are operating shall be carried out towards the end of the wash cycle for each tank. When carrying out such verification all other machines shall be shut down if necessary;
- (ix) precise details of procedure to ensure compliance with the regulations of Annex I of MARPOL 73/78, as amended, in the discharge of departure ballast, the water flushing of lines and the decanting of the slop tanks at sea.

## 7.4 Inerting

The trainee should have a thorough understanding of the uses of inert gas, the inerting process, and operational considerations to include:

Uses:

- Make operations safer
- Permit COW operations
- Tank washing
- Cargo discharge
- Purge of hydrocarbons from tanks

Inert gas Sources:

- Flue gas from boiler uptakes
  - Steam plants
- Flue gases from an auxiliary boiler
- Produced from an inert gas generator
  - Diesel fired

- Nitrogen Membrane System or Shore supplied nitrogen
- Afterburner of a gas turbine plant

Dilution:

- Introduction of inert gas into tanks at highest possible velocity
- Dilutes any concentration of hydrocarbons or oxygen thru maximum atmospheric agitation
- 3 to 5 atmospheric volume changes

Displacement:

- Introduction of inert gas at low velocity, avoiding atmospheric agitation
- Inert gas is heavier than air
- 1.5 to 2 atmospheric volume changes

Typical problems:

- Improper lineup
- Excess load rate
- Excess discharge rate
- Mechanical
- Constricted line – liquid plug
- Shore vapor recovery problems

Causes of high oxygen:

- Poor combustion control
- Low boiler load
- Leaks on suction side of fans
- Prolonged recirculation
- Uptake valve air seal failure
- Bad oxygen analyzer

The hydrocarbon content must be measured with an appropriate meter designed to measure the percentage of hydrocarbon gas in an oxygen deficient atmosphere. The usual flammable gas indicator is not suitable for this purpose.

## 7.5 Gas freeing

ISGOTT considers tank cleaning and gas freeing the most hazardous period of tanker operations. The trainee should have a thorough understanding of the practical considerations:

Number of tanks

- Portable fans
- IG system in gas free mode

Tank conditions – ISGOTT

- Safe to load
  - Hydrocarbons  $\leq$  40% LFL
- Safe for Workers
- Safe for Hot Work

## Risks – physical and atmospheric

Depends on variables:

- Adequacy of cleaning job
- Time elapsed since previous cleaning
- Quantity of muck in the tank
- Method employed
- Size and complexity of compartment
- Temperature and humidity conditions
- Leakage from adjacent compartments and lines
- Cargoes previously carried

When it is required to gas free a tank after washing, the tank should first be purged with inert gas to reduce the hydrocarbon content to 2% or less by volume to ensure that, during the subsequent gas freeing operation, no portion of the tank atmosphere is brought within the flammable range.

### **7.5.1 Explains how gas-freeing a non-inerted tank will result in the tank atmosphere being in the explosive range for some time**

Referring to the flammability diagram, the trainee should be able to explain that if inert gas is not introduced and only air is introduced into a tank on completion of unloading, the atmosphere will have to pass through the flammable range.

### **7.8.9 Describes COW requirements, Procedures and operations**

*Note: The basics of Crude Oil Washing (COW) are covered in MODEL COURSE 1.01 BASIC TRAINING FOR OIL AND CHEMICAL TANKER CARGO OPERATIONS. A review may be covered dependent upon the level of the trainees. Significant technical and operational complexities associated with Crude Oil Washing (COW) are not covered in MODEL COURSE 1.01 BASIC TRAINING FOR OIL AND CHEMICAL TANKER CARGO OPERATIONS. The trainee must be able to demonstrate an understanding of all that is involved in this fairly complex operation. Additional instructional guidance is needed to address the Advanced Level.*

## **8.0 DEVELOPMENT AND APPLICATION OF CARGO RELATED PLANS, PROCEDURES AND CHECK LISTS.**

8.1 Information to be exchanged between the tanker and the terminal for cargo operations:

- Pre-arrival exchange of information
- Pre-berthing exchange of information
- Pre-transfer exchange of information
- Agreed loading/unloading plans
- Agreement to carry out repairs

Pre-arrival exchange of information (as per ISGOTT, Chapter 22.2)

- Exchange of security information
- Information from tanker to Authorities
- Information from tanker to terminal(s)
- Information from terminal to tanker

Pre-berthing exchange of information (as per ISGOTT, Chapter 22.3)

- Information from tanker to terminal and /or pilot
- Information from terminal and/or pilot to tanker

Pre-transfer exchange of information (as per ISGOTT, Chapter 22.4)

- Information from tanker to terminal
  - Information in preparation for loading cargo and bunkers
  - Information in preparation for cargo discharge
- Information from terminal to tanker
  - Information in preparation for loading cargo and bunkers
  - Information in preparation for cargo discharge

Agreed loading/unloading plans

- Agreed loading plan (as per ISGOTT, Chapter 22.5)
- Agreed discharging plan (as per ISGOTT, Chapter 22.6)

Agreement to carry out repairs (as per ISGOTT, Chapter 22.7)

- If necessary on tanker or terminal

### **8.3 Describes pre-transfer tank inspection procedures**

The trainee should be able to describe pre-transfer tank inspection procedures. This includes both tank inspection procedures before loading and sampling procedures before unloading.

Where possible, inspection of ship's tanks before loading cargo should be made without entering the tanks, ref. ISGOTT Chapter 24.4.

Such tank inspections can be made from the deck using ullage or sighting ports with, where applicable, the inert gas within the tank maintained at its minimum positive pressure. The person inspecting should take care not to inhale cargo vapours or inert gas when inspecting tanks which have not been gas freed.

Frequently, tank atmospheres which are, or which have been, inerted have a blue haze which, together with the size of the tanks, makes it difficult to see the bottom even with the aid of a powerful torch or strong sunlight reflected by a mirror.

Other methods such as dipping and measuring the heel, or having the stripping line or eductors opened in the tank and listening for suction, may have to be used. It may sometimes be necessary to remove tank cleaning opening covers to sight parts of the tank not visible from the ullage or sighting ports, but this should only be done when the tank is gas free, and the covers must be replaced and secured immediately after the inspection.

If, because the cargo to be loaded has a critical specification, it is necessary for the inspector to enter a tank, all the enclosed space entry precautions must be followed. Before entering a tank which has been inerted, it must be gas freed for entry and, unless all tanks are gas freed and the inert gas system is completely isolated, each individual tank to be entered for inspection must be isolated from the inert gas system.

### **8.3.1 Describes procedures for cargo sampling, safety precautions when sampling and safe storage of cargo samples**

Depending on toxicity and/or volatility of the cargo, it may be necessary to prevent or minimize the release of vapour from cargo tank ullage spaces during sampling operations. Whenever possible, sampling should be carried out by use of closed sampling equipment. The use of closed sampling equipment may cause cross-contamination of product samples and, if necessary for cargo quality purposes, open sampling is requested. A risk assessment should be carried out to ascertain whether open sampling can be achieved safely. Risk reducing measures should be taken, e.g. use of appropriate personal protective equipment.

When sampling, care must be taken to avoid inhaling gas and uncontrolled opening of pressurized cargo compartments. Measures must be taken to avoid such safety hazards.

The trainee should be familiar with and able to explain the safety precautions to be taken when sampling in inerted and non-inerted cargo tanks and when sampling cargoes containing toxic substances as per ISGOTT Chapters 11.8.2, 11.8.3 and 11.8.4.

The trainee should be familiar with the procedures for safe storage of cargo samples, as per ISGOTT Chapter 12.3.

### **8.5 Generally describes the checklist and explains the reason and relevance of the check items**

Guidelines for Completing the Ship/Shore Safety Check-List  
Part 'A' – Bulk Liquid General – Physical Checks

1. There is safe access between the ship and shore. The access should be positioned as far away from the manifolds as practicable. The means of access to the ship should be safe and may consist of an appropriate gangway or accommodation ladder with a properly secured safety net fitted to it. Particular attention to safe access should be given where the difference in level between the point of access on the ship and the jetty or quay is large, or is likely to become large. When terminal access facilities are not available and a ship's gangway is used, there should be an adequate landing area on the berth so as to provide the gangway with a sufficient clear run of space and so maintain safe and convenient access to the ship at all states of tide and changes in the ship's freeboard. Near the access ashore, appropriate life-saving equipment should be provided by the

terminal. A lifebuoy should be available on board the ship near the gangway or accommodation ladder. The access should be safely and properly illuminated during darkness. Persons who have no legitimate business on board, or who do not have the Master's permission, should be refused access to the ship.

The terminal should control access to the jetty or berth in agreement with the ship.

2. The ship is securely moored. When considering this item, due regard should be given to the need for adequate fendering arrangements. Ships should remain adequately secured in their moorings. Alongside piers or quays, ranging of the ship should be prevented by keeping all mooring lines taut. Attention should be given to the movement of the ship caused by wind, currents, tides or passing ships and the operation in progress.

Wire ropes and fibre ropes should not be used together in the same direction (i.e. as breast lines, spring lines, head or stern lines) because of the difference in their elastic properties.

Once moored, ships fitted with automatic tension winches should not use such winches in the automatic mode.

Means should be provided to enable quick and safe release of the ship in case of an emergency. In ports where anchors are required to be used, special consideration should be given to this matter. Irrespective of the mooring method used, the emergency release Operation should be agreed, taking into account the possible risks involved. Anchors not in use should be properly secured.

3. The agreed ship/shore communication system is operative. Communication should be maintained in the most efficient way between the Responsible Officer on duty on the ship and the Terminal Representative. When telephones are used, the telephone both on board and ashore should be continuously manned by a person who can immediately contact his respective supervisor. Additionally, the supervisor should have a facility to override all calls. When radio systems are used, the units should preferably be portable and carried by the supervisor or a person who can get in touch with his respective supervisor immediately. Where fixed systems are used, the guidelines for telephones should apply.

The selected primary and back-up systems of communication should be recorded on the check-list and necessary information on telephone numbers and/or channels to be used should be exchanged and recorded.

The telephone and portable radio systems should comply with the appropriate safety requirements.

4. Emergency towing-off pennants are correctly rigged and positioned. Unless the terminal specifically advises to the contrary, emergency towing-off pennants (fire wires) should be positioned on both the off-shore bow and

quarter of the ship. At a buoy mooring, emergency towing-off pennants should be positioned on the side opposite to the hose string.

There are various methods for rigging emergency towing-off pennants currently in use. Some terminals may require a particular method to be used and the ship should be advised accordingly.

5. The ship's fire hoses and fire-fighting equipment are positioned and ready for immediate use.
6. The terminal's fire-fighting equipment is positioned and ready for immediate use.  
Fire-fighting equipment on board and on the jetty should be correctly positioned and ready for immediate use.

Adequate units of fixed or portable equipment should be stationed to cover the ship's cargo deck and the jetty area, having due regard to the presence of both the ship and nearby shore tanks. The shore and ship's fire-main systems should be pressurized or be capable of being pressurized at short notice. Both ship and shore should ensure that their fire-main systems can be inter-connected in a quick and easy way utilizing, if necessary, the International Shore Fire Connection.

7. The ship's cargo and bunker hoses, pipelines and manifolds are in good condition, properly rigged and appropriate for the service intended.
8. The terminal's cargo and bunker hoses or arms are in good condition, properly rigged and appropriate for the service intended. Hoses should be in a good condition and properly fitted and rigged so as to prevent strain and stress beyond design limitations.

All flange connections should be fully bolted and any other types of connections should be properly secured.

Hoses and pipelines and metal arms should be constructed of a material suitable for the substance to be handled, taking into account its temperature and the maximum operating pressure.

Cargo hoses should be indelibly marked so as to allow the identification of the products for which they are suitable, specified maximum working pressure, the test pressure and last date of testing at this pressure. If to be used at temperatures other than ambient, maximum and minimum service temperatures should be marked.

9. The cargo transfer system is sufficiently isolated and drained to allow safe removal of blank flanges prior to connection.

A positive means of confirming that both ship and shore cargo systems are isolated and drained should be in place and used to confirm that it is safe to remove blank flanges prior to connection. The means should provide



protection against pollution due to unexpected and uncontrolled release of product from the cargo system and injury to personnel due to pressure in the system suddenly being released in an uncontrolled manner.

10. Scuppers and save-alls on board are effectively plugged and drip trays are in position and empty.

Where applicable, all scuppers on board should be properly plugged during the operations. Accumulation of water should be drained off periodically.

The ship's manifolds should ideally be provided with fixed drip trays in accordance with OCIMF recommendations.

All drip trays should be emptied in an appropriate manner whenever necessary but always after completion of the specific operation.

When only corrosive liquids or refrigerated gases are being handled, the scuppers may be kept open, provided that an ample supply of water is available at all times in the vicinity of the manifolds.

11. Temporarily removed scupper plugs will be constantly monitored. Scuppers that are temporarily unplugged, in order to drain clean rainwater from the cargo deck for example, must be constantly and closely monitored. The scupper must be re-sealed immediately in the event of a deck oil spill or any other incident that has the potential to cause pollution.

12. Shore spill containment and sumps are correctly managed. Shore containment facilities, such as bund walls, drip trays and sump tanks, should be properly maintained, having been sized for an appropriate containment volume following a realistic risk assessment. Jetty manifolds should ideally be provided with fixed drip trays; in their absence, portable drip trays should be used.

Spill or slop transfer facilities should be well maintained and, if not an automatic system, should be readily available to deal with spilled product or rainwater.

13. The ship's unused cargo and bunker connections are properly secured with blank flanges fully bolted.

14. The terminal's unused cargo and bunker connections are properly secured with blank flanges fully bolted.

Unused cargo and bunker connections should be closed and blanked. Blank flanges should be fully bolted and other types of fittings, if used, properly secured.

15. All cargo, ballast and bunker tank lids are closed.

Apart from the openings in use for tank venting (see Question 29), all openings to cargo, ballast and bunker tanks should be closed and gas tight.

Except on gas tankers, ullaging and sampling points may be opened for the short periods necessary for ullaging and sampling, which activities should be conducted taking account of the controls necessary to avoid electrostatic discharge.

Closed ullaging and sampling systems should be used where required by international, national or local regulations and agreements.

16. Sea and overboard discharge valves, when not in use, are closed and visibly secured.

Experience shows the importance of this item in pollution avoidance on ships where cargo lines and ballast systems are interconnected. Remote operating controls for such valves should be identified in order to avoid inadvertent opening.

If appropriate, the security of the valves in question should be checked visually.

17. All external doors, ports and windows in the accommodation, stores and machinery spaces are closed. Engine room vents may be open.

External doors, windows and portholes in the accommodation should be closed during cargo operations. These doors should be clearly marked as being required to be closed during such operations, but at no time should they be locked.

This requirement does not prevent reasonable access to spaces during operations, but doors should not be left open when unattended.

Engine room vents may be left open. However, consideration should be given to closing them where such action would not adversely affect the safe and efficient operation of the engine room spaces served.

18. The ship's emergency fire control plans are located externally.

A set of fire control plans should be permanently stored in a prominently marked weather-tight enclosure outside the accommodation block for the assistance of shore side fire-fighting personnel. A crew list should also be included in this enclosure.

If the ship is fitted, or is required to be fitted, with an inert gas system (IGS), the following points should be physically checked:

19. Fixed IGS pressure and oxygen content recorders are working.
- All recording equipment should be switched on, tested as per manufacturer's instructions and operating correctly.
20. All cargo tank atmospheres are at positive pressure with oxygen content of 8% or less by volume.
- Prior to commencement of cargo operations, each cargo tank atmosphere should be checked to verify an oxygen content of 8% or less by volume. Inerted cargo tanks should be kept at a positive pressure at all times.
- Part 'B' – Bulk Liquid General – Verbal Verification
21. The ship is ready to move under its own power.
- The ship should be able to move under its own power at short notice, unless permission to immobilize the ship has been granted by the port authority and the Terminal Representative.
- Certain conditions may have to be met for permission to be granted.
22. There is an effective deck watch in attendance on board and adequate supervision of operations on the ship and in the terminal.
- The operation should be under constant control and supervision on the ship and in the terminal.
- Supervision should be aimed at preventing the development of hazardous situations. However, if such a situation arises, the controlling personnel should have adequate knowledge and the means available to take corrective action.
- The controlling personnel on the ship and in the terminal should maintain effective communications with their respective supervisors.
- All personnel connected with the operations should be familiar with the dangers of the substances handled and should wear appropriate protective clothing and equipment.
23. There are sufficient personnel on board and ashore to deal with an emergency.
- At all times during the ship's stay at the terminal, a sufficient number of personnel should be present on board the ship and in the shore installation to deal with an emergency.
24. The procedures for cargo, bunker and ballast handling have been agreed. The procedures for the intended operation should be pre-planned. They should be discussed and agreed upon by the Responsible Officer and Terminal Representative prior to the start of the operations. Agreed arrangements should be formally recorded and signed by both the

Responsible officer and Terminal Representative. Any change in the agreed procedure that could affect the operation should be discussed by both parties and agreed upon. After both parties have reached agreement, substantial changes should be laid down in writing as soon as possible and in sufficient time before the change in procedure takes place. In any case, the change should be laid down in writing within the working period of those supervisors on board and ashore in whose working period agreement on the change was reached.

The operations should be suspended and all deck and vent openings closed on the approach of an electrical storm.

The properties of the substances handled, the equipment of ship and shore installation, and the ability of the ship's crew and shore personnel to execute the necessary operations and to sufficiently control the operations are factors which should be taken into account when ascertaining the possibility of handling a number of substances concurrently.

The manifold areas, both on board and ashore, should be safely and properly illuminated during darkness.

The initial and maximum loading rates, topping-off rates and normal stopping times should be agreed, having regarded to:

- The nature of the cargo to be handled.
- The arrangement and capacity of the ship's cargo lines and gas venting systems.
- The maximum allowable pressure and flow rate in the ship/shore hoses and loading arms.
- Precautions to avoid accumulation of static electricity.
- Any other flow control limitations.
- A record to this effect should be formally made as above.

25. The emergency signal and shutdown procedure to be used by the ship and shore have been explained and understood.  
The agreed signal to be used in the event of an emergency arising ashore or on board should be clearly understood by shore and ship personnel.

An emergency shutdown procedure should be agreed between ship and shore, formally recorded and signed by both the Responsible Officer and Terminal Representative.

The agreement should state the circumstances in which operations have to be stopped immediately.

Due regard should be given to the possible introduction of dangers associated with the emergency shutdown procedure.

26. Material Safety Data Sheets (MSDS) for the cargo transfer have been exchanged where requested.  
An MSDS should be available on request to the receiver from the terminal or ship supplying the product.

As a minimum, such information sheets should provide the constituents of the product by chemical name, name in common usage, UN number and the maximum concentration of any toxic components, expressed as a percentage by volume or as ppm.

27. The hazards associated with toxic substances in the cargo being handled have been identified and understood.

Many tanker cargoes contain components that are known to be hazardous to human health. In order to minimize the impact on personnel, information on cargo constituents should be available during the cargo transfer to enable the adoption of proper precautions. In addition, some port states require such information to be readily available during cargo transfer and in the event of an accidental spill. This is particularly relevant to cargoes that could contain H<sub>2</sub>S, benzene or lead additives.

28. An International Shore Fire Connection has been provided.  
The connection must meet the standard requirements and, if not actually connected prior to commencement of operations, should be readily available for use in an emergency.

29. The agreed tank venting system will be used.  
Agreement should be reached and recorded as to the venting system to be used for the operation, taking into account the nature of the cargo and international, national or local regulations and agreements.  
There are three basic systems for venting tanks:
1. Open to atmosphere via open ullage ports, protected by suitable flame screens.
  2. Fixed venting systems which includes inert gas systems.
  3. To shore through a vapour collection system (see Question 32 below).

30. The requirements for closed operations have been agreed.

It is a requirement of many terminals that, when the ship is ballasting into cargo tanks, loading or discharging, it operates without recourse to opening ullage and sighting ports. In these cases, ships will require the means to enable closed monitoring of tank contents, either by a fixed gauging system or by using portable equipment passed through a vapour lock, and preferably backed up by an independent overfill alarm system.

31. The operation of the P/V system has been verified.  
The operation of the P/V valves and/or high velocity vents should be checked using the testing facility provided by the manufacturer. Furthermore, it is imperative that an adequate check is made, visually or otherwise to ensure

32. Where a vapour return line is connected, operating parameters have been agreed.

Where required, a vapour return line will be used to return flammable vapours from the cargo tanks to shore.

The maximum and minimum operating pressures and any other constraints associated with the operation of the vapour return system should be discussed and agreed by ship and shore personnel.

33. Independent high level alarms, if fitted, are operational and have been tested. Owing to the increasing reliance placed on gauging systems for closed cargo operations, it is important that such systems are fully operational and that backup is provided in the form of an independent overfill alarm arrangement.

The alarm should provide audible and visual indication and should be set at a level that will enable operations to be shutdown prior to the tank being overfilled.

Under normal operations, the cargo tank should not be filled higher than the level at which the overfill alarm is set.

Individual overfill alarms should be tested at the tank to ensure their proper operation prior to commencing loading unless the system is provided with an electronic self-testing capability which monitors the condition of the alarm circuitry and sensor and confirms the instrument set point.

34. Adequate electrical insulating means are in place in the ship/shore connection. Unless measures are taken to break the continuous electrical path between ship and shore pipework provided by the ship/shore hoses or metallic arms, stray electric currents, mainly from corrosion prevention systems, can cause electric sparks at the flange faces when hoses are being connected and disconnected. The passage of these currents is usually prevented by an insulating flange inserted at each jetty manifold outlet or incorporated in the construction of metallic arms. Alternatively, the electrical discontinuity may be provided by the inclusion of one length of electrically discontinuous hose in each hose string.

It should be ascertained that the means of electrical discontinuity is in place, that it is in good condition and is not being by-passed by contact with an electrically conductive material.

35. Shore lines are fitted with a non-return valve, or procedures to avoid back filling have been discussed. In order to avoid cargo running back when discharge from a ship is stopped, either due to operational needs or excessive back pressure, the terminal should confirm that it has a positive system that will prevent unintended flow from the shore facility onto the ship. Alternatively, a procedure should be agreed that will protect the ship.

36. Smoking rooms have been identified and smoking requirements are being observed.

Smoking on board the ship may only take place in areas specified by the Master in consultation with the Terminal Representative. No smoking is allowed on the jetty and the adjacent area, except in buildings and places specified by the Terminal Representative in consultation with the Master.

Places that are directly accessible from the outside should not be designated as places where smoking is permitted. Buildings, places and rooms designated as areas where smoking is permitted should be clearly marked as such.

37. Naked light regulations are being observed. A naked light or open fire comprises the following: flame, spark formation, naked electric light or any surface with a temperature that is equal to or higher than the auto-ignition temperature of the products handled in the operation. The use of naked lights or open fires on board the ship, and within a distance of 25 metres of the ship, should be prohibited, unless all applicable regulations have been met and agreement reached by the port authority, Terminal Representative and the Master.

38. Ship/shore telephones, mobile phones and pager requirements are being observed.

Ship/shore telephones should comply with the requirements for explosion-proof construction, except when placed and used in a safe space in the accommodation. Mobile telephones and pagers should not be used in hazardous areas unless approved for such use by a competent authority.

39. Hand torches (flashlights) are of an approved type. Battery operated hand torches (flashlights) should be of a safe type, approved by a competent authority. Damaged units, even though they may be capable of operation, should not be used.

40. Fixed VHF/UHF transceivers and AIS equipment are on the correct power mode or switched off. Fixed VHF/UHF and AIS equipment should be switched off or on low power (1 watt or less) unless the Master, in consultation with the Terminal Representative, has established the conditions under which the installation may be used safely.

41. Portable VHF/UHF transceivers are of an approved type. Portable VHF/UHF sets should be of a safe type, approved by a competent authority. VHF radio telephone sets may only operate in the internationally agreed wave bands. Equipment should be well maintained. Damaged units, even though they may be capable of operation, should not be used.

42. The ship's main radio transmitter aerials are earthed and radars are switched off. The ship's main radio station should not be used during the ship's stay in port, except for receiving purposes. The main transmitting

aerials should be disconnected and earthed. Satellite communications equipment may be used normally, unless advised otherwise.

The ship's radar installation should not be used unless the Master, in consultation with the Terminal Representative, has established the conditions under which the installation may be used safely.

43. Electric cables to portable electrical equipment within the hazardous area are disconnected from power.

The use of portable electrical equipment on wandering leads should be prohibited in hazardous zones during cargo operations, and the equipment preferably removed from the hazardous zone.

Telephone cables in use in the ship/shore communication system should preferably be routed outside the hazardous zone. Wherever this is not feasible, the cable should be so positioned and protected that no danger arises from its use.

44. Window type air conditioning units are disconnected. Window type air conditioning units should be disconnected from their power supply.

45. Positive pressure is being maintained inside the accommodation, and air conditioning intakes, which may permit the entry of cargo vapours, are closed. A positive pressure should, when possible, be maintained inside the accommodation, and procedures or systems should be in place to prevent flammable or toxic vapours from entering accommodation spaces. This can be achieved by air conditioning or similar systems, which draw clean air from non-hazardous locations. Air conditioning systems should not be operated on 100% recirculation.

46. Measures have been taken to ensure sufficient mechanical ventilation in the pump-room.

Pump rooms should be mechanically ventilated and the ventilation system, which should maintain a safe atmosphere throughout the pump-room, should be kept running throughout cargo handling operations. The gas detection system, if fitted, should be functioning correctly.

47. There is provision for an emergency escape. In addition to the means of access referred to in Question 1, a safe and quick emergency escape route should be available both on board and ashore. On board the ship, it may consist of a lifeboat ready for immediate use, preferably at the after end of the ship, and clear of the moorings.

48. The maximum wind and swell criteria for operations have been agreed. There are numerous factors which will help determine whether cargo or ballast operations should be discontinued. Discussion between the terminal and the ship should identify limiting factors, which could include:  
Wind speed and direction and the effect on hard arms.  
Wind speed and direction and the effect on mooring integrity.



Wind speed and direction and the effect on gangways.

At exposed terminals, swell effects on moorings or gangway safety.

Such limitations should be clearly understood by both parties. The criteria for stopping cargo, disconnecting hoses or arms and vacating the berth should be written in the 'Remarks' column of the check-list.

49. Security protocols have been agreed between the Ship Security Officer and the Port Facility Security Officer, if appropriate.

In states that are signatories to SOLAS, the ISPS Code requires that the Ship Security Officer and the Port Facility Security Officer co-ordinate the implementation of their respective security plans with each other.

50. Where appropriate, procedures have been agreed for receiving nitrogen supplied from shore, either for inerting or purging ship's tanks, or for line clearing into the ship.

Ship and shore should agree in writing on the inert gas supply, specifying the volume required, and the flow rate in cubic metres per minute. The sequence of opening valves before beginning the operation and after completion should be agreed, so that the ship remains in control of the flow. Attention should be given to the adequacy of open vents on a tank in order to avoid the possibility of over-pressurization.

The tank pressure should be closely monitored throughout the operation. The ship's agreement should be sought when the terminal wishes to use compressed nitrogen (or air) as a propellant, either for pigging to clear shore lines into the ship or to press cargo out of shore containment. The ship should be informed of the pressure to be used and the possibility of receiving gas into a cargo tank.

If the ship is fitted, or is required to be fitted, with an inert gas system (IGS) the following statements should be addressed:

51. The IGS is fully operational and in good working order.

The inert gas system should be in safe working condition with particular reference to all interlocking trips and associated alarms, deck seal, non-return valve, pressure regulating control system, main deck IG line pressure indicator, individual tank IG valves (when fitted) and deck P/V breaker.

Individual tank IG valves (if fitted) should have easily identified and fully functioning open/close position indicators.

52. Deck seals, or equivalent, are in good working order.  
It is essential that the deck seal arrangements are in a safe condition. In particular, the water supply arrangements to the seal and the proper functioning of associated alarms should be checked.

53. Liquid levels in pressure/vacuum breakers are correct.

Checks should be made to ensure that the liquid level in the P/V breaker complies with manufacturer's recommendations.

54. The fixed and portable oxygen analysers have been calibrated and are working properly.

All fixed and portable oxygen analysers should be tested and checked as required by the Company and/or manufacturer's instructions and should be operating correctly.

The in-line oxygen analyser/recorder and sufficient portable oxygen analysers should be working properly.

The calibration certificate should show that its validity is as required by the ship's SMS.

55. All the individual tank IG valves (if fitted) are correctly set and locked. For both loading and discharge operations, it is normal and safe to keep all individual tank IG supply valves (if fitted) open in order to prevent inadvertent under or over-pressurization. In this mode of operation, each tank pressure will be the same as the deck main IG pressure and thus the P/V breaker will act as a safety valve in case of excessive over or under-pressure. If individual tank IG supply valves are closed for reasons of potential vapour contamination or de-pressurization for gauging etc., then the status of the valve should be clearly indicated to all those involved in cargo operations. Each individual tank IG valve should be fitted with a locking device under the control of a responsible Officer.

56. All personnel in charge of cargo operations are aware that, in the case of failure of the inert gas plant, discharge operations should cease and the terminal be advised.

In the case of failure of the IG plant, the cargo discharge, de-ballasting and tank cleaning operations should cease and the terminal be advised.

Under no circumstances should the ship's officers allow the atmosphere in any tank to fall below atmospheric pressure.

If the ship is fitted with a crude oil washing (COW) system, and intends to crude oil wash, the following statements should be addressed:

57. The Pre-Arrival COW Check-List, as contained in the approved COW Manual, has been satisfactorily completed.

The approved Crude Oil Washing Manual contains a Pre-Arrival Crude Oil Washing Check-List, specific to each ship, which should be completed by the Responsible Officer prior to arrival at every discharge port where it is intended to undertake Crude Oil Washing.

58. The COW check-lists for use before, during and after COW, as contained in the approved COW Manual, are available and being used.

The approved Crude Oil Washing Manual contains a Crude Oil Washing Check-List, specific to each ship, for use before, during and after Crude Oil Washing operations. This Check-List should be completed at the appropriate times and the Terminal Representative should be invited to participate.

If the ship is planning to tank clean alongside, the following statements should be addressed:

59. Tank cleaning operations are planned during the ship's stay alongside the store installation.

During the pre-transfer discussion between the Responsible Officer and Terminal Representative, it should be established whether any tank cleaning operations are planned while the ship is alongside and the check-list should be annotated accordingly.

60. If 'yes', the procedures and approvals for tank cleaning have been agreed. It should be confirmed that all necessary approvals that may be required to enable tank cleaning to be undertaken alongside have been obtained from relevant authorities. The method of tank cleaning to be used should be agreed, together with the scope of the operation.
61. Permission has been granted for gas freeing operations. It should be confirmed that all necessary approvals that may be required to enable gas freeing to be undertaken alongside have been obtained from the relevant authorities.

Part 'C' – Bulk Liquid Chemicals – Verbal Verification (applicable to oil/chemical carriers)

1. Material Safety Data Sheets are available giving the necessary data for the safe handling of the cargo. Information on the product to be handled should be available on board the ship and ashore and should include:
2. A full description of the physical and chemical properties, including reactivity, necessary for the safe containment and transfer of the cargo.
3. Action to be taken in the event of spills or leaks.
4. Countermeasures against accidental personal contact.
5. Fire-fighting procedures and fire-fighting media.
6. A manufacturer's inhibition certificate, where applicable, has been provided.
7. Where cargoes are required to be stabilized or inhibited in order to be handled, ships should be provided with a certificate from the manufacturer stating:
  8. Name and amount of inhibitor added.
  9. Date inhibitor was added and the normal duration of its effectiveness.

10. Any temperature limitations affecting the inhibitor.
11. The action to be taken should the length of the voyage exceed the effective lifetime of the inhibitor.
12. Sufficient protective clothing and equipment (including self-contained breathing apparatus) is ready for immediate use and is suitable for the product being handled.
13. Suitable protective equipment (including self-contained breathing apparatus and protective clothing) appropriate to the specific dangers of the product handled, should be readily available in sufficient quantity for operational personnel both on board and ashore.
14. Countermeasures against accidental personal contact with the cargo have been agreed.
15. Sufficient and suitable means should be available to neutralize the effects and remove small quantities of spilled products. Should unforeseen personal contact occur, in order to limit the consequences it is important that sufficient and suitable countermeasures are taken.
16. The MSDS should contain information on how to handle such contact with reference to the special properties of the cargo, and personnel should be aware of the procedures to follow.
17. A suitable safety shower and eye rinsing equipment should be fitted and ready for instant use in the immediate vicinity of places on board or ashore where operations regularly take place.
18. The cargo handling rate is compatible with the automatic shutdown system, if in use.
19. Automatic shutdown valves may be fitted on the ship and ashore. The action of these is automatically initiated by, for example, a certain level being reached in the ship or shore tank being filled. Where such systems are used, the cargo handling rate should be established to prevent pressure surges from the automatic closure of valves causing damage to ship or shore line systems.
20. Alternative means, such as a re-circulation system and buffer tanks, may be fitted to relieve the pressure surge created.
21. A written agreement should be made between the Responsible Officer and Terminal Representative indicating whether the cargo handling rate will be adjusted or alternative systems will be used.
22. Cargo system gauges and alarms are correctly set and in good order.
23. Ship and shore cargo system gauges and alarms should be checked regularly to ensure they are in good working order. In cases where it is possible to set alarms to different levels, the alarm should be set to the required level.
24. Portable vapour detection instruments are readily available for the products being handled.
25. The equipment provided should be capable of measuring, where appropriate, flammable and/or toxic levels.
26. Suitable equipment should be available for operational testing of those instruments capable of measuring flammability. Operational testing should be carried out before using the equipment. Calibration

- should be carried out in accordance with the Safety Management System.
27. Information on fire-fighting media and procedures has been exchanged.
  28. Information should be exchanged on the availability of fire-fighting equipment and the procedures to be followed in the event of a fire on board or ashore.
  29. Special attention should be given to any products that are being handled which may be water reactive or which require specialized firefighting procedures.
  30. Transfer hoses are of suitable material, resistant to the action of the products being handled.
  31. Each transfer hose should be indelibly marked so as to allow the identification of the products for which it is suitable, its specified maximum working pressure, the test pressure and last date of testing at this pressure, and, if used at temperatures other than ambient, its maximum and minimum service temperatures.
  32. Cargo handling is being performed with the permanent installed pipeline system.
  33. All cargo transfer should be through permanently installed pipeline systems on board and ashore.
  34. Should it be necessary, for specific operational reasons, to use portable cargo lines on board or ashore, care should be taken to ensure that these lines are correctly positioned and assembled in order to minimize any additional risks associated with their use. Where necessary, the electrical continuity of these lines should be checked and their length should be kept as short as possible.
  35. The use of non-permanent transfer equipment inside tanks is not generally permitted unless specific approvals have been obtained.
  36. Whenever cargo hoses are used to make connections within the ship or shore permanent pipeline system, these connections should be properly secured, kept as short as possible and be electrically continuous to the ship and shore pipeline respectively. Any hoses used must be suitable for the service and be properly tested, marked and certified.
  37. Where appropriate, procedures have been agreed for receiving nitrogen supplied from shore, either for inerting or purging ship's tanks, or for line clearing into the ship.
  38. Ship and shore should agree in writing on the nitrogen supply, specifying the volume required, and the flow rate in cubic metres per minute. The sequence of opening valves before beginning the operation and after completion should be agreed, so that the ship remains in control of the flow. Attention should be given to the adequacy of open vents on a tank in order to avoid the possibility of over-pressurization. The tank pressure should be closely monitored throughout the operation. The ship's agreement should be sought when the terminal wishes to use compressed nitrogen (or air) as a propellant, either for pigging to clear shore lines into the ship or to press cargo out of shore containment. The ship should be informed of the pressure to be used and the possibility of receiving gas into a cargo tank.

## **9.0 ABILITY TO CALIBRATE AND USE MONITORING AND GAS-DETECTION SYSTEMS, INSTRUMENTS AND EQUIPMENT**

A practical demonstration with gas detection equipment of all the gas monitoring equipment in Part A of this model course may be used in order to achieve this learning objective.

Since Gas Detection equipment is constantly being updated and replaced, part of the practical demonstration shall include the ability for the trainee to read the manufacturer's Operating Handbook for the equipment used in the Practical Assessment. During the "Assessments for Calibration" and "Assessments for Use of Gas Detection Systems, Instruments and Equipment", the trainee shall demonstrate that they comprehended and followed the manufacturer's instructions. If Gas Detection Systems, Instruments and Equipment used are approved and incorporated in the simulator for the course, a "Manufacture's Operating Handbook" will be provided for the gas detection equipment for which the simulator is modeled. The purpose is to ensure that the trainees can adapt and know where to find information for specific versions of equipment throughout their career.

### **9.1 Describes the operating principle of:**

#### **9.1.1 A catalytic-filament combustible-gas indicator**

Hydrocarbon gas is measured in the presence of air at concentrations below the Lower Flammable Limit (LFL).

This is to detect the presence of flammable (and potentially explosive) vapours and to detect concentrations of hydrocarbon vapour that may be harmful to personnel. These readings are expressed as a percentage of the Lower Flammable Limit (LFL) and are usually recorded as % LFL. The instruments used to measure % LFL are Catalytic Filament Combustible Gas (CFCG) Indicators, which are usually referred to as Flammable Gas

### **Explosimeters**

Unlike earlier Explosimeters, the pellistor unit balances the voltage and zeros the display automatically when the instrument is switched on in fresh air. In general, it takes about 30 seconds for the pellistor to reach its operating temperature. However the operator should always refer to the manufacturer's instructions for the procedures.

A gas sample may be taken in several ways:

- Diffusion.
- Hose and aspirator bulb (one squeeze equates to about 1 metre of hose length).
- Motorized pump (either internal or external).

Flammable vapours are drawn through a sintered filter (flashback arrestor) into the pellistor combustion chamber. Within the chamber are two elements, the Detector and the Compensator. This pair of elements is heated to between 400 and

600°C. When no gas is present, the resistances of the two elements are balanced and the bridge will produce a stable baseline signal. When combustible gases are present, they will catalytically oxidize on the detector element causing its temperature to rise. This oxidation can only take place if there is sufficient oxygen present. The difference in temperature compared to the compensator element is shown as % LFL.

The reading is taken when the display is stable. Modern units will indicate on the display when the gas sample has exceeded the LFL.

Care should be taken to ensure that liquid is not drawn into the instrument. The use of an in-line water trap and a float probe fitted to the end of the aspirator hose should prevent this occurrence. Most manufacturers offer these items as accessories.

### **9.1.2 Non-Catalytic Heated Filament Gas Indicator (Tankscope)**

#### **Operating Principle**

The sensing element of this instrument is usually a non-catalytic hot filament. The composition of the surrounding gas determines the rate of loss of heat from the filament, and hence its temperature and resistance.

The sensor filament forms one arm of a Wheatstone Bridge. The initial zeroing operation balances the bridge and establishes the correct voltage across the filament, thus ensuring the correct operating temperature.

During zeroing, the sensor filament is purged with air or inert gas that is free from hydrocarbons. As in the explosimeter, there is a second identical filament in another arm of the bridge which is kept permanently in contact with air and which acts as a compensator filament.

The presence of hydrocarbon changes the resistance of the sensor filament and this is shown by a deflection on the bridge meter. The rate of heat loss from the filament is a non-linear function of hydrocarbon concentration and the meter scale reflects this non-linearity. The meter gives a direct reading of % volume hydrocarbons.

When using the instrument, the manufacturer's detailed instructions should always be followed. After the instrument has been initially set at zero with fresh air in contact with the sensor filament, a sample is drawn into the meter by means of a rubber aspirator bulb. The bulb should be operated until the meter pointer comes to rest on the scale (usually within 15-20 squeezes) then aspirating should be stopped and the final reading taken. It is important that the reading should be taken with no flow through the instrument and with the gas at normal atmospheric pressure.

The non-catalytic filament is not affected by gas concentrations in excess of its working scale. The instrument reading goes off the scale and remains in this position as long as the filament is exposed to the rich gas mixture.

### **9.1.3 Inferometer (Refractive Index Meter)**

#### **Operating Principle**

An inferometer is an optical device that utilizes the difference between the refractive indices of the gas sample and air.

In this type of instrument, a beam of light is divided into two and these are then recombined at the eyepiece. The recombined beams exhibit an interference pattern that appears to the observer as a number of dark lines in the eyepiece. One light path is via chambers filled with air. The other path is via chambers through which the sample gas is pumped. Initially, the latter chambers are filled with air and the instrument is adjusted so that one of the dark lines coincides with the zero line on the instrument scale. If a gas mixture is then pumped into the sample chambers, the dark lines are displaced across the scale by an amount proportional to the change of refractive index.

The displacement is measured by noting the new position on the scale of the line that was used initially to zero the instrument. The scale may be calibrated in concentration units or it may be an arbitrary scale whose readings are converted to the required units by a table or graph.

The response of the instrument is linear and a one-point test with a standard mixture at a known concentration is sufficient for checking purposes.

The instrument is normally calibrated for a particular hydrocarbon gas mixture. As long as the use of the instrument is restricted to the calibration gas mixture, it provides accurate measurements of gas concentrations.

The measurement of the concentration of hydrocarbon gas in an inerted atmosphere is affected by the carbon dioxide present when flue gas is used for inerting. In this case, the use of soda lime as an absorbent for carbon dioxide is recommended, provided the reading is corrected appropriately.

The refractive index meter is not affected by gas concentrations in excess of its scale range. The instrument reading goes off the scale and remains in this position as long as the gas chambers are filled with the gas mixture.

### **9.1.4 Chemical indicator tubes**

Probably the most convenient and suitable equipment for measuring very low concentrations of toxic gases on board tankers are chemical indicator tubes.

Chemical indicator tubes consist of a sealed glass tube containing a proprietary filling which is designed to react with a specific gas and to give a visible indication of the concentration of that gas. To use the device, the seals at each end of the glass tube are broken, the tube is inserted in a bellows-type fixed volume displacement hand pump, and a prescribed volume of gas mixture is drawn through the tube at a rate fixed by the rate of expansion of the bellows. A colour change occurs along the tube and the length of discoloration, which is a measure of the gas concentration, is read off a scale integral to the tube.



In some versions of these instruments, a hand operated injection syringe is used instead of a bellows pump.

It is important that all the components used for any measurement should be from the same manufacturer. It is not permissible to use a tube from one manufacturer with a hand pump from another manufacturer. It is also important that the manufacturer's operating instructions are carefully observed.

Since the measurement depends on passing a fixed volume of gas through the glass tube, any use of extension hoses should be in strict accordance with the manufacturer's instructions.

The tubes are designed and intended to measure concentrations of gas in the air. As a result, measurements made in a ventilated tank, in preparation for tank entry, should be reliable.

For each type of tube, the manufacturers must guarantee the standards of accuracy laid down in national standards. Tanker operators should consult the ship's flag administration for guidance on acceptable equipment.

#### **9.1.5 Oxygen meter with paramagnetic sensors**

Oxygen is strongly paramagnetic (i.e. it is attracted by the poles of a magnet but does not retain any permanent magnetism) whereas most other common gases are not. This property means that oxygen content can be measured in a wide variety of gas mixtures.

One commonly used oxygen analyser of the paramagnetic type has a sample cell in which a lightweight body is suspended in a magnetic field.

When sample gas is drawn through the cell, the suspended body experiences a torque proportional to the magnetic susceptibility of the gas. An electric current passing through a coil wound around the suspended body produces an equal and opposing torque. The equalising current is a measure of the magnetic force and is thus a measure of the magnetic susceptibility of the sample, i.e. related to its oxygen content.

Before use, the analyser should be tested with air for a reference point of 21% oxygen and with nitrogen or carbon dioxide for a 0% oxygen reference point.

The analyser readings are directly proportional to the pressure in the measuring cell. The unit is calibrated to a specific atmospheric pressure and the small error due to atmospheric pressure variations can be corrected if required. Continuous samples should be supplied to the instrument by positive pressure. They should not be drawn through the analyser by negative pressure as the measuring pressure then becomes uncertain.

The filter should be cleared or replaced when an increase in sample pressure is required to maintain a reasonable gas flow through the analyser. The same effect is produced if the filter becomes wet due to insufficient gas drying. The need for filter cleaning or replacement should be checked regularly.

### **9.1.6 Oxygen analyser with electrolytic sensor/Electrochemical Sensors**

Analysers of this type determine the oxygen content of a gas mixture by measuring the output of an electrochemical cell. In one commonly used analyser, oxygen diffuses through a membrane into the cell, causing current to flow between two special electrodes separated by a liquid or gel electrolyte.

The current flow is related to the oxygen concentration in the sample and the scale is arranged to give a direct indication of oxygen content. The cell may be housed in a separate sensor head connected by cable to the read out unit.

The analyser readings are directly proportional to the pressure in the measuring cell, but only small errors are caused by normal variations in atmospheric pressure.

Certain gases may affect the sensor and give rise to false readings. Sulphur dioxide and oxides of nitrogen interfere if they are present in concentrations of more than 0.25% by volume. Mercaptans and hydrogen sulphide can poison the sensor if their levels are greater than 1% by volume. This poisoning does not occur immediately but over a period of time; a poisoned sensor drifts and cannot be calibrated in air. In such cases, reference should be made to the manufacturer's instructions.

### **9.1.7 Oxygen analyser with selective chemical absorption liquid**

An oxygen analyser with selective chemical absorption liquid is suitable only for the particular gas analysis or scale range for which it has been manufactured.

Accuracy is within  $\pm 1/2\%$ . The oxygen absorbing fluid is selective in the chemical absorption of oxygen, A typical. Detective element is made of Zirconia electrolyte. It is an oxygen meter designed for I.G.S.

### **9.1.8 Infra-red analyser**

#### **Infra-red (IR) Instruments Operating Principle**

The infra-red (IR) sensor is a transducer for the measurement of the concentration of hydrocarbons in the atmosphere, by the absorption of infra-red radiation.

The vapour to be monitored reaches the measuring chamber by diffusion or by means of a pump. Infra-red light radiation from the light source shines through a window into the chamber, is reflected and focused by the spherical mirror, and then passes through another window and hits the beam splitter. The portion of the radiation that passes through the beam splitter passes through a broadband interference filter (measuring filter) into the housing cover of the measuring detector, and is converted into an electric signal.

The portion of the radiation reflected by the beam splitter passes through the reference filter to reach the reference detector.

If the gas mixture in the chamber contains hydrocarbons, a part of the radiation is absorbed in the wavelength range of the measurement filter, and a reduced electric signal is given. At the same time, the signal of the reference detector remains unchanged. Gas concentration is determined by comparing the relative values of the reference detector and the measuring detector.

Differences in the output of the IR light source, dirt on mirrors and windows as well as dust of aerosols contained in the air have an identical effect on both detectors and are therefore compensated.

### **9.3 Explains why a catalytic-filament combustible-gas indicator is unsuitable for measuring hydrocarbon vapours in an inert atmosphere**

ACFCG Indicator should not be used for measuring hydrocarbon gas in inert atmospheres. Modern flammable gas monitors (Explosimeters) have a poison resistant flammable pellistor as the sensing element. Pellistors rely on the presence of oxygen (minimum 11% by volume) to operate efficiently and for this reason flammable gas monitors should not be used for measuring hydrocarbon gas in inert atmospheres.

## **10.0 ABILITY TO MANAGE AND SUPERVISE PERSONNEL WITH CARGO-RELATED RESPONSIBILITIES**

It must be understood that it is the supervising officer's responsibility for the safe and efficient transfer and retention of oil cargoes. Delegation of duties to other personnel to assist in that responsibility is required, but does not reduce the responsibility of the supervising officer. Therefore, great care and attentiveness must be made to have properly trained crew to assist in any transfer or carriage of oil cargoes and the crew must be supplied with the proper tools, environment, and a plan which they can easily understand.

The plan must include:

- Checks to ensure stresses and stability of the vessel are always within limits
- Suitability of cargo containment prior loading.
- Cargo is loaded, as per stowage plan
- Cargo is cared for during passage with respect to monitoring its parameters, ventilation, cooling, heating etc., as required.
- Cargo is unloaded safely as per plan and that relevant standing/night orders are issued.
- Records for cargo and ballast operations are maintained as per company procedures.
- Records of cargo parameters, soundings of ballast tanks and other spaces are maintained as per company procedures.
- Sufficient qualified personnel are on duty
- Standard language is employed
- Seafarers on cargo watches shall carry out the work as assigned to them by the supervising officer of the watch

Once the plan has been created, it is the Supervising Officer's duty to check that it is being implemented correctly, and to address any changes that may be required.

**An example of a typical Ship Management method of assigning duties that would satisfy the overall plan follows:**

1. The Chief Officer shall attend to all cargo & ballast related operations to direct the operations at the beginning and end of work, before and after the beginning of deballasting operations, under rough weather and sea conditions, during tank cleaning and at all other major steps of the operations.

**Personnel Arrangement during Cargo Operations**

The Chief Officer shall arrange deck crew as follows:

At the beginning and end of cargo work, all officers and deck ratings should be available and positioned at the site in principle.

As far as possible at the beginning of operations, the number of officers present in the Cargo Control Room and monitoring the operations should be more than one.

During cargo work, at least one officer and two deck ratings (including the watch keeper in port) must be on duty as to the cargo work, and one of them must be placed near the manifold. Sufficient crew should be available to man the manifold at all times, as well as to attend the moorings.

The Second and Third Officers should be on duty as cargo watch officer in two shifts, and the Chief Officer must give adequate instructions to the officer on duty. Such instructions, so as to effectively be passed on and monitored for completion, should, as far as possible, be noted down for confirmation.

The duty officer should make use of the white board provided to verify and confirm such instructions execution.

Deck ratings should be on duty as to cargo operations in two or three shifts depending on the case. The watch keeping in port in two or three shifts must be maintained all the times, but the assigned watch keeper in port should also participate and attend to cargo operations, provided his duties are being attended to.

The Chief Officer shall ensure that sufficient personnel are available to safely conduct all activities required for Cargo Oil transfer operations.

The Chief Engineer shall arrange engineers and ratings as follows:  
During cargo transfer operations, the Chief Engineer shall have an engineer & crew member who are well familiar with the cargo handling equipment and machinery of the vessel stay on board in case of any break downs or trouble.

At least for the following operations, assign an engineer on duty to monitor the related machinery and to take necessary measures.

- Start/stop of inert gas system
- Start/stop of cargo pumps located in the engine room
- Crude oil washing related machinery operations
- Start/stop of deck steam or stripping pump
- Start/stop of ballast pump.

The Responsible Engineer shall be present during starting & stopping of cargo operations. Also all critical steps in between shall be attended by him.

The junior engineer shall keep the watches in two shifts.

Further chief engineer may decide to regulate the engineer officers watches as per requirements.

The Chief Engineer shall decide the personnel arrangement and number to be present, in case of any emergency operation of the cargo work equipment and machinery taking crew's ability and the actual conditions of the equipment and machinery into consideration.

The Chief engineer shall ensure that sufficient personnel are available to the support group and must be organized as follows:

When operations are taken over by the port helpers, the ship's crew shall give necessary and detailed information including the characteristics and conditions of machinery and equipment of the vessel. Any specific matters that require attention, cargo operations plan, duty system, emergency response system and communication system, should also be given, so as to enable the port helper to efficiently cope with an emergency during their stay on board.

However, all operations of the port helpers must be carried out under the sole responsibility of the Chief Officer or other person in charge of Cargo operations, of the vessel side.

## **11.0 KNOWLEDGE AND UNDERSTANDING OF THE PHYSICAL AND CHEMICAL PROPERTIES OF OIL CARGOES**

The goal of this General learning Objective would be to use the MSDS efficiently. Unless the physical and chemical properties of some of the hazardous, dangerous and harmful nature of the cargoes carried are not done, the MSDS will not be correctly used.

**Melting** is the process where a solid changes to its liquid state at a certain temperature (called the melting point) and pressure when it is heated.

### ***Melting Point***

Melting Point is the temperature at which the solid and liquid forms of a pure substance can exist in equilibrium.

High melting point cargoes may require special attention. Such cargo may have to be loaded in heated condition and require to be heated during carriage and discharging.

**Products with a high melting Point** should be washed at a temperature of 15-20 C above the melting point. During washing there should be no ballast water or cold cargoes adjacent to the tank to be cleaned. Washing as soon as possible after discharge is recommended.

During loading, discharging and cleaning special attention must be given to liquid and vapor line systems and all instrumentation lines to avoid freezing/solidification. All dead ends should be drained out.

### ***Boiling Point***

Boiling Point is the temperature at which the pressure exerted by the surroundings upon a liquid is equaled by the pressure exerted by the vapour of the liquid. Under this condition, addition of heat results in the transformation of the liquid into its vapour without raising the temperature.

Cargoes with low boiling point will be more volatile and vapourise easily. Care would be required during pumping operations to avoid cavitation. Tank pressures would have to be closely monitored.

Products with a high vapor pressure (higher than some 50 mbar at 20 C) can be removed from the tank by evaporation. As always during ventilation, special care must be taken to prevent the risk of explosion (flammable products) and emission (toxic vapors). All safety and environmental precautions must be taken.

### ***Sublimation***

Sublimation is a process of conversion of a substance from the solid to the vapour state without its becoming liquid.

Crude oil is separated into fractions in the production units. The Gasoline fraction is sublimated at temperatures up to 200°C. Other heavy products boil out at various temperatures and Asphalt remains as a precipitate.

### ***Evaporation***

Evaporation is the process where a liquid changes to its gaseous state below its boiling point.

Low boiling point/ volatile cargoes tend to evaporate rapidly.

Cargoes consisting of mixtures with different vapor pressures should neither be cleaned by evaporation, nor prewashed hot. The evaporation of the light substances from a mixture could result in non-volatile residues, which are very difficult to remove.

**Surface tension** is a contractive tendency of the surface of a liquid that allows it to resist an external force. The cohesive forces among liquid molecules are responsible for the phenomenon of surface tension. In the bulk of the liquid, each molecule is pulled equally in every direction by neighboring liquid molecules, resulting in a net force of zero. The molecules at the surface do not have other molecules on all sides of them and therefore are pulled inwards.

Detergents used in tank cleaning reduce the surface tension of the washing water, thus "lifting off" the residues easily.

### **Cohesion and Adhesion**

Molecules in liquid state experience strong intermolecular attractive forces. When those forces are between like molecules, they are referred to as cohesive forces. For example, the molecules of a water droplet are held together by cohesive forces, and the especially strong cohesive forces at the surface constitute surface tension. The cohesiveness of crude oil is stronger, it will be left on the surface of strengthening members inside the cargo tanks after discharging, to form the protective film, reducing the corrosion, however, the cohesiveness of gasoline is poor, it is difficult to form the protective film.

When the attractive forces are between unlike molecules, they are said to be adhesive forces. The adhesive forces between water molecules and the walls of a glass tube are stronger than the cohesive forces lead to an upward turning meniscus at the walls of the vessel and contribute to capillary action.

### **Hydrostatic pressure**

It is the pressure exerted by a fluid at equilibrium at a given point within the fluid, due to the force of gravity. Hydrostatic pressure increases in proportion to depth measured from the surface because of the increasing weight of fluid exerting downward force from above.

Hydrostatic pressure is one of the components of total pressure at any point in a pumping system when liquid is flowing through it.

The loads to be considered in the structural design of a tanker consist of: ship and cargo weight, hydrostatic internal and buoyancy pressure in still-water, wave loads and dynamic components resulting from wave induced motions. These loads are of variable nature and may be acting simultaneously.

### Internal/External Liquid Pressure Differential

The liquid pressure differential for any combination of internal/external liquid levels, with the ship on even keel or in rolled position will give a deflection of vessels stability as a result of varied hydrostatic pressures.

Some tanker designs facilitate preventing pollution by having designed ships where Oil is transferred through transverse pipes controlled by valves that operate under hydrostatic pressure.

Hydrostatic pressure is also used for calculating and controlling the outflow of oil in case of collision or grounding damage as required by the MARPOL convention.

### **Solubility and Miscibility**

When one substance completely dissolves in another substance, it is said to be soluble in it.

It is best illustrated by a solid dissolving in a liquid. Like salt or sugar dissolving in water. Here, salt/sugar is the solute and water is the solvent.

When two substances completely mix with each other to form a homogeneous solution, they are called miscible. Miscibility is complete solubility. It is generally seen in liquids. For example, water and (ethyl) alcohol are miscible while oil and water are not.

When something is soluble in something else, the solute dissociates into ions. It undergoes a physical change. No such change occurs during miscibility.

**Solubility can be measured.** Sugar is soluble in water to a certain amount. After the solution is saturated, it will just start piling up at the bottom of the vessel.

**Miscibility is absolute.** Either two substances are miscible or they aren't. You can keep adding as much alcohol as you want to water, it will still mix completely.

Water-Soluble substances and water-miscible substances are easy to clean with water, and the solubility of the substances might increase at higher temperatures. The use of a cleaning agent is only advisable for reduction of the cleaning time. Petroleum and its products are generally not miscible with water.

### **Diffusion**

The passive movement (without effort) of molecules or particles from regions of higher to of lower concentrations, e.g. at completion of inerting, tests would show O<sub>2</sub> content below 8%, but once the tank is secured at positive pressure, diffusion of air pockets takes place and the tank atmosphere becomes homogenous.

When considering the diffusion of gases outside cargo tanks, only high gas concentrations in the vented gas are relevant. For this purpose, the gas layer depth will be taken as the distance from the liquid surface to the level above, where the gas concentration is 50% by volume.



Many gas detectors and monitors use diffusion principle for drawing sample.

### **11.1.2 Explains how volatility relates to vapour pressure**

**Volatility** is the tendency of a substance to vaporize. Volatility is directly related to a substance's vapor pressure. At a given temperature, a substance with higher vapor pressure vaporizes more readily than a substance with a lower vapor pressure. The quantity of gas available to be given off by petroleum liquid depends on its volatility which is frequently expressed for purposes of comparison in terms of Reid Vapour Pressure.

A more informative measure of volatility is the True Vapour Pressure but unfortunately this is not easily measured.

### **11.1.4 Explains how cargoes are classified on the basis of vapour pressure and flashpoint**

The higher the vapor pressure of a liquid at a given temperature, the higher the volatility and the lower the normal boiling point of that liquid.

There are many classification systems for defining the flammability characteristics of petroleum liquids, most of which are based on Flashpoint and Reid Vapour Pressure data.

For purpose of handling petroleum cargoes in tankers and terminals, the division of such liquids into the two broad categories of non-volatile and volatile, as defined below, is in general sufficient to ensure that proper precautions can be specified.

#### **Non-Volatile**

Flashpoint of 60°C or above, as determined by the closed cup method of testing.

#### **Volatile**

Flashpoint below 60°C, as determined by the closed cup method of testing.

If there is any doubt as to the characteristics of a cargo, or if a non-volatile cargo is being handled at a temperature above its Flashpoint minus 10°C, it should be treated as volatile petroleum

Flash point is the basis for classification of flammable and combustible liquids because it is directly related to a liquid's ability to generate vapour, i.e., its volatility. Since it is the vapour of the liquid, not the liquid itself that burns vapour generation becomes the primary factor in determining the fire hazard. The expression "low flash - high hazard" applies. Liquids having flash points below ambient storage temperatures generally display a rapid rate of flame spread over the surface of the liquid, since it is not necessary for the heat of the fire to expend its energy in heating the liquid to generate more vapour.

RVP is useful for comparing the volatilities of a wide range of petroleum liquids in a general way. It is, however, of little value in itself as a means of estimating the likely gas evolution in specific situations, mainly because the measurement is made at the standard temperature of 37.8°C and at a fixed gas/liquid ratio.

## **Explains electrostatic accumulation and how to determine which products are considered static accumulators**

When two dissimilar materials come into contact and rub, charge separation occurs at the interface. The interface may be between two solids, a solid and a liquid or two immiscible liquids. Whilst the materials stay in contact and remain immobile, the separated charges remain extremely close together with the voltage difference between the charges of opposite sign remaining very small, hence, no hazard exists.

However, when the charges are widely separated a large voltage or potential difference develops between them and the neighboring space becomes an electrostatic field.

Separated charges attempt to recombine and neutralize each other.

If the material is a good conductor, the recombination of the charge is very rapid and can counteract the separation process and little or no static is accumulated on the material.

If the material is poor conductor the recombination is impeded or retarded and the material retain or accumulate the charge upon it.

Black oils contain a lot of impurities and are good electrical conductors and therefore disperse the charge as soon as it is separated. They are known as non-static accumulator oils.

Refined petroleum products like motor spirits, kerosene and light diesels are poor, electrical conductors and the static charge comes into the tank faster than it can dissipate and therefore accumulates. These are known as static accumulator oils.

If water is mixed with these non-conducting or static accumulator oils, the situation is aggravated.

All distillates must be treated as static accumulators unless they are certified to contain an anti-static additive. Sometimes these anti-static additives are added to, products like kerosene (1 ppm) to prevent it being a static accumulator oil, thus enabling safe handling.

## **11.2 Chemical properties**

### **11.2.1 Explains the difference between 'light' and 'heavy' in practical significance**

Light Crude oil is liquid petroleum that has low density and that flows freely at room temperature. It has low viscosity, low specific gravity and high API gravity due to the presence of a high proportion of light hydrocarbon fractions. It generally has a low wax content as well. On the other hand, heavy crude oil or extra heavy crude oil is any type of crude oil which does not flow easily. It is referred to as "heavy" because its density or specific gravity is higher than that of light crude oil. Heavy crude oil has been defined as any liquid petroleum with an API gravity less than 20°. Extra heavy oil is defined with API gravity below 10.0 °API (API gravity, is a measure of how heavy or light a petroleum liquid is compared to water. If its API gravity is greater

than 10, it is lighter and floats on water; if less than 10, it is heavier and sinks. )

Light crude oil receives a higher price than heavy crude oil on commodity markets because it produces a higher percentage of gasoline and diesel fuel when converted into products by an oil refinery. Heavy crude oil has more negative impact on the environment than its light counterpart since its refinement requires the use of more advanced techniques as well as the use of contaminants

### **11.2.2 Explains the difference between "sweet and sour" crude oil and the practical significance**

Sweet crude oil is considered "sweet" if it contains less than 0.5% sulphur. In comparison, sour crude oil contains impurity sulphur levels more than 0.5%.

Sour crude is a term used to describe crude oil or products containing appreciable amounts of hydrogen sulphide and/or mercaptans.

When the last cargo carried aboard was a sour crude, tests should be made for hydrogen sulphide. If a level in excess of 5 ppm is detected, no personnel should be allowed to work on deck unless they are wearing suitable respiratory protection. It should be noted that TLV-TWA of H<sub>2</sub>S is as low as 5 PPM thus strict precautions need to be taken whenever handling sour crude.

Sweet crude oil contains small amounts of hydrogen sulphide and carbon dioxide and it is commonly used for processing into gasoline, kerosene, and high-quality diesel. Before sour crude oil can be refined into gasoline, impurities need to be removed, therefore increasing the cost of processing. This results in a higher-priced gasoline than that made from sweet crude oil. For this reason sour crude is usually processed into heavy oil such as diesel and fuel oil rather than gasoline to reduce processing costs

### **11.2.3 Explains that many oil products have chemical properties that may pose a hazard that needs to be taken into consideration**

Crude oil is a mixture of many different kinds of organic compounds, many of which are highly toxic and cancer causing (carcinogenic). Oil is "acutely lethal" to fish, that is it kills fish quickly, at a concentration of 4000 parts per million (ppm) (0.4%). Crude oil and petroleum distillates can cause birth defects.

Benzene is present in both crude oil and gasoline and is known to cause leukemia in humans. The compound is also known to lower the white blood cell count in humans, which would leave people exposed to it more susceptible to infections.

Studies have linked benzene exposure in the mere parts per billion (ppb) range to terminal leukemia, and other blood and immune system diseases within 5-15 years of exposure

Exposure to petroleum products like gasoline can affect the skin, eyes and respiratory tract. Petroleum tends to be most dangerous when its fumes are inhaled, but long-term exposure to the skin also carries risks.

If one regularly comes into skin contact with petroleum-based products, the best method for reducing exposure is to wear gloves. If one, for example, has to take samples, ullages frequently, wearing gloves can cut down on skin exposure.

Over time, handling of petroleum products may result in tissue death of the skin. One may develop a dry rash, or have cracked skin. If one is touching petroleum products, then the best method to cut down risk is to wash hands immediately after work.

Petroleum products on the hands may also be transferred to the eyes, if one brings the hands in contact with the eyes. Eye exposure to petroleum may result in burns of the eyes, which can permanently affect sight. Washing hands directly after exposure is recommended to avoid this risk.

### **11.3 Understanding the information contained in a Safety Data Sheet (SDS)**

A **safety data sheet (SDS)**, is an important component of product guide and occupational safety and health. It is intended to provide workers and emergency personnel with procedures for handling or working with that substance in a safe manner and includes information such as physical data (melting point, boiling point, flash point, etc.), toxicity, health effects, first aid, reactivity, storage, disposal, protective equipment, and spill-handling procedures. MSDS formats can vary from source to source, depending on requirements.

It is recommended here that the instructor should conduct an exercise for the trainees to use MSDS.

The Instructor must emphasize that MSDS from different origins will not be uniform and as you read SDSs from different suppliers, you will see that they are not all written in the same way. Most provide information on health effects which would reasonably be anticipated under conditions of normal use, spills or emergencies. Others provide worst case information, describing any known health effect which may possibly occur at any dose, by any route of exposure. Because of these different approaches, one must be cautious in assuming that a certain product is more or less hazardous than another on the basis of information given in this section.

A Safety Data Sheet (SDS) provides basic information on a product. It describes the properties and potential hazards of the material, how to use it safely, and what to do in an emergency.

The SDS is an essential starting point for the development of a complete health and safety program for the material. SDSs are prepared by the manufacturer or supplier of the material.

They tend to be general in nature, since they provide summarized information which tries to address all reasonably anticipated uses of the material. The information on SDSs is organized into sections.

### **11.3.1 Explains and demonstrates the operational use of the SDS**

Use a Sample SDS sheet and explain each section as appended herein under  
It is important to state here that the specific names and content of these sections can vary from one supplier's SDS to another, but are often similar to the 16 sections of the ANSI Standard for SDS preparation, as listed below. If you are using a 9-section SDS, the types of information may be in a different order and under slightly different headings

## **1. Product and Company Identification**

---

The product identifier (normally the product name) appears both on the SDS and on the WHMIS label. To locate the correct SDS, always use the product identifier, not a shortened name that may be used at your workplace. Check that the name of the manufacturer and/or supplier matches the label as well. The SDS and label may also display other identification, such as a product code or catalog number.

## **2. Hazards Identification**

---

The Hazards Identification section describes the ways you may be exposed to the material and the harmful health effects it can have. Effects observed in experimental animals may be included, if they are considered relevant to people.

### **Emergency Overview**

The material's appearance (e.g. colour, physical form, odour) and the most significant immediate concerns, including fire, reactivity and health and environmental hazards are described in this subsection.

### **Regulatory Status**

Information on the regulatory status of the material under the Controlled Products Regulations (WHMIS) and/or the US Hazard Communication Standard may be included in this subsection.

### **Potential Health Effects**

#### **Route of Entry (Primary Routes of Exposure)**

The possible routes of exposure are skin contact, eye contact, inhalation (respiratory system), and ingestion (swallowing). How important each route of entry is for a particular material depends on many factors, such as the physical properties of the material and how it is used. When designing ways to minimize exposure, each Route of Entry needs to be considered. Chemicals can cause harm either at the point of contact, by absorption into the body, or both. Chemicals absorbed into the body can affect body systems and organs far away from the point of entry. For example, phenol absorbed through the skin can cause fatal nervous system and kidney injury.

### **Effects of Acute Exposure to Product**

An acute exposure is one that takes place over a short period of time (minutes, hours or days). Health effects caused by an acute exposure are usually seen at the time of exposure. Sometimes, they may not appear for several hours or even days after an exposure.

You need information on the typical effects of a short-term exposure (signs and symptoms) because they can alert you that you are being accidentally exposed. Any symptoms you experience which may be associated with use of a material should be reported so that your workplace can be investigated to find out the cause. Possible reasons for the symptoms can vary widely. For example, perhaps the material has passed through your gloves, or the ventilation system is not working effectively. Sometimes the symptoms may not be related to an exposure at work; they may be caused by a cold, for example.

### **Effects of Chronic Exposure to Product**

A chronic exposure is a long-term exposure (months or years). Chronic exposures may be described as prolonged, meaning very long, or repeated, meaning many exposures. Any illness related to a chronic exposure may develop very slowly or may not appear until many years after the exposure has stopped. You should be aware that at the time of the exposure you may experience no warning symptoms, but an illness possibly related to the exposure may appear months or years later. If these types of effects are possible for the material you are handling, it is especially important to minimize your exposure by following established safe handling procedures.

### **Irritancy of Product**

Some products can cause irritation (reversible reddening, swelling and pain) if they come into direct contact with the skin, eyes or respiratory tract (nose, breathing airways and lungs). If there is information available about irritancy of the product, for example from tests on experimental animals, it will be indicated in this section.

### **Sensitization to Product**

Sensitization is the development, over time, of an allergic reaction to a chemical. Sensitizers may cause a mild response on the first few exposures but, as the sensitivity develops, the response becomes worse with subsequent exposures. Eventually, even short exposures to low concentrations can cause a very severe reaction.

There are two different types of occupational sensitization: skin and respiratory. Typical symptoms of skin sensitivity are swelling, redness, itching, pain, and blistering. Sensitization of the respiratory system may result in symptoms similar to a severe asthmatic attack. These symptoms include wheezing, difficulty in breathing, chest tightness, coughing and shortness of breath.

### **Carcinogenicity**

Materials are identified as carcinogens if they are recognized as carcinogens by the American Conference of Governmental Industrial Hygienists (ACGIH), or the

International Agency for Research on Cancer (IARC). The lists of carcinogens published by these organizations include known human carcinogens and some materials which cause cancer in animal experiments. Certain chemicals may be listed as suspect or possible carcinogens if the evidence is limited or inconclusive.

### **Potential Environmental Effects**

This subsection describes the potential effects of the material if it is released into the environment, for example whether it will harm fish or wildlife or accumulate in the environment.

## **3. Composition, Information on Ingredients**

---

Potentially hazardous chemical components, by-products and impurities of the product are listed in this section along with the approximate amount (percentage) of each. CAS numbers for the ingredients are usually included as well. These are unique identifiers for chemicals, assigned by the Chemical Abstracts Service (CAS) of the American Chemical Society. Since a chemical can have many different names, this number can be very useful when trying to find more information.

This section may also indicate if one or more of the components is an approved trade secret.

## **4. First Aid Measures**

---

The First Aid Measures section describes actions to be taken immediately in case you are accidentally exposed to the material. The purpose of first aid is to minimize injury and future disability. In serious cases, first aid may be necessary to keep the victim alive.

First aid information needs to be known before you start working with the material. There is no time to find and read the SDS during an emergency. First aid procedures should be periodically reviewed, especially by employees trained to give first aid. All employees should know the location of the facilities and equipment for providing first aid; for example, the eyewash fountains, safety showers and first aid kits.

When medical treatment is necessary, send the SDS, if it is readily available, to the emergency facility with the victim. If the MSDS is not available, you should send the material's label or a labelled container of the material, if it is small enough. Emergency medical responders need to know what the material is and what First Aid Measures have been recommended and used. Occasionally, the SDS has additional instructions (or a Note to Physician) which may be useful to the emergency doctor.

## **5. Fire Fighting Measures**

---

This section describes any fire hazards associated with the material and fire fighting procedures. The information can be used to select the appropriate type of fire

extinguishers and to plan the best response to a fire for a particular work site. Much of the information is intended for firefighters and emergency response personnel. If the material is a potential fire hazard, you should also refer to Section 7 for special handling precautions.

The information in this section, combined with information from Section 7 (Handling and Storage) and Section 10 (Stability and Reactivity) can be used to determine where a certain material should be stored (for example, flammable liquids should be stored in specially designed facilities away from incompatible chemicals).

## **6. Accidental Release Measures**

---

General instructions for responding to an accidental release or cleaning up a spill are provided in this section. Specific information, such as recommended absorbent materials for spill cleanup, may be included. The information is intended to be used mainly by emergency responders and environmental professionals.

## **7. Handling and Storage**

---

In this section, you will find general precautions necessary for the safe handling of the material, including any equipment that may be required. All possible hazards (fire, reactivity, health and environmental) need to be considered when developing safe handling procedures. For example, for dispensing a flammable liquid, the MSDS may suggest electrical grounding and bonding of containers.

The storage recommendations provided in this section provide a good starting point for deciding where and how materials should be stored (e.g. at what temperature). Refer also to Section 5 (Fire Fighting Measures) and Section 10 (Stability and Reactivity).

Much of the information in this section is intended for occupational health and safety professionals or those responsible for designing safe storage / handling facilities.

## **8. Exposure Controls, Personal Protection**

---

This section provides information which is used to develop procedures and practices for working safely with the material. Most SDSs are written to address all reasonably anticipated uses of the material. Because they must address such a wide range of usage situations, the information may not be entirely applicable to your job. A health and safety professional can help you in interpreting the information and assessing its relevance.

### **Exposure Guidelines**

Exposure guidelines, if available, are given for each component. Typically these are occupational exposure limits such as TLVs (Threshold Limit Values), published by the American Conference of Governmental Industrial Hygienists (ACGIH) or other



Government agencies of the country where the product is being handled. Some manufacturers provide their own recommended exposure limits for their products. Legal (regulated) exposure limits in your jurisdiction (provincial, territorial or federal) may be different from those listed on the MSDS. Health and safety professionals use exposure limits as standards when air sampling is conducted.

## **Engineering Controls**

Engineering control systems reduce potential hazards either by isolating the hazard or by removing the hazard from the work environment. They either control the potential hazard at its source (local exhaust ventilation), remove it from the general area (general ventilation) or put up a permanent barrier between the worker and the potential hazard (isolation or enclosure). Engineering control systems are important because they are built into the work process to reduce the hazards automatically.

Substitution of a less hazardous material or industrial process is always the best way to reduce a hazard and should be considered first. Engineering control systems are the next best option and are preferred over other control measures such as the use of personal protective equipment.

You need to make sure that engineering control systems recommended for your job are properly checked and maintained and that they are operating when you are working with the material. If there are changes in the process or materials, the controls may have to be changed as well.

## **Personal Protective Equipment (PPE)**

General guidance is provided on the need for and selection of personal protective equipment.

### **Eye Protection**

Depending on the job you are doing and the type of material you are handling, you may need various levels of eye protection (e.g. safety glasses, chemical safety goggles, a face shield or some combination of these).

### **Skin Protection**

Skin protection includes items such as gloves, aprons, full body suits, and boots. The SDS should tell you the types of rubbers or other materials that provide the best protection against the product you are using. No one material acts as a barrier to all chemicals. It is also important to consider the temperature conditions and the need for materials not easily cut or torn. Sometimes, the SDS may simply advise you to use impervious (resistant) materials. In this case, you need to find out which specific materials are best. You may be able to obtain this information from the product supplier or manufacturer or from a protective clothing supplier or manufacturer. It is also important to maintain your protective clothing or gloves properly and replace them when necessary.

### **Respiratory Protection**

There are many different types of respirators. One type may be effective against some chemicals but may provide little or no protection against others. Selecting the

best respirator for you can be quite complicated. Usually a qualified person must carry out a detailed assessment of the workplace, including all chemicals used and their airborne concentrations and forms. Consequently, complete respiratory protection guidelines generally cannot be given on the SDS. If respirators are required at your work site, a complete respiratory protection program including respirator selection, fit testing, training and maintenance is necessary. The relevant regulatory and consensus standards should be consulted.

### **General Hygiene Considerations**

This subsection provides general hygiene information that is usually not material specific, e.g. "wash thoroughly after handling and before eating or drinking", but is considered good practice.

## **9. Physical and Chemical Properties**

---

You should check that the description (physical state and appearance) of the material on the SDS is the same as the material you have. If it isn't, you may not have the correct SDS. Alternatively, the material may be old or may have decomposed during shipping or storage. In either case, the information on the SDS may not apply, and you should obtain additional advice.

The rest of the information in this section is used to help determine the conditions under which the material may be hazardous. Technical specialists use this information to develop specific work site procedures for exposure control, storage, handling, fire fighting, spill clean-up, etc.

## **10. Stability and Reactivity**

---

This section of the SDS describes any conditions under which the material is unstable or can react dangerously and conditions that should be avoided. Unstable materials may break down (decompose) and cause fires or explosions or cause the formation of new chemicals that have different hazards. Conditions such as heat, sunlight, and aging of the chemical may cause unstable chemicals to break down.

Some chemicals are hazardous because they can polymerize or undergo a chain reaction. This reaction may generate a lot of heat, may generate enough pressure to burst a container, or may be explosive.

Chemicals that can decompose or polymerize often contain additives called stabilizers or inhibitors which reduce or eliminate the possibility of a hazardous reaction.

Incompatible materials are materials which may react violently or explosively if mixed or brought together. These materials should be stored separately and should not be mixed unless special procedures are followed.

You need to be aware of the information in this section so you can store and handle the material safely and avoid mixing incompatible materials.

## **11. Toxicological Information**

---

This section of the SDS contains toxicity information, either for the ingredients of the product or the product as a whole. This information can be quite technical and difficult to interpret. It is used to support the conclusions presented in Potential Health Effects provided in Section 2 - Hazards Identification. If you are uncertain whether the information is relevant to your workplace and your job, you should ask a knowledgeable health and safety professional. When reading about the effects of the material on animals, it is important to remember that the effects are not necessarily the same for people.

### **LD50 (species and route)**

### **LC50 (species)**

These values are obtained from toxicity testing using experimental animals and are used to indicate the short-term poisoning potential of a material (the lower the value, the more toxic the material). LD50 (lethal dose 50%) is the amount of a material, given all at once, which causes the death of 50% of a group of test animals. The LD50 can be determined using any route of exposure, but dermal (applied to skin) and oral (given by mouth) LD50s are most common. If the route of exposure is inhalation, the value is called an LC50, which stands for lethal (airborne) concentration 50%.

## **12. Ecological Information**

---

Ecological Information is not specifically required under WHMIS. If included, this section contains information that is useful in evaluating the environmental impact of the material if it is released (e.g. toxicity to fish, birds, plants and microorganisms). This information is intended mainly for environmental professionals and other company staff evaluating use, disposal or spill control.

## **13. Disposal Considerations**

---

This section of the SDS is intended mainly for environmental professionals. General waste disposal information will normally be included. The SDS does not usually contain all the steps and precautions necessary for adequate hazardous waste disposal. As well, the SDS often does not give the federal, provincial, or local regulations which must be followed. The appropriate authorities for your area should be contacted for this information.

## **14. Transport Information**

---

This section of the SDS is intended for those responsible for shipping the material. If there are special precautions necessary during shipment, they will be provided. The TDG (Transportation of Dangerous Goods) PIN number (product identification

number) will also be provided if the product meets the TDG criteria. The supplier may also include the TDG classification.

## **15. Regulatory Information**

---

Information in this section is aimed primarily at regulatory compliance personnel. Useful references to applicable health, safety and environmental laws and regulations may be provided, along with information on the regulatory status of the product. The WHMIS classification for the product may also be given.

## **16. Other Information**

---

This section is used to provide supplementary information which the author of the data sheet considers important for the safe use of the material (e.g. label text, hazard ratings). Reference sources used in preparing the data sheet are sometimes listed.

The date the SDS was prepared (or the last time it was reviewed or revised) should be indicated. The data sheet will be updated when new information becomes available. You should check that the SDS you are using is less than 3 years old. If it isn't, you need to request an updated SDS from the supplier or manufacturer. You can also use the manufacturer and/or distributor telephone number(s) provided to obtain more safe handling information if you need it.

## **12.0 KNOWLEDGE AND UNDERSTANDING OF THE HAZARDS AND CONTROL MEASURES ASSOCIATED WITH OIL TANKER CARGO OPERATIONS**

### **12.1 Toxicity**

The student should be able to explain the common toxic hazards and the difficulty in measuring certain toxicities:

- Routes of Entry:
  - Skin contact (absorption)
  - Injection
  - Inhalation
  - Ingestion
  
- Effects of exposure:
  - Acute
  - Chronic
  - Ingestion – acute discomfort and nausea
  - Skin contact – irritation to eyes and skin
    - Dermatitis

- High exposure to petroleum gas
  - Paralysis
  - Unconsciousness
  - Eventually death

Toxic load refers to the accumulation of chemicals or molecules that are foreign to our biological systems.

These may originate externally from toxic chemicals in the environment.

The toxicity of petroleum gases can vary widely depending on the major hydrocarbon constituents of the gases. Toxicity can be greatly influenced by the presence of some minor components such as aromatic hydrocarbons (e.g. benzene) and hydrogen sulphide (H<sub>2</sub>S). These components increase the toxic load.

Toxic Load contributes to many health problems. Research has suggested that more than 75% of cancer is caused by diet and environmental factors of increasing toxic loads.

## **12.2 Flammability and explosion**

Combustion or burning is the sequence of exothermic chemical reactions between a fuel and an oxidant accompanied by the production of heat and conversion of chemical species. The release of heat can result in the production of light in the form of either glowing or a flame. Fuels of interest often include organic compounds (especially hydrocarbons) in the gas, liquid or solid phase.

### **12.2.3 Explains and sketches a flammability diagram, describing flammable range, lower flammable limit (LFL) and upper flammable limit (UFL)**

#### **Lower Flammable Limit (LFL)**

Concentration of hydrocarbon gas in the presence of air below which there is insufficient hydrocarbon to support combustion.

#### **Upper Flammable Limit (UFL)**

The concentration of a hydrocarbon gas in air above which there is insufficient oxygen to support combustion.

#### **Flammable range (also referred to as 'Explosive range')**

The range of hydrocarbon gas concentrations in air between the Lower and Upper Flammable (explosive) Limits. Mixtures within this range are capable of being ignited and of burning.

Sketches a flammability diagram and with the aid of the diagram describes the effects on flammability of tank atmosphere during:

- purging
- gas-freeing of cargo tanks

## Flammability Diagram

The flammable range of a hydrocarbon gas/air mixture plotted on a graph would lie along the slanting line AB as shown in the Flammability Diagram in Part D herein and identifies:

DAB - C/H gas/air mixture line

A - Lower flammable limit (LFL)

B - Upper flammable limit (UFL)

F - Minimum O<sub>2</sub> required for combustion (~11 % by volume)

AFB- Flammable envelope

Note: To one side of the line AB, the Flammable Range decreases with decrease in O<sub>2</sub>, i.e. from AB to F and when there is about 11.5% oxygen by volume, the flammable range ceases to exist due to insufficient oxygen to support combustion. The areas on the diagram can then be marked as inert, too lean or too rich outside the enclosed flammable envelope "ABE" and thus are safe with respect to flammability.

In the flammability diagram the LFL of 1% by volume CH and UFL of 10% by volume CH covers the limits of normal hydrocarbon liquids carried on petroleum tankers.

A C/H gas/air mixture would thus be flammable only when the respective percentages of C/H gas and oxygen lie within the "flammable envelope".

If Gas freeing is started from the point (C) on the graph, the path traced by it would be indicated by the line CD, where it shows to be passing through the flammable zone hence entails precautions to be taken against any sources of ignition.

If Purging is carried out from the same point (C) on the graph, the path traced by it would be indicated by the line CG, it will clear the line of dilution and continue until it reaches a mark of 2% hydrocarbon from where gas freeing may be carried out ensuring a safe atmosphere in the tank throughout the purging and gas freeing operations.

### **12.2.5 Explains the dangers of gas dispersion for the ship's accommodation and terminal jetties**

As the hydrocarbon gas displaced during loading, ballasting, gas freeing or purging issues from the vent or vents on the tanker, it immediately starts to mix with the atmosphere.

The hydrocarbon concentration is progressively reduced until, at some distance from the vent, it passes below the LFL. At any point below the LFL, it ceases to be of concern as a flammability hazard because it cannot be ignited.

However, there exists in the vicinity of any vent a flammable zone within which the gas concentration is above the LFL.

There is a potential danger of fire and explosion if this flammable zone reaches any location where there may be sources of ignition, such as:

- Superstructures and accommodation blocks into which the gas can enter through doors, ports or ventilation intakes.
- The cargo deck which, although it is usually regarded as free of sources of ignition, is a work area and thoroughfare.
- An adjacent jetty which, although it is usually regarded as free of sources of ignition, is a work area and thoroughfare.
- Adjacent vessels such as lightering ships, bunker and stores craft, pilot and crew transfer boats and terminal facilities.

## **12.3 Health Hazards**

### **Ingestion**

Petroleum has low oral toxicity, but when swallowed it causes acute discomfort and nausea. There is then a possibility that, during vomiting, liquid petroleum may be drawn into the lungs and this can have serious consequences, especially with higher volatility products, such as gasolines and kerosenes.

### **Describes the effects of petroleum on the skin and in the eyes**

Many petroleum products, especially the more volatile ones, cause irritation and remove essential oils, possibly leading to dermatitis, when they come into contact with the skin. They can also cause irritation to the eyes. Certain heavier oils can cause serious skin disorders on repeated and prolonged contact.

Direct contact with petroleum should always be avoided by wearing the appropriate protective equipment, especially impermeable gloves and goggles.

### **Describes the symptoms of narcosis**

Narcosis, symptoms are similar to the unconsciousness induced by a narcotic drug. The main effects of low concentrations of petroleum gas on personnel are headaches and eye irritation, with diminished responsibility and dizziness similar to intoxication. At high concentrations, these lead to paralysis, insensibility and death.

### **Describes the threshold limit value (TLV - TWA) and that is generally accepted for petroleum gas**

#### **TLV — TWA: Time Weighted Average**

This refers to a time weighted AVERAGE concentration for a normal 8 hour day, in a 40 hour work week in which MOST workers can be exposed REPEATEDLY without adverse effect.

### **Describes STEL**

#### **TLV — STEL: Short Term Exposure Limit**

This is the concentration in which most workers can be exposed CONTINUOUSLY for a SHORT period of time without suffering from irritation, chronic or irreversible

tissue damage, or narcosis to the degree which would impair self-rescue, work efficiency or cause accidents, PROVIDED that the TWA has not been exceeded. Further, a STEL is a 15 minute TWA which should not be exceeded any time during a normal work day even if the worker is within the 8 hour TWA. Exposures ABOVE the TWA and UP TO the STEL should not be longer than 15 minutes and should not exceed 4 times a day.

### **12.3.5 Explains why:**

#### **12.3.5.1 The absence of a smell of gas is insufficient guarantee of its absence**

With an H<sub>2</sub>S exposure in-between 50 to 100 ppm, the Sense of smell starts to break down. It would not be detectable by the person who is exposed to the gas. Prolonged exposure to concentrations at 100 ppm induces a gradual increase in the severity of these symptoms and death may occur after 4–48 hours' exposure.

#### **12.3.5.2 A combustible gas indicator cannot be expected to measure TLV**

The instruments used to measure % LFL are Catalytic Filament Combustible Gas (CFCG) Indicators, which are usually referred to as Flammable Gas Monitors/Explosimeters. CFCG rely on the presence of oxygen (minimum 11% by volume) to operate efficiently. Some compounds can reduce the sensitivity of the gas indicator, Hence a combustible gas indicator cannot be expected to measure TLV.

### **12.3.10 Explains the reasons for a lower oxygen content in enclosed spaces**

Lack of oxygen should always be suspected in all enclosed spaces, particularly if they have contained water or have been subjected to damp or humid conditions, have contained inert gas or are adjacent to, or connected with, other inerted tanks.

As the amount of available oxygen decreases below the normal 21% by volume. Symptoms indicating that an atmosphere is deficient in oxygen may give inadequate notice of danger. While individuals vary in susceptibility, all will suffer impairment if the oxygen level falls to 16% by volume.

### **12.3.11 Describes the symptoms that appear when the oxygen content decreases**

Breathing tends to become faster and deeper, most people would fail to recognize the danger until they were too weak to be able to escape without help. This is especially so when escape involves the exertion of climbing.

## **12.4 Explains the hazards associated with inert gas and how to control them**

### *Toxic Constituents of Inert Gas*

The main hazard associated with inert gas is its low oxygen content. However, inert gas produced by combustion, either in a steam raising boiler or in a separate inert gas generator (flue gas), will contain trace amounts of various toxic gases that may increase the hazard to personnel exposed to it.



The precautions necessary to protect personnel against toxic components of inert gas during tank entry are to gas freeing the atmosphere of a cargo tank from a hydrocarbon gas concentration of about 2% by volume to 1% LFL, and until a steady 21% by volume oxygen reading is obtained, is sufficient to dilute these toxic constituents to below their TLV-TWA.

## **12.5 Electrostatic hazards**

### **12.5.1 Explains what charge separation is and when it occurs**

When two dissimilar materials come into contact and rub, charge separation occurs at the interface. The interface may be between two solids, a solid and a liquid or two immiscible liquids. Whilst the materials stay in contact and remain immobile, the separated charges remain extremely close together with the voltage difference between the charges of opposite sign remaining very small, hence, no hazard exists. However, when the charges are widely separated a large voltage or potential difference develops between them and the neighboring space becomes an electrostatic field.

When the charges are separated, a large voltage difference can develop between them. A voltage distribution is also set up throughout the neighbouring space and this is known as an electrostatic field. Examples of this are:

- The charge on a charged petroleum liquid in a tank produces an electrostatic field throughout the tank, both in the liquid and in the ullage space.
- The charge on a water mist formed by tank

If an uncharged conductor is present in an electrostatic field, it has approximately the same voltage as the region it occupies. Furthermore, the field causes a movement of charge within the conductor; a charge of one sign is attracted by the field to one end of the conductor and an equal charge of the opposite sign is left at the opposite end. Charges separated in this way are known as 'induced charges' and, as long as they are kept separate by the presence of the field, they are capable of contributing to an electrostatic discharge.

### **12.5.2 Explains the process of charge relaxation and factors relevant to relaxation**

Charges that have been separated attempt to recombine. This process is known as 'charge relaxation'. If one or both of the separated materials carrying charge is a very poor electrical conductor, recombination is impeded and the material retains or accumulates the charge upon it. The period of time for which the charge is retained is characterized by the relaxation time of the material, which is related to its conductivity; the lower the conductivity, the greater the relaxation time.

If a material has a comparatively high conductivity, the recombination of charges is very rapid and can counteract the separation process, and consequently little or no static electricity accumulates on the material. Such a highly conductive material can only retain or accumulate charge if it is insulated by means of a poor conductor, and the rate of loss of charge is then dependent upon the relaxation time of this lesser conducting material.

The important factors governing relaxation are therefore the electrical conductivities of the separated materials, of other conductors nearby, such as ship's structure, and of any additional materials that may be interposed between them after their separation.

### **12.5.5 Gives examples of two-electrode discharges and describes when these discharges may cause ignition**

**A two-electrode** is a diffuse discharge from a highly charged non-conductive object to a single blunt conductor that is more rapid than single electrode discharge and releases more energy. It is possible for a two-electrode discharge to ignite gases and vapours. Examples of a two-electrode discharge are:

- Between a conductive sampling apparatus lowered into a tank and the surface of a charged petroleum liquid.
- Between a conductive protrusion (e.g. fixed tank washing machine) or structural member and a charged petroleum liquid being loaded at a high rate.

### **12.5.6 Explains the instantaneous release of energy with respect to:**

- **conductors**
- **liquid non-conductors**
- **solid non-conductors**
- **intermediate liquid & solid non-conductors**

Instantaneous release of energy in the form of a Spark is an almost instantaneous discharge between two conductors where almost all of the energy in the electrostatic field is converted into heat that is available to ignite a flammable atmosphere.

Examples of sparks are:

- Between an unearthed conductive object floating on the surface of a charged liquid and the adjacent tank structure.
- Between unearthed conductive equipment suspended in a tank and the adjacent tank structure.
- Between conductive tools or materials left behind after maintenance when insulated by a rag or piece of lagging.
- Sparks can be incendive if various requirements are met. These include:
  - A discharge gap short enough to allow the discharge to take place with the voltage difference present, but not so short that any resulting flame is quenched.
  - Sufficient electrical energy to supply the minimum amount of energy to initiate combustion

Liquids are considered to be non-conductors when they have conductivities less than 50 pS/m (pico Siemens/metre). Such liquids are often referred to as static accumulators.

Petroleum products, such as clean oils (distillates), frequently fall into this category with a conductivity typically below 10 pS/m. Chemical solvents and highly refined fuels can have conductivities of less than 1 pS/m.

### **12.5.7 Explains the function of anti-static additives**

If the oil has an effective antistatic additive, it is no longer a static accumulator. Although in theory this means that the precautions applicable to a static accumulator can be relaxed, it is still advisable to adhere to them in practice.

The effectiveness of antistatic additives is dependent upon the length of time since the additive was introduced to the product, satisfactory product mixing, other contamination and the ambient temperature. It can never be certain that the product's conductivity is more than 50 pS/m, unless it is continuously measured.

Liquids are considered to be non-conductors when they have conductivities less than 50 pS/m (pico Siemens/metre). Such liquids are often referred to as static accumulators.

Petroleum products, such as clean oils (distillates), frequently fall into this category with a conductivity typically below 10 pS/m. Chemical solvents and highly refined fuels can have conductivities of less than 1 pS/m. If the oil has an effective antistatic additive, it is no longer a static accumulator oil.

### **12.5.8 Explains the electrostatic hazards of equipment permanently mounted in the upper part of a tank, and the measures to minimize the hazards**

Protrusions associated with equipment mounted from the top of a tank, such as fixed washing machines or high level alarms. During the loading of static accumulator oils, this strong electrostatic field may cause electrostatic discharges to the approaching liquid surface.

Metal probes of the type described above can be avoided by installing the equipment adjacent to a bulkhead or other tank structure to reduce the electrostatic field at the probe tip. Alternatively, a support can be added running from the lower end of the probe downward to the tank structure below, so that the rising liquid meets the support at earth potential rather than the insulated tip of a probe. Another possible solution, in some cases, is to construct the probe-like device entirely of a non-conductive material.

### **12.5.9 Explains how operations can cause a charged mist to develop within a tank**

Loading or ballasting over the top (overall) delivers charged liquid to a tank in such a manner that it can break up into small droplets and splash into the tank. This may produce a charged mist as well as an increase in the petroleum gas concentration in the tank.

The charged mist droplets created in the tank during washing give rise to an electrostatic field, which is characterized by a distribution of potential (voltage)

throughout the tank space. The bulkheads and structure are at earth (zero) potential and the space potential increases with distance from these surfaces and is highest at points furthest from them.

#### **12.5.10 Explains the dangers of introducing inert gas or carbon dioxide into a charged atmosphere**

Small particulate matter carried in inert gas can be electrostatically charged. The charge separation originates in the combustion process and the charged particles are capable of being carried through the scrubber, fan and distribution pipes into the cargo tanks.

During the discharge of pressurized liquid carbon dioxide, the rapid cooling which takes place can result in the formation of particles of solid carbon dioxide that become charged on impact and contact with the nozzle. The charge can be significant with the potential for incentive sparks.

#### **12.6 Knowledge and understanding of dangers of non-compliance with relevant rules/regulations.**

All Rules and Regulations are now covered under the requirements of the ISM code and includes MARPOL, SOLAS, FFA, COSWP, etc.

The ISM Code was designed by the IMO to provide a vehicle for shipowners to create their own programmes individually tailored to meet comprehensive international standards for safety and pollution prevention in the operation of vessels. For the first time, the responsibilities of shore-based safety personnel, up to the highest levels of management, and shipboard personnel are integrated in a system designed to eliminate accidents caused by human error. The ISM Code is tangible evidence of the increasing success of the IMO in setting uniform standards worldwide. While vessel owners and operators welcome increased uniformity, many of them have approached the ISM Code with trepidation. Whether viewed as a needed advance in casualty prevention or a burdensome intrusion into a company's internal operations, the Code is being enforced in a vast majority of countries and enforcement is likely to be expanded. Without at least superficial compliance, it will be difficult or impossible for a vessel to enter most ports, be chartered or be covered by insurance.

Without doubt, a company which gives only lip service to the Code will suffer, because non-conformities with its SMS will be evident to anyone who inspects the documentation required therein, and it is certain that the SMS will be inspected after a casualty by government investigators, underwriters and courts. On the other hand, the Code is of great value to prudent owners and operators, as it provides a single system incorporating all aspects of safety policies and procedures. The internal audit and management review elements of the SMS allow such a company to inspect for, recognize and correct problems before they cause casualties.

Initially, the cost of implementation and training may appear to be high, but should be offset by savings resulting from fewer and less serious casualties. Additionally, the costs of compliance with the SMS will appear small in the event of a casualty,

when the company is able to use reports and audits mandated by its SMS to demonstrate affirmatively that it has taken an aggressive stance with regard to safety.

Pollution damage from an oil tanker forming oil blankets in the region of the coastal reefs and the pristine beaches and estuaries for hundreds of kilometres. The entire ecosystem of the area gets damaged from the loss of stretches of coral, fish, sea grass beds, mangroves and fish breeding areas

Microbiological contamination refers to the presence of pathogenic protozoa, bacteria and/or viruses of either human or animal origin that can pose health risks to both humans and aquatic organisms.

Damages that oil pollution may cause, can have severe socio-economic consequences such as:

- Loss in recreational value of coastal waters (socio-economic consequence)
- Loss in quality of seafood products cultured or harvested from a particular area (socio-economic consequence)
- Human health risks associated contact recreation or ingestion of contamination of seafood (socioeconomic consequence).

### **13.0 KNOWLEDGE AND UNDERSTANDING OF SAFE WORKING PRACTICES, INCLUDING RISK ASSESSMENT AND PERSONAL SHIPBOARD SAFETY RELEVANT TO OIL TANKERS:**

Many of the casualties that have occurred in enclosed spaces on ships have resulted from people entering an enclosed space without proper supervision or adherence to agreed procedures. In almost every case, the casualty could have been avoided.

The rapid rescue of personnel who have collapsed in an enclosed space presents particular risk. It is a human reaction to go to the aid of a colleague in difficulties, but far too many additional and unnecessary casualties have occurred from impulsive and ill-prepared rescue attempts.

#### **13.1 Precautions to be taken when entering enclosed spaces, including correct use of different types of breathing apparatus**

The trainee should be able to explain which special procedures for entering of enclosed spaces and cargo tanks can be found in a vessel's SMS. Industry standard, such as ISGOTT can be used for further information, ref ISGOTT Chapter 10 Enclosed spaces.

Before allowing access to the space, the Responsible Officer should ensure that:

- Appropriate atmosphere checks have been carried out.
- Piping, inert gas and ventilation systems have been isolated.
- Effective ventilation will be maintained continuously while the enclosed space is occupied.

- Fixed lighting, such as air-turbo lights, are ready for extended entry periods.
- Approved self-contained, positive pressure breathing apparatus and resuscitation equipment is ready for use at the entrance to the space.
- A rescue harness, complete with lifeline, is ready for immediate use at the entrance to the space.
- A fully charged approved safety torch is ready for immediate use at the entrance to the space.
- A responsible member of the crew is in constant attendance outside the enclosed space, in the immediate vicinity of the entrance and in direct contact with the Responsible Officer.
- All persons involved in the operation should be trained in the actions to be taken in the event of an emergency.
- Lines of communications have been clearly established and are understood by all concerned.
- Names and times of entry will be recorded and monitored by personnel outside the space.

The personnel undertaking the task should ensure that such safeguards are put into effect prior to entering the space.

The personal protective equipment to be used by people entering the space must be prescribed. The following items should be considered:

- Protective clothing including work clothing or protective suits, safety boots, safety helmet, gloves and safety glasses.
- For large spaces, or where climbing access will be undertaken, the wearing of safety harnesses may also be appropriate.
- Approved safety torches.
- Approved UHF radio.
- Personal gas detector or an area gas detector alarm.
- Emergency Escape Breathing Device(s).

### **Self-Contained Breathing Apparatus (SCBA)**

This consists of a portable supply of compressed air contained in a cylinder or cylinders attached to a carrying frame and harness worn by the user. Air is provided to the user through a face mask, which can be adjusted to give an airtight fit. A pressure gauge indicates the pressure in the cylinder and an audible alarm sounds when the supply is running low.

Only positive pressure type sets are recommended for use in enclosed spaces because, as their name implies, these maintain a positive pressure within the face mask at all times.

### **Airline breathing apparatus**

This enables compressed air equipment to be used for longer periods than would be possible using self-contained equipment.

### **13.1.1 Explains that the ship's SMS requires special procedures to be followed if entering an enclosed space**

It is the responsibility of the Company to establish procedures for safe entry of personnel into enclosed spaces. The process of requesting, raising, issuing and documenting permits to enter into an enclosed space should be controlled by procedures in the ship's Safety Management System (SMS). It is the Master's responsibility to ensure that the established procedures for entry into an enclosed space are implemented.

The Master and Responsible Officer are responsible for determining whether entry into an enclosed space may be permitted. It is the duty of the Responsible Officer to ensure:

- That the space is ventilated.
- That the atmosphere in the compartment is tested and found satisfactory.
- That safeguards are in place to protect personnel from the hazards that are identified.

That appropriate means for controlling entry are in place.

Personnel carrying out work in an enclosed space are responsible for following the procedures and for using the safety equipment specified.

### **13.1.2 Demonstrates the procedures required to conduct a risk assessment prior to entry into an enclosed space**

Prior to entry into an enclosed space, a risk assessment should be completed to identify the potential hazards and to determine the safeguards to be adopted. The resulting safe working practice should be documented and approved by the Responsible Officer before being countersigned by the Master, who confirms that the practice is safe and in compliance with the ship's Safety management System. The permit, or other enabling document, should be sighted and completed by the person entering the space, prior to entry.

The controls required for safe entry vary with the task being performed and the potential hazards identified during the risk assessment. However, in most cases, an Entry Permit System will provide a convenient and effective means of ensuring and documenting that essential precautions have been taken and, where necessary, that physical safeguards have been put in place. The adoption of an Entry Permit System, which may include the use of a check-list, is therefore recommended. Permission to continue work should only be given for a period sufficient to complete the task. Under no circumstances should the period exceed one day.

Atmosphere checks must be carried out with a satisfying result before entry is permitted. Readings are found in international and national regulations for enclosed space entry.

Entry into a space that is not gas free or does not contain 21% Oxygen shall only be permitted in cases of an emergency or for unavoidable operational requirements.

The number of persons entering the tanks shall be kept to a minimum required, but will normally be at least two, each wearing the appropriate PPE.

A stand by team and additional appropriate PPE equipped with the required rescue equipment shall be available outside the enclosed space in which entry has been made.

If entry is absolutely required without the tanks being gas free, or with the presence of gas in a tank for operational requirement following shall be completed prior to undertaking such an operation:

- Risk assessment and hazard identification.
- Plan for work including briefing the concerned personnel on the required precautions, proper techniques, PPE requirement & training.
- Emergency response plan shall be prepared in advance and approved by the Master.
- Suitable breathing apparatus, protective clothing and other equipment required for such entry shall be used by the persons entering the tank.

(Only persons suitably trained and capable of dealing with any unexpected event that may be encountered in the tank shall be sent for such an entry after making the supporting team stand by on the scene to assist the personnel in an unlikely event of an incident.)

### **13.1.3 Explains the benefits and limitations of employing an Entry Permit System (checklist)**

The trainees should be able to discuss the benefits and limitations of employing an Entry Permit System (checklist). This discussion can include, but are not limited to elements such as:

- Prevention of accidents
- Time consumed
- Why entry systems are a requirement
- Hazards of enclosed spaces
- Etc.

### **13.1.4 Explains measures to minimize pump-room hazards**

Cargo pump rooms are to be considered as enclosed spaces. However, because of their location, design and the operational need for the space to be routinely entered by personnel, pump rooms present a particular hazard and therefore necessitate special precautions. Because of the potential for the presence of hydrocarbon gas in the pump-room, SOLAS requires the use of mechanical ventilation by extraction to maintain the atmosphere in a safe condition.

A pump-room contains the largest concentration of cargo pipelines of any space within the ship and leakage of a volatile product from any part of this system could lead to the rapid generation of a flammable or toxic atmosphere. The pump-room may also contain a number of potential ignition sources unless formal, structured maintenance, inspection and monitoring procedures are strictly followed.



Ventilation must be switched on at least 30 minutes prior pump room entry

Before starting any cargo operation:

- An inspection should be made to ensure that strainer covers, inspection plates and drain plugs are in position and secure.
- Drain valves in the pump-room cargo system, especially those on cargo oil pumps, should be firmly closed.
- Any bulkhead glands should be checked and adjusted or lubricated, as necessary, to ensure an efficient gas-tight seal between the pump-room and the machinery space.
- During all cargo operations, including loading:
- The pump-room should be inspected at regular intervals to check for leakages from glands, drain plugs and drain valves, especially those fitted to the cargo pumps.
- If the pumps are in use, pump glands, bearings and the bulkhead glands (if fitted) should be checked for overheating. In the event of leakage or overheating, the pump should be stopped.
- No attempt should be made to adjust the pump glands on rotating shafts while the pump is in service.

Formal procedures should be in place to control pump-room entry. The procedure used should be based on a risk assessment, and should ensure that risk mitigation measures are followed and that entries into the space are recorded.

A communications system should provide links between the pump-room, Navigation Bridge, engine room and cargo control room. In addition, audible and visual repeaters for essential alarm systems, such as the general alarm and the fixed extinguishing system alarm, should be provided within the pump-room.

Arrangements should be established to enable effective communication to be maintained at all times between personnel within the pump-room and those outside. Regular communication checks should be made at pre-agreed intervals and failure to respond should be cause to raise the alarm.

VHF/UHF communication should not be used as a primary communication method where it is known that reception may not be reliable or practicable due to noise. Where communication by VHF/UHF is difficult, it is recommended that a standby person is positioned on the pump-room top and that a visual and remote communication procedure is put in place.

The frequency of pump-room entry for routine inspection purposes during cargo operations should be reviewed with a view to minimising personnel exposure.

Notices should be displayed at the pump-room entrance prohibiting entry without formal permission.

Because of the potential for the presence of hydrocarbon gas in the pump-room, SOLAS requires the use of mechanical ventilation by extraction to maintain the atmosphere in a safe condition. The heavier cargo vapours have a tendency to

stagnate at the bottom hence outlet ducts are so designed to permit the removal of hydrocarbon vapours from the bottom of the pump-room.

### **13.1.5 Demonstrates the use of the SCBA and positive pressure breathing apparatus and resuscitation equipment**

The trainee should be able to demonstrate the proper use of SCBA and positive pressure breathing apparatus and resuscitation equipment.

### **13.1.6 Demonstrates the Safeguards for Enclosed Space Entry in accordance with industry standards and legal requirements**

Before allowing access to the space, the Responsible Officer should ensure that:

- Appropriate atmosphere checks have been carried out.
- Piping, inert gas and ventilation systems have been isolated.
- Effective ventilation will be maintained continuously while the enclosed space is occupied.
- Fixed lighting, such as air-turbo lights, are ready for extended entry periods.
- Approved self-contained, positive pressure breathing apparatus and resuscitation equipment is ready for use at the entrance to the space.
- A rescue harness, complete with lifeline, is ready for immediate use at the entrance to the space.
- A fully charged approved safety torch is ready for immediate use at the entrance to the space.
- A responsible member of the crew is in constant attendance outside the enclosed space, in the immediate vicinity of the entrance and in direct contact with the Responsible Officer.
- All persons involved in the operation should be trained in the actions to be taken in the event of an emergency.
- Lines of communications have been clearly established and are understood by all concerned.
- Names and times of entry will be recorded and monitored by personnel outside the space.

The personnel undertaking the task should ensure that such safeguards are put into effect prior to entering the space.

## **13.2 Precautions to be taken before and during repair and maintenance work**

Permit to Work systems are widely used throughout the petroleum industry. The permit is essentially a document which describes the work to be done and the precautions to be taken in doing it, and which sets out all the necessary safety procedures and equipment.

For operations in hazardous and dangerous areas, permits should normally be used for tasks such as:

- Hot Work.
- Work with a spark potential.
- Work on electrical equipment.

- Diving operations.
- Heavy lifts.

The permit should specify clearly the particular item of equipment or area involved, the extent of work permitted, the conditions to be met and the precautions to be taken and the time and duration of validity. The latter should not normally exceed a working day. At least two copies of the permit should be made, one for the issuer and one for the person at the work site.

The layout of the permit should include a check-list to provide both the issuer and the user with a methodical procedure to check that it is safe for work to begin and to stipulate all the necessary conditions. If any of the conditions cannot be met, the permit should not be issued until remedial measures have been taken.

It is advisable to have distinctive Permit to Work systems for different hazards. The number of permits required will vary with the complexity of the planned activity. Care must be taken not to issue a permit for subsequent work that negates the safety conditions of an earlier permit.

For example, a permit should not be issued to break a flange adjacent to an area where a Hot Work permit is in force.

Before issuing a permit, the Terminal Representative must be satisfied that the conditions at the site, or of the equipment to be worked on, are safe for the work to be performed, taking due account of the presence of any ships that will be alongside while the work is being carried out.

While companies will develop their own procedures for managing all aspects of operations and tasks undertaken, many operators choose to incorporate a Permit to Work system into their SMS in order to manage hazardous tasks.

A Permit to Work system is a formal written system that is used to control certain types of work. It delivers a risk based approach to safety management and requires personnel to undertake and record risk assessments in the development of a safe system of work.

Guidance for establishing a Permit to Work system is contained in a number of publications issued by industry organizations and various international safety bodies.

### **13.2.1 Demonstrates the safeguards before and during maintenance work in accordance with industry standards and legal requirements**

Work planning meetings should be held to ensure that operations and maintenance tasks are correctly planned and managed with the aim of completing all tasks safely and efficiently. These meetings may include discussion of:

- Risk assessments.
- Work permits.
- Isolation and tagging requirements.
- The need for safety briefings, tool box talks and correct procedures.

The format and frequency of work planning meetings should be in accordance with the requirements of the company's SMS, and will be determined by the ship's activities.

It may be appropriate to have two levels of meetings – one on a management level and one that addresses the practical issues associated with carrying out specific tasks. A hazardous task is defined as a task, other than Hot Work, which presents a hazard to the ship, terminal or personnel, the performance of which needs to be controlled by a risk assessment process, such as a Permit to Work system.

Hot work Permits are required to be made in compliance to company SMS procedures where safe and hazardous areas have been classified. Restrictions if any are to be strictly complied with.

It follows that, for each hazardous task, a work permit or controlled procedure should be developed and approved.

The procedure, approval and record of compliance should be retained within the SMS records. Hazardous tasks should only be carried out alongside a terminal with prior agreement of the Terminal Representative.

Examples of such tasks are:

- Enclosed space entry.
- Tank inspections.
- Diving operations.
- Blanking sea chests.

### **13.2.2 Describes the benefits and limitations of the permit to work system, i.e.:**

- Enclosed Space Entry
- Cold Work
- Hot Work
- Electrical isolation
- Working aloft
- Working on pressurized vessel
- Working over the side (outboard)
- Other hazardous tasks

The trainee should be able to describe benefits and limitations of the permit to work system.

### **13.2.3 Explains the practical benefits of appropriate drills prior to commencing repair work**

The trainee should be able to explain the practical advantages of appropriate drills being carried out prior to commencing repair work.

### **13.2.4 Explains who coordinates the permit and certification process associated with the repair period**

The trainee should be able to explain who are responsible for the different steps in the permit to work process associated with repairs.

### **13.2.5 Explains the parameters that must be met before declaring a space safe for work**

The trainee should be able to explain the parameters that must be met before declaring a space safe for work, e.g. (but not limited to) cold work, hot work and heavy lifts.

## **13.3 Precautions for hot and cold work**

### **13.3.1 Demonstrates the safeguards before and during hot or cold work in accordance with industry standards and legal requirements**

#### **Cold Work**

Cold Work should not be carried out on any apparatus or wiring, nor should any flame-proof or explosion-proof enclosure be opened, nor the special safety characteristics provided in connection with standard apparatus be impaired, until all electrical power has been cut off from the apparatus or wiring concerned. The electrical power should not be restored until work has been completed and the above safety measures have been fully reinstated. Any such work, including changing of lamps, should only be done by an authorized person.

#### **Hot Work**

For the purpose of repairs, modifications or testing, the use of soldering apparatus or other means involving a flame, fire or heat, and the use of industrial type apparatus, is permitted in a hazardous area within a terminal, provided that the area has first been made safe and certified gas free by an authorized person and is then maintained in that condition as long as the work is in progress. When such Hot Work is considered necessary on a berth where a tanker is alongside or on the berthed tanker, the joint agreement of the Terminal Representative and the Responsible Officer should first be obtained and a Hot Work Permit issued.

It is also permissible to restore voltage to apparatus for testing during a period of repair or alteration, subject to the same conditions.

Before undertaking any Hot Work, reference should be made to ISGOTT Chapter 9.

### **13.3.2 Demonstrates the procedures required to conduct a risk assessment prior to hot or cold work**

A risk assessment should entail a careful examination of what, in the range of operations, could cause harm, with a view to deciding whether the precautions are adequate, or whether more should be done to minimize accidents and ill health on board ships.

The risk assessment should first establish the hazards that are present at the place of work and then identify the significant risks arising out of the work activity. The assessment should take into account any existing precautions to control the risk, such as permits to work, restricted access, use of warning signs, agreed procedures and personal protective equipment.

The type of questions that should be answered when carrying out a risk assessment is as follows:

- What can go wrong?

Identification of the hazards and accident scenarios as well as identification of potential, causes and outcomes.

- How bad and how likely?

Evaluation of the risk factors.

- Can matters be improved?

Identification of risk control options to reduce the identified risks.

- What is the effort involved and how much better would the result be?

Determination of the benefit and effectiveness of each risk control option.

- What action should be taken?

Identification of the appropriate course of action to deliver a safe activity based on the hazards, their associated risks and the effectiveness of alternative risk control options.

In summary, the risk assessment should ensure that protective and precautionary measures are taken which will reduce the risks associated with a task to a level that is considered to be as low as reasonably practicable (ALARP).

### **13.3.3 Explains how hot work is to be strictly controlled and governed by vessel's SMS procedure**

The SMS should include adequate guidance on the control of hot work and should be robust enough to ensure compliance. Absence of guidance should be regarded as prohibition rather than approval (IMO MSC/Circ. 1084).

### **13.3.5 Explains that the parameters that must be met before declaring a space safe for cold or hot work**

ISGOTT Chapters 9.4 Hot work and 4.4.5.2 Cold Work should be observed.

## **13.4 Precautions for electrical safety**

All maintenance work on electrical equipment should be undertaken under the control of a permit or an equivalent safety management system, with procedures that ensure that electrical and mechanical isolations are effectively managed.

The use of mechanical lock-off devices and safety tags is strongly recommended.

#### **13.4.1 Demonstrates the safeguards for electrical safety in accordance with industry standards and legal requirements**

The trainee should be able to demonstrate safeguards for electrical safety in accordance with industry standards and legal requirements.

#### **13.4.2 Demonstrates the procedures required to conduct a risk assessment for electrical safety**

The trainee should be able to demonstrate the procedures required to conduct a risk assessment for electrical safety.

#### **13.4.3 Explains how electrical safety is to be strictly controlled and governed by vessel's SMS procedure**

The trainee should be able to explain how electrical safety is strictly controlled and governed by a vessel's SMS procedures, including, but not limited to, permit to work procedures, safe zones, types of equipment etc.

#### **13.4.4 Explains the parameters that must be met before electrical safety can be declared**

The trainee should be able to explain the parameters that must be met before electrical safety can be declared, including but not limited to markings, safe zones, maintenance etc.

#### **13.4.5 Explains the consequences of incorrect maintenance procedures regarding explosion-proof or intrinsically safe electrical equipment**

The trainee should be able to explain the consequences of incorrect maintenance procedures regarding explosion-proof or intrinsically safe electrical equipment.

### **13.5 Use of appropriate Personal Protective Equipment (PPE)**

#### **13.5.1 Explain the industry standards and legal requirements for the use of personal protective equipment**

Protective clothing and equipment should be worn by all personnel engaged in operations on board and ashore.

The trainee should be able to explain the industry standards and legal requirements for the use of PPE.

## **14.0 KNOWLEDGE AND UNDERSTANDING OF OIL TANKER EMERGENCY AND EMERGENCY PROCEDURES:**

### **14.1 Ship emergency response plans**

The trainee should understand that the most important and critical elements of every emergency plan are the organization and resources necessary to support it. The plan will only be effective if careful consideration has been given to these elements in its preparation so that it will fully meet the requirements of the individual oil tanker. It will be necessary to:

- Analyse probable emergency scenarios and identify potential problems.
- Agree on the best practical approach to respond to the scenarios and to resolve identified problems.
- Agree on an organization with the necessary resources to execute the plan efficiently.

The plan should be reviewed and updated on a regular basis to ensure that it reflects any changes within the current best practice and any key lessons from emergency exercises/previous emergencies

Explains that there are various methods for rigging emergency towing-off pennants currently in use. Some terminals may require a particular method to be used and the ship should be advised accordingly.

### **Cargo operations emergency shutdown**

An emergency shutdown procedure, and alarm, should be agreed between the ship and the terminal and recorded on an appropriate form.

The agreement should designate those circumstances in which operations must be stopped immediately.

Due regard should be given to the possible dangers of a pressure surge associated with any emergency shutdown procedure

### **Actions to be taken in the event of failure of systems or services essential to cargo**

The Master and other officers should consider what they would do in the event of failure of systems or services essential to cargo. They will not be able to foresee in detail what might occur in all such emergencies, but good advance planning will result in quicker and better decisions and a well-organized reaction to the situation.

The following information should be readily available:

- Type of cargo, amount and disposition.
- Location of other hazardous substances.
- General arrangement plan.
- Stability information.
- Fire-fighting equipment plans.



## **Describes Action to be taken on Failure of the Inert Gas System**

All personnel in charge of cargo operations are aware that, in the case of failure of the inert gas plant, discharge operations should cease and the terminal be advised. In the case of failure of the IG plant, the cargo discharge, de-ballasting and tank cleaning operations should cease and the terminal be advised.

It should be emphasized here that national and local regulations may require the failure of an inert gas system to be reported to the harbour authority, terminal operator and to the port and flag state administrations.

## **Demonstrates an enclosed space rescue with all relevant rescue equipment.**

A realistic rescue drill should be carried out in a serious manner.

## **Use of a Safety Data Sheet (SDS)**

Display an SDS or give trainees copies of the sheets and explain the contents as: A Safety Data Sheet (SDS) is designed to provide both ships personnel with the proper procedures for handling or working with a particular substance. SDS's include information such as physical data (melting point, boiling point, flash point etc.), toxicity, health effects, first aid, reactivity, storage, disposal, protective equipment, and spill/leak procedures. These are of particular use if a spill or other accident occurs and is considered very useful when making the stowage plan.

## **15 Actions to be taken following collision, grounding, or spillage**

### **15.3 Explains standard initial and follow up actions to be taken subsequent to a collision**

Inform Master. Raise General Emergency Alarm (Internal/External). If possible announce on public address system. Inform the traffic in vicinity on VHF Channel 16/DSC S-VDR/ VDR - Data backed up and kept prepared for further recording as per Ship specific procedure. Check Angle of Contact. Switch on deck lighting & display appropriate nav. lights/ shapes. Ascertain extent of damages. Check for Pollution around the vessel. Initiate damage control measures. Update Vessel's position to radio room/GMDSS Console.

\* NOTE DOWN THE FOLLOWING: Time of Collision. Own vessel's course & speed at the time of collision. Own vessel's position at the time of collision (by what means). Mark Course Recorder trace for actual time of collision. \* Mark Engine Data logger with date & time of collision. If own vessel is not in an immediate danger of sinking, offer to render/render assistance to other vessel.

ENGINE TEAM Prepare engines as required by bridge. Check condition of Machinery & hull damage in E/R. Check Propeller/Rudder/Steering for damage. Prepare pumps to pump out sea water from E/R or cargo spaces. Inspect Piping/Valves/Equipment for any ingress of water. Shut valves if required.

EMERGENCY TEAM Check for hull or any structural damage Sound all hold bilges, cargo tanks including ballast & fuel oil tanks to check ingress of water. Positive air

pressure from any sounding pipe will indicate breach of that compartment. Check extent of damage and ascertain rate of flooding (tons/second) by following formula:  $3 \times \text{Area of hole in sq m} \times \text{Sq. root of (depth of hole in metres below sea level.)}$ .  $=3A\sqrt{h}$  If area of hole is halved then rate of flooding will also be halved. Therefore any makeshift plugging is better than nothing Start pumping out immediately to list/trim the vessel to bring the hole above water line.

Support Team Close all water tight doors and fire doors. Check all compartments are shut. Check for Fire & prepare all fire-fighting Equipment. Refer appropriate section emergency response for "Fire" Prepare lifeboats for launching. Remove anchor lashings.

MEDICAL TEAM Bring Stretcher & first aid kit to the Emergency headquarters. Assist in preparation of Life boat launching.

### **Follow up Actions**

- Check if any one injured, if yes refer appropriate section for emergency response.
- Inform office after immediate actions for safety have been taken
- Check Stability
- Check for cargo damage
- If there is any pollution as a result of collision refer to Shipboard Oil Pollution Emergency Plan (SOPEP), SMPEP, VRP and any State Plan, or other National Plan.
- Monitor prevailing weather/sea conditions and visibility.

### **15.4 Explains standard initial and follow up actions to be taken subsequent to a grounding**

#### ***Bridge Team Action Taken***

Stop Main Engines.

Sound General Emergency Alarm (Internal & External)

Call Master.

Inform Engine Room to change to high sea suction & check for damages.

Display appropriate Lights & Shapes as per Colregs.

Make appropriate sound signals.

S-VDR/ VDR - Data backed up and kept prepared for further recording as per Ship specific procedure.

Switch On deck lighting.

Prepare Urgency Message & inform nearest coast State.

Inform the traffic around on VHF Channel 16.

Check for Pollution around the vessel.

Initiate damage control measures

Check for Timing of High tide & Range. Check direction of current.

Consider if vessel can be lightened by pumping out any Ballast/FW or in extreme cases Cargo.

Consider possibility to change trim by internal transfer.

Use Engines to refloat after assessing the situation as per reports from other teams.  
Avoid too many astern movements especially if the nature of bottom is such that, the ship is likely to dig in deeper into the seabed. Preferably wait for high tide.  
Update Vessel's position to radio room/GMDSS Console

\* Note down

Time of grounding  
Vessel's course & speed at the time of grounding  
Vessel's position at the time of grounding

\* Check Echo sounder sounding Fore & aft. Compare with charted sounding.

\* Mark

Course recorder Trace for actual time of grounding  
Engine data logger with data & time of grounding

Keep a record of Time, Name of Party contacted. How contacted (Tlx/Fax/Tel) & brief details of all communications.

Engine team Action Taken

Check condition of Machinery & hull damage in E/R.

Change over to High sea suction.

Check Tail shaft for Oil Loss.

Check Propeller/Rudder/steering for damage.

Prepare pumps to pump sea water from E/R or Holds.

Inspect Piping/Valves/Equipment for any ingress of water. Shut valves as required.

Turn M/E on turning gear & hammer test foundation bolts.

Check for Hull damage.

\* Sound all hold bilges, cargo tanks including ballast & fuel oil tanks to check ingress of water. Positive air pressure from any sounding pipe will indicate breach of that compartment.

\* Check overside sounding all around the vessel by the hand lead line. Note down height of tide.

\* Check Draft Fore & Aft. after the grounding. Check draft at regular intervals.

Check actual sea bottom condition.

Inform distribution of cargo weights to Bridge.

Inform original and current Ballast/FW distribution to Bridge.

Inform original and current Bunker distribution on Bridge.

Check for any movement/loss of cargo or any damage.

Close all water tight doors. Check all compartments are shut.

Check for "Fire" and prepare all firefighting Equipment.

Remove anchor lashings.

Prepare lifeboats for launching.

### **Follow up Actions**

- Inform office after immediate actions for safety have been taken.
- Monitor prevailing weather/sea conditions and visibility
- Check weather forecasts

- Consider risk of heavy waves that might cause slamming Check timing of high tide & range. Check direction of current
- Consider if vessel can be lightened, in extreme cases, by lightening cargo. Jettisoning cargo may be considered if ship is in serious danger.
- Consider if additional ballast is required for preventing vessel from going further aground
- Inspect all fuel/Steam lines for damages at regular intervals up to 3 days after grounding
- **Check M/E crankshaft deflections (prior using engine to re-float vessel) compare with normal readings.**
- If there is any pollution as a result of grounding refer to SOPEP/SMPEP/VRP/State Plan/National Plan
- Consider whether assistance regarding structural condition is required. If yes, send report in the Classification Society format or in the format given in SOPEP if the ship is not entered in an emergency response arrangement such as SERS or RRDA.
- Note down vessel's Draft Fore & aft. before and after the grounding.

## **Evidence Collection**

### **Grounding position**

- Description of the part of the ship aground
- Description of the area of the seabed where the grounding took place
- Course (charted course, steered course, gyro and magnetic compass) at the time of the grounding
- Speed, propeller revolutions or propeller pitch of the ship at the time of the grounding
- Rudder position at the time of the grounding
- Any alteration to course and/or speed immediately before the grounding and the exact time of such alteration
- Any communications including orders given to the engine room
- Any communications exchanged between the ship and shore radio stations or traffic control centres.

If under pilotage any communications between the pilot and the ship's command including helmsman prior to the grounding

### **15.5 Explains standard initial and follow up actions to be taken subsequent to a spillage**

#### **BRIDGE TEAM**

Note down ships position Date/Time (UTC).

Alter course/reduce speed if harmful substances are released due to heavy weather. Evaluate hazards associated with the cargo for personnel, as well as risk of fire/explosion etc.

Raise alarm/muster crew if necessary.  
Inform office.

Inform nearest coastal state.

(Refer Annex "Reporting procedure involving dangerous goods harmful substances and/or marine pollutants". Inform P & I, if in port.).

## EMERGENCY TEAM

### ***Action Taken***

Take appropriate action to reduce or stop further release of harmful substance Find the cause of release of harmful substance

Estimate Quantity released Refer

1. "Emergency Schedule" (IMDG Code)
2. Dangerous cargo Manifest
3. Stowage Plan for details

Check Following:

- a) Total Quantity Released
- b) Proper Shipping Name
- c) UN number/Class
- d) Category of Marine Pollutant
- e) Additional Information on handling on board
- f) Port of loading/Discharge

## **OTHER TEAMS TO ASSIST AS INSTRUCTED**

Follow Up Actions

If any spillage on deck, have it cleaned if safe to do so, based on information from IMDG Code & Dangerous Cargo Manifest

### **15.6 Explains the importance of evidence collecting and emergency reporting requirements**

When the ship is involved in an incident which results in the discharge or probable discharge of oil, the Master is obliged under the terms of MARPOL 73/ 78 to report details of the incident, without delay, to the nearest Coastal State by means of the fastest telecommunication channels available.

The intent of these requirements are to ensure that Coastal States are informed, without delay, of any incident giving rise to oil pollution, or threat of oil pollution, of the marine environment, as well as of assistance and salvage measures, so that appropriate action may be taken.

Without interfering with ship owners' liability, some coastal states consider that it is their responsibility to define techniques and means to be taken against an oil pollution incident and approve such operations which might cause further pollution, i.e. lightening. States are in general entitled to do so under the International Convention relating to Intervention on the High Seas in Cases of Oil Pollution Casualties, 1969.

Ships' Masters have an important role in the collection of evidence that will help the insurance agencies evaluate the damage and establish liability.

Evidence should be collected, recorded and preserved. Memories fade. It is therefore imperative to make notes on how the incident occurred as soon as possible after the event.

The basic rules to remember in case of any accident or incident on board your ship are:

- Keep your owner and manager informed;
- Notify the local P&I correspondent;
- Investigate the accident or incident as soon as practical;
- Collect and retain any evidence or documentation relating to the accident;
- Ask witnesses to write down what happened, and keep detailed records of all relevant facts;
- Take photographs wherever possible.

## **16.0 KNOWLEDGE OF MEDICAL FIRST AID PROCEDURES ON BOARD OIL TANKERS**

16.8.1 Explains the actions taken in a medical emergency and how they conform to current recognized first aid practice and international guidelines

This training may be done by a master mariner or preferably a medical practitioner. The trainer should emphasize the use of the medical first aid guide and demonstrate the actions to take when various medical emergencies occur as explained in the MFAG.

The International Medical Guide for Ships is easy to read and understand. It tells you how to diagnose, treat and prevent health problems in seafarers, with a focus on the first 48 hours after injury.

It should be kept in the ship's medicine chest, and you should familiarize yourself with the content before a medical emergency occurs. This way, when there is a case of illness or injury on board, you can immediately turn to emergency medical advice on the topic at hand.

Chapters 1–24 follow this structure:

- general description of symptom or disease
- explanatory notes when necessary
- signs and symptoms
- key questions to ask
- what to do
- what not to do.

These chapters also contain information on how to prevent specific injuries or illness, by action that can be taken on board. General prevention and health promotion is covered in Chapter 30.

Since immediate response is essential for life-threatening conditions, the first 11 chapters cover the principals of first aid, and how to respond to choking, bleeding, shock, pain, injuries, wounds, burns, and poisoning.

Chapter 12 outlines the general principles of physical examination and the necessity of obtaining consent for examination and treatment.

Chapter 25 describes how to use external assistance and seek medical advice by radio, and includes a general recommendation on the use of digital photographs to assist in obtaining diagnostic and treatment advice in this context. It includes a form

for obtaining and transcribing such advice.

Chapter 32 contains the relevant articles of the revised International Health Regulations (2005). Chapter 33 lists the necessary medicines for stocking the ship's medicine chest, including those which should only be used with radio medical advice. This list is consistent with WHO's essential drugs list, and provides indications, doses, and specific precautions for each entry.

Annex A contains medical referral and evacuation forms which should be copied and stored with the medical supplies

This guide is designed to be used in conjunction with the most recent versions of the *Guide to Ship Sanitation*, and the IMO's *Medical First Aid Guide and Emergency Procedures for Ships*

*Carrying Dangerous Goods*.

Importance is to be given with respect to the effects of Petroleum products as stated in the MFAG as:

Petroleum products are generally not absorbed from the bowel: poisoning results from lung exposure.

- Asphalt, motor oil and axle grease are not toxic.
- Petrol (gasoline), turpentine, kerosene and cigarette lighter fluid cause lung inflammation if they enter the lungs.
- Petrol (gasoline), propane, butane, benzene and toluene form vapours easily, pass
- through the lungs into the blood, and are then carried to the brain

### **Signs and symptoms**

#### **■ In cases of lung inflammation:**

- breathlessness
- cough, that may be dry or may produce blood-stained sputum.

#### **■ If the brain is affected:**

- drowsiness
- confusion
- staggering
- slurred speech.

What to do

■ In cases of exposure to petrol (gasoline), propane, butane, benzene or toluene remove contaminated clothing to prevent further exposure to vapours and have the patient shower with soap for 10 minutes.

■ If there is evidence of lung damage, seek medical advice with a view to evacuation

## **17.0 Understanding of procedures to prevent pollution of the atmosphere and the environment**

17.1 States that any failure or malfunctioning of the equipment (ODME) must be recorded in the oil record book

### **17.2 Controlled operational pollution at sea**

17.2.1 Describes how operations are conducted in accordance with accepted principles and procedures to prevent pollution of the environment

The most important regulations for preventing pollution by oil from ships are contained in Annex I of the International Convention for the Prevention of Pollution from Ships, 1973, as modified by the Protocol of 1978 relating thereto (MARPOL), The International Convention for the Safety of Life at Sea (SOLAS), 1974 also includes special requirements for tankers.

Ship-related operational discharges of oil include the discharge of bilge water from machinery spaces, fuel oil sludge, and oily ballast water from fuel tanks. Also other commercial vessels than tankers contribute operational discharges of oil from machinery spaces to the sea. Cargo-related operational discharges from tankers include the discharge of tank-washing residues and oily ballast water.

Any discharge into the sea of oil or oily mixtures from the cargo area of an oil tanker, shall be prohibited except when all the following conditions are satisfied:

- .1 the tanker is not within a special area;
- .2 the tanker is more than 50 nautical miles from the nearest land;
- .3 the tanker is proceeding en route;
- .4 the instantaneous rate of discharge of oil content does not exceed 30 litres per nautical mile;
- .5 the total quantity of oil discharged into the sea does not exceed for **tankers delivered on or before 31 December 1979**, as defined in regulation 1.28.1, 1/15,000 of the total quantity of the particular cargo of which the residue formed a part, and for **tankers delivered after 31 December 1979**, as defined in regulation 1.28.2, 1/30,000 of the total quantity of the particular cargo of which the residue formed a part;
- .6 the tanker has in operation an oil discharge monitoring and control system and a slop tank arrangement

**Bio-fuel blends** containing 75% or more of petroleum oil will be subject to MARPOL Annex I. Unless the ODME (Oil Discharge Monitoring Equipment) is approved for the mixture being transported, all tank washings are required to be delivered ashore. After 1 January 2016, only Annex I bio-fuel blends for which the ODME is certified may be carried.

Before international regulations were introduced to prevent oil pollution from ships, the normal practice for oil tankers was to wash out the cargo tanks with water and then pump the resulting mixture of oil and water into the sea. Also, oil cargo or fuel tanks were used for ballast water and, consequently, oil was discharged into the sea when tankers flushed out the oil-contaminated ballast water to replace it with new oil. Following are some controls now in place for minimizing pollution to attain standards set by various regulations:



- **Crude oil washing systems (COW)** means that the cargo tanks, where tankers carry the oil they transport, are cleaned by means of high-pressure flushing with crude oil ("oil to remove oil") or crude oil plus water. This reduces the quantity of oil remaining on board after discharge. The residues from such tank washing are pumped into slop tanks and handled by either pumping out to a shore reception facility or loading on top.
- **Segregated ballast tanks (SBT)**. Ballast water is taken on board to maintain stability, such as when a vessel is sailing empty to pick up cargo or after having unloaded cargo. Ballast water contained in segregated ballast tanks never come into contact with either cargo oil or fuel oil.
- **Clean ballast tanks**. To have dedicated clean ballast tanks (DCBT) means that product tankers cargo tanks are dedicated to carry ballast water only.
- **Heavy Weather ballast**. In exceptional weather master may consider heavy weather ballast in cargo tanks to keep the vessel safe, this may be done provided the tanks are crude oil washed prior to taking ballast. Such ballast is to be treated as dirty ballast and tanks subsequently washed with water after the dirty ballast has been discharged at sea through the ODMCS and residues from such tank washing are transferred into slop tanks and discharged to a reception facility in port or "Load on Top" procedure followed.. The tanks are then ballasted with Clean ballast also called Arrival ballast which can be discharged in accordance with MARPOL Regulations.
- **Operational oil separation and filtering equipment with an automatic stopping device**. Bilge water is produced when the machinery spaces of a vessel are cleaned. Leaking cooling water often becomes contaminated with fuel oils and lubricant oils. Vessels in operation produce oil-contaminated bilge water to a variable extent. With this equipment fitted on board to comply with Marpol regulations, dirty bilge water can be processed in a way that separates most of the oil from the water before it is discharged into the sea. If the oil content exceeds the limit, the discharge is automatically stopped (bilge alarm).

In a sea area with Special Area status under the international MARPOL Convention Annex I (so far, only the Mediterranean Sea area, the Baltic Sea area, the Red Sea area, the Gulf of Aden area, the Antarctic area, and the North West European waters), it is altogether forbidden for oil tankers to discharge cargo oil, oily sludge and oil-contaminated residues from tank washing, or heavily oil-contaminated ballast water. All oily wastes (mixtures) must be kept on board and stored in slop tanks until the vessel reaches a reception facility in port. Furthermore, it is not allowed to discharge machinery bilge water unless it has been properly cleaned and contains no more than 15 ppm of oil and other conditions required by Marpol are met.

Most sea areas are not Special Areas, but in accordance with international regulations under MARPOL, attempts are nevertheless made to make large oil tankers and product carriers have equipment for crude oil washing and segregated ballast tanks. According to MARPOL Annex I, adopted in 1978, all new crude oil tankers of 20,000 dwt and above, and all new product carriers (30,000 dwt and above), must have SBT. Existing tankers over 40,000 dwt must be fitted either with SBT or with COW systems. For an interim period it was also allowed for some tankers to use CBT.

All oil tankers and other large vessels must be fitted with the equipment described above for machinery bilge water cleaning. However, it must be emphasized that bilge water could also contain traces of detergents used in the cleaning process. When mixed, the residues of oil and detergents form a stable emulsion with another density than oil. This sometimes milk-like but highly oil-contaminated mixture is not always "recognized" by the separation and filtering equipment, and thus discharged into the sea. Such detergents are not allowed to be used.

### **Accepted principles and procedures to prevent pollution of the environment**

1) Watch the Sea surface around the Vessel

2) The Gangway Watch stander and cargo operation watch stander shall periodically monitor the surface of outboard sea to check for oil leakage, and to try to detect such oil leakage (if any) early. He shall also monitor the emission from the funnel stacks (excessive soot or sparks) and report any abnormality to the duty officer.

3) If floating oil is observed on the surface of the sea in the vicinity of the vessel, it shall be reported immediately to the officer on duty or the Chief Officer (irrespective of whether the oil is originating from own vessel or not).

4) The officer on duty shall allocate crew for periodic monitoring on deck and associated spaces to check for leakages. Also to detect any irregularity onboard and outboard the vessel.

5) The officer on duty shall have the crew patrol or monitor the surface of the sea near the following places or outfit as required:

Sea-chest (Cargo & Ballast)

Overboard discharges,

Floating hose if applicable

Stern tube,

Shore connection, and

Near SPM & SBM if applicable.

6) The company designated checklists should be used to ensure proper compliance of the above.

### **Action by Duty Officer**

If oil is observed on the water in the vicinity of the vessel and there is reason to suspect that the oil is originating from the vessel, all cargo transfer operation shall be suspended, and the Master shall immediately be notified.

Appropriate notification in accordance with SOPEP/OPA90 and shall be executed. Immediate action should be taken to reduce such outflow (e.g. Depressurizing the system, Adjusting the level, etc.).

### **Plugging Deck Scupper Plugs**

Suitable scupper plugs shall be used the expansion-type oil resistant rubber-mechanical scupper plug.

Oil Coaming (e.g. save-all trays to air pipes serving oil tanks, mooring winch save-alls, etc.) shall be effectively plugged, and the ship specific Oil Coaming Plug Checklist shall be prepared and used for confirming it.

If rainwater collects on the aft main deck, the rainwater may be released through the aftermost scuppers after carefully checking and confirming that No Oil water or Traces of Oily sheen is mixed with the rainwater.

Such draining in port shall be carried out only after Loading Masters permission, bearing in mind the above.

Oil absorbent pads should be used as a precautionary measure, when draining rain water in port. Personnel shall continuously attend such operation and after completion, confirm with the COC the final status of scupper.

However, if collected water is contaminated with oil, or if terminal refuses to let the water through the scupper, then suitable means such as oil catcher (oil absorbent pads) to clear such oily sheen could be used to the satisfaction of the terminal representative.

### **Working system and preparation**

The Master is responsible for the prevention of marine pollution. The Chief Officer is responsible and shall comply with all instructions as laid out in SMS procedures for all cargo oil transfer operations and ballast operations. He shall supervise all such activities carried out by the Junior Deck Officers and Deck Crew.

---

### **Planning for Cargo Oil Operations**

Prior to commencement of any cargo oil operation the Chief Officer shall prepare a detailed plan & the same to be approved by Master.

The Cargo oil operations plan shall be prepared in writing, and posted conspicuously in the Cargo Control Room. It shall be made available to all officers and crew directly involved in the cargo oil transfer operations. The plan shall include at least the following operations:

Loading, Discharging and Transfer of cargo oil,  
Crude Oil Washing,  
Tank cleaning, Purging and / or Gas-freeing,  
Ballasting and De-ballasting,  
Decanting of the slop tank, and  
Delivery of Slops, Sludge and Cargo Residues to shore facility.

### **Pre-safety meeting**

The Chief Officer shall conduct "Pre cargo operation safety meeting" with all concerned. The plan shall be read out to the attending crew the duty officers involved to ensure good understanding by all such personnel,

The following shall be addressed, as a minimum:

Special features and characteristics of the cargo, addressing any precautions to be observed, i.e. high H<sub>2</sub>S content, high viscosity, high vapor pressure, initial monitoring of loaded heated cargo temperatures, etc.

Procedures and arrangements for starting and stopping loading or discharging operations, crude oil washing, and ballast operations.

Communication between the cargo control room, pump room and on-deck.

Monitoring requirements for the Maximum Allowable Loading Rates, topping off rates / Discharging Rates (grade-wise)

Monitoring and maintaining the maximum allowable manifold pressure during discharge operations.

Special conditions at the loading/discharging terminal (e.g. moorings, draft and trim limits, monitoring manifold movement restrictions including height limitations, river and tidal currents, etc.

Specific duties distribution for Junior Officers and crew.

Procedures for emergency situations and communication.

### **Effective Communication**

Effective means of communication shall be established between the cargo control room, on deck watch standers and shore terminal operators.

Fixed and portable communication devices used during cargo oil transfer operations shall be tested prior to commencement of below operations:

Loading, Unloading and transfer of oil

Crude oil Washing

Tank Cleaning and Gas Freeing

Ballasting and De-ballasting

Drainage of the slop tank and

Delivery of Slop / Sludge

### **Promote techniques of Hazard Prediction Training**

To prevent mistakes caused by human, which make up the greater part of causes of accidents, matters that require attention shall be discussed before the start of work. The items for the "One point finger pointing and call method" should be practiced.

### **Preparation of Watch Schedule & PIC of Oil Transfer Operations**

The Chief Officer shall prepare and post a watch schedule detailing the person in charge for the duration of the planned cargo oil operation.

This schedule shall detail the working arrangements, duty shifts and contact details. Leaders of shifts should also be mentioned. The schedule shall include additional support staff and include the person in charge of cargo transfer operations.

### **Have a complete meeting beforehand with terminal**

The Chief Officer shall complete the company's designated checklists and conduct a Pre-transfer meeting with shore facility representative(s) to cover all aspects of the proposed operations.

The following items shall be discussed during the meeting:

- Specifications, temperatures (if applicable) and quantity of cargo oil. Including peculiar hazards / precautions needed to be followed.
- Maximum oil transfer rate, and maximum manifold pressure.
- Any shore / terminal / berth restrictions, including loading arm restrictions and any specific preventive measures or requirements to be adopted to avoid accidents.
- Any safety regulations of the terminal (Latest Terminal handbook, etc.)
- Any particular vessel requirements
- In case of discharging, Shore receiving tanks details and distance from ship, Crude Oil Washing Plan details and terminal procedures/restriction.
- Any other related circumstances and procedures requiring special attention.
- Stoppage / disconnection criteria in normal and emergency situations
- Procedures for emergency situations and means of communication.

For above 'Procedures for emergency situations and means of communication', the reporting method for the following cases shall be discussed and mutually agreed upon:

Emergency Stop Procedures

Standby

Commencement of transferring oil

Slow down,

Temporary stoppage and final Stoppage.

Prior to loading, the "Ship-Shore Cargo Information Exchange at Loading Ports"

The vessel should send and exchange such required information (details which can be obtained from the Port Guide or local agent) by national and regional regulations, well in advance of her arrival, which may be required in the form of a check list.

### **Cargo Oil Transfer Check Lists**

The Chief Officer, after confirmation, shall affix his signature on the related checklist. The Master, shall then sign on the completed checklist.

"Tanker Loading Checklist" (Including Pre Arrival Checks and Tests for Loading Port)

"Tanker Discharging Checklist", (Including attached Annex A-Pre Arrival Checks and Tests for Discharging Port)

"Crude Oil Washing Checklist".

"Crude Oil Washing Record"

"Ship-Shore Cargo Information Exchange at Loading Ports"

"Ship / Shore Safety Checklist"

"Ship to Ship Transfer Checklist", as required.

"Tank Cleaning, Purging and Gas Free Checklist"

### **Ship / Shore Safety Checklist**

The above checklist shall be completed correctly and signed by both the Chief Officer and the shore terminal representative.

Each shall retain one copy of the check list. For items that need to be periodically verified, suitable intervals shall be decided and entered at the initial stage.

For US Ports, each item of confirmation in the "Declaration of Inspection" needs to be initialed by both parties, prior to commencement of cargo oil transfer operations.

### **Pre Arrival Checks**

The pre-arrival cargo gear and other equipment checks are to be conducted as and details entered into the deck log book.

Tanker Loading Checklist, Tanker Discharging Checklist, Crude Oil Washing Checklist to be completed as required. Ship specific "Checklist for Preparation for Entering Port" and other ship controlled documents should be prepared and approved for use and distributed onboard for efficient compliance.

### **Transfer of Duty in Conscientious Manner**

The deck duty officer shall enter all cargo oil transfer operation activities and other associated activities in the "Tanker Cargo Log Book" and shall transfer the duty to the relieving deck officer after the status of the following activities has been discussed & checked:

- Confirmation of open/closed valves,
- Operational condition of pumps,
- Cargo loading/discharging quantity / rate, and

- Expected time of change-over of tanks.
- Draughts and ship's pose
- Special additional instructions.
- Checking Items marked "R" (Re check) as per Ship-shore check list (ISGOTT).

The deck duty officer shall also relay the status of other ongoing activities related to the oil cargo transfer operation like Ballast operations, tank cleaning, oily water transfers and COW operations.

### **Check Operational Conditions and Training of Crew**

The Master and Chief Engineer shall ensure that the concerned crew are well acquainted with the mechanism and its operation.

They shall also ensure that the equipment and machinery is inspected and maintained in its operational readiness before use.

The Chief Officer is responsible for the training of all crew directly involved in oil cargo transfer operations. He shall train all such personnel to be familiar with the proper operation of all equipment and machinery related to oil cargo transfer operations.

The Chief Officer is also responsible for assuring that the below equipment is inspected and checked for operational condition prior to the commencement of any Cargo Oil Transfer operation.

- Valves.
- Pumps.
- Inert gas system.
- Level gauges.
- High level alarm unit.
- Hydraulic unit.

The manufacturer's instruction manuals should be used.

### **Vapour emissions and Volatile Organic compounds**

The fundamental concept of a vapour emission control system is relatively simple. When tankers are loading at a terminal, the vapours are collected as they are displaced by the incoming cargo or ballast and are transferred ashore by pipeline for treatment or disposal. However, the operational and safety implications are significant because the ship and terminal are connected by a common stream of vapours, thereby introducing into the operation a number of additional hazards which have to be effectively controlled.

Detailed guidance on technical issues associated with vapour emission control and treatment systems is available from a number of sources. IMO has developed international standards for the design, construction and operation of vapour

collection systems on tankers and vapour emission control systems at terminals, and OCIMF has initiated and issued guidance on vapour manifold arrangements (see Bibliography).

It should be noted that Vapour Emission Control Systems (VECS) can serve tankers fitted with inert gas systems and also non-inerted tankers.

A summary of the terminal's VECS should be included in the terminal information booklet.

#### Volatile Organic Compound (VOC) Management Plans

The purpose of the VOC management plan is to ensure that the operation of a tanker, to which regulation 15 of MARPOL Annex VI applies, prevents or minimizes VOC emissions to the extent possible. This applies to tankers carrying crude oil.

Emissions of VOCs can be prevented or minimized by:

- optimizing operational procedures to minimize the release of VOC emissions; and/or
- using devices, equipment, or design changes to prevent or minimize VOC emissions.

To comply with this plan, the loading and carriage of cargoes which generate VOC emissions should be evaluated and procedures written to ensure that the operations of a ship follow best management practices for preventing or minimizing VOC emissions to the extent possible.

If devices, equipment, or design changes are implemented to prevent or minimize VOC emissions, they shall also be incorporated and described in the VOC management plan as appropriate.

While maintaining the safety of the ship, the VOC management plan should encourage and, as appropriate, set forth the following best management practices:

- the loading procedures should take into account potential gas releases due to low pressure and, where possible, the routing of oil from crude oil manifolds into the tanks should be done so as to avoid or minimize excessive throttling and high flow velocity in pipes;
- the ship should define a target operating pressure for the cargo tanks. This pressure should be as high as safely possible and the ship should aim to maintain tanks at this level during the loading and carriage of relevant cargo;
- when venting to reduce tank pressure is required, the decrease in the pressure in the tanks should be as small as possible to maintain the tank pressure as high as possible; The amount of inert gas added should be minimized. Increasing tank pressure by adding inert gas does not prevent VOC release but it may increase venting and therefore increased VOC emissions; and
- when crude oil washing is considered, its effect on VOC emissions should be taken into account. VOC emissions can be reduced by shortening the duration of the washing or by using a closed cycle crude oil washing programme.



## **18.0 KNOWLEDGE AND UNDERSTANDING OF RELEVANT PROVISIONS OF THE INTERNATIONAL CONVENTION FOR THE PREVENTION OF POLLUTION FROM SHIPS (MARPOL), AS AMENDED, AND OTHER RELEVANT IMO INSTRUMENTS, INDUSTRY GUIDELINES AND PORT REGULATIONS AS COMMONLY APPLIED**

The mandate of the International Maritime Organization (IMO), as a United Nations specialized agency, is to promote safe, secure, environmentally sound, efficient and sustainable shipping. This is accomplished by adopting the highest practicable standards of maritime safety and security and prevention and control of pollution from ships, as well as through consideration of the related legal matters and effective implementation of IMO's instruments with a view to their universal and uniform application.

### **Environmental Activities**

Within its environmental mandate, IMO has developed and adopted a range of international instruments to address marine pollution arising from international shipping, which include the:

- International Convention for the Prevention of Pollution from Ships
- International Convention Relating to Intervention on the High Seas in Cases of Oil Pollution Casualties
- International Convention on Oil Pollution Preparedness, Response and Co-operation
- International Convention on Civil Liability for Oil Pollution Damage
- International Convention on the Establishment of an International Fund for Compensation for Oil Pollution Damage
- Convention on the Prevention of Marine Pollution by Dumping of Wastes and Other Matter
- International Convention on the Control of Harmful Anti-fouling Systems on Ships
- International Convention for the Control and Management of Ships' Ballast Water and Sediments

### **18.1 Demonstrates a working knowledge of MARPOL Annex I and the procedures to properly monitor and control compliance**

The trainee should be familiar with how MARPOL Annex I is built up. He/she should be able to find necessary/relevant information in MARPOL Annex I, as per instructions received.

### **18.2 Demonstrates the ability to correctly complete Oil Record Book entries**

The trainee should be able to make correct Oil Record Book (ORB) entries and complete assignments requiring correct ORB-entries

# Appendix 1

## Diagrams for use by the Instructor Print off as handouts or use for OHP transparencies if suitably enlarged

NOTE: The numbering of the figure appended herein is that of the General Learning Objectives (GLO)

e.g. Figure no: 2 (A to G) represents GLO 2.0 Knowledge of pump theory and characteristics, including the types of Cargo Pumps and their safe operations and should be used with their respective Specific learning Objectives (SLO) included in Part "C" and Part "D" respectively.

Diagrams from the IMO Model Course 1.01 - Basic Training For Oil and Chemical Tanker Cargo Operationscourse may also be used.

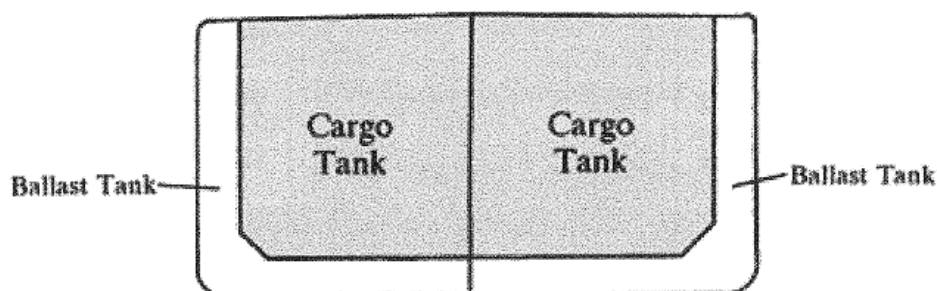

Figure 1 (A) General layout of double hull tanker

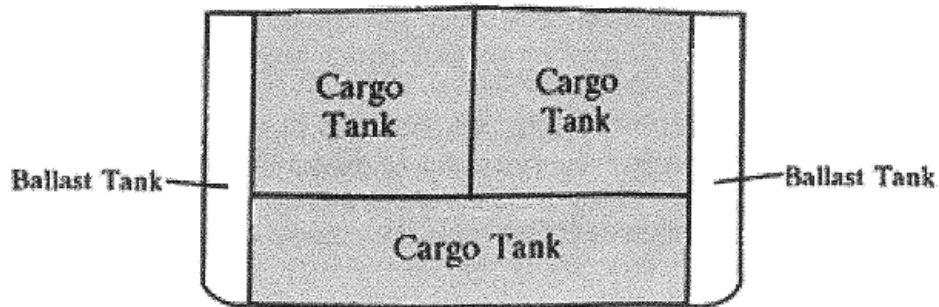

Figure 1 (B) General layout of mid deck tanker

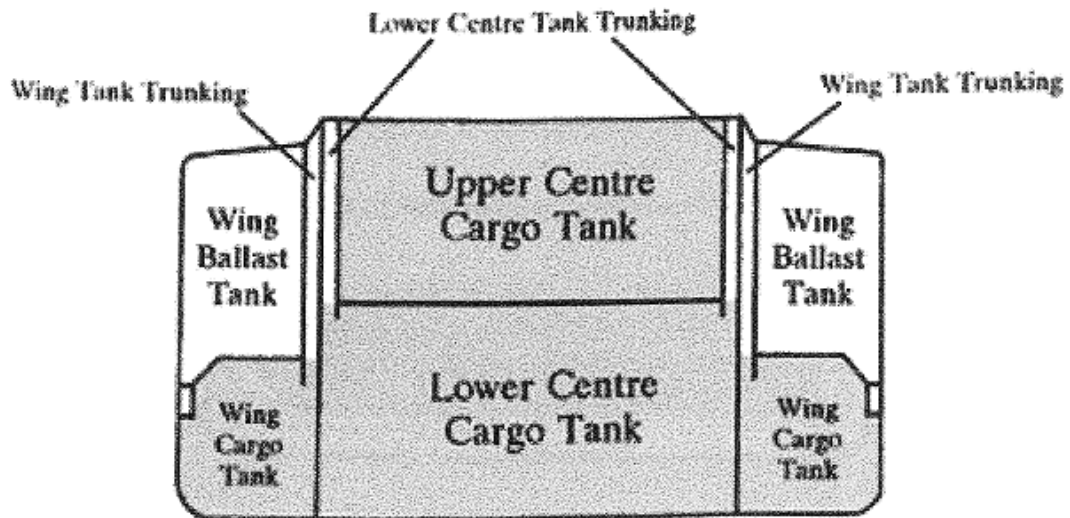
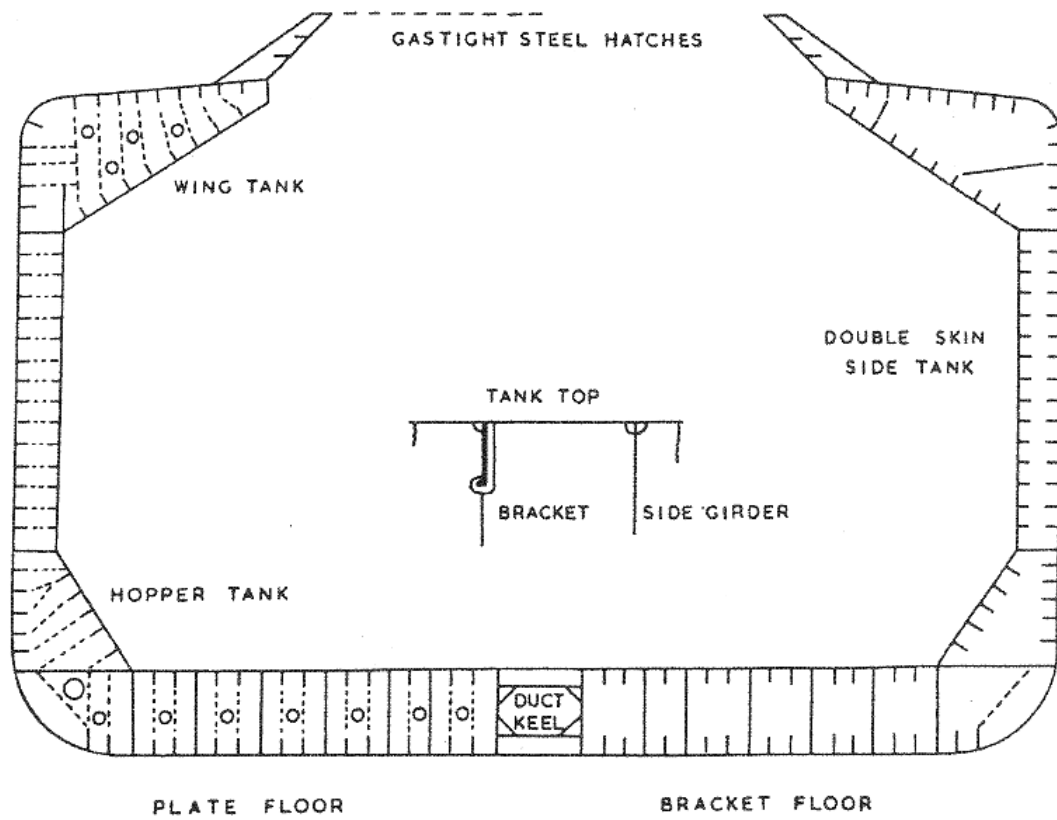
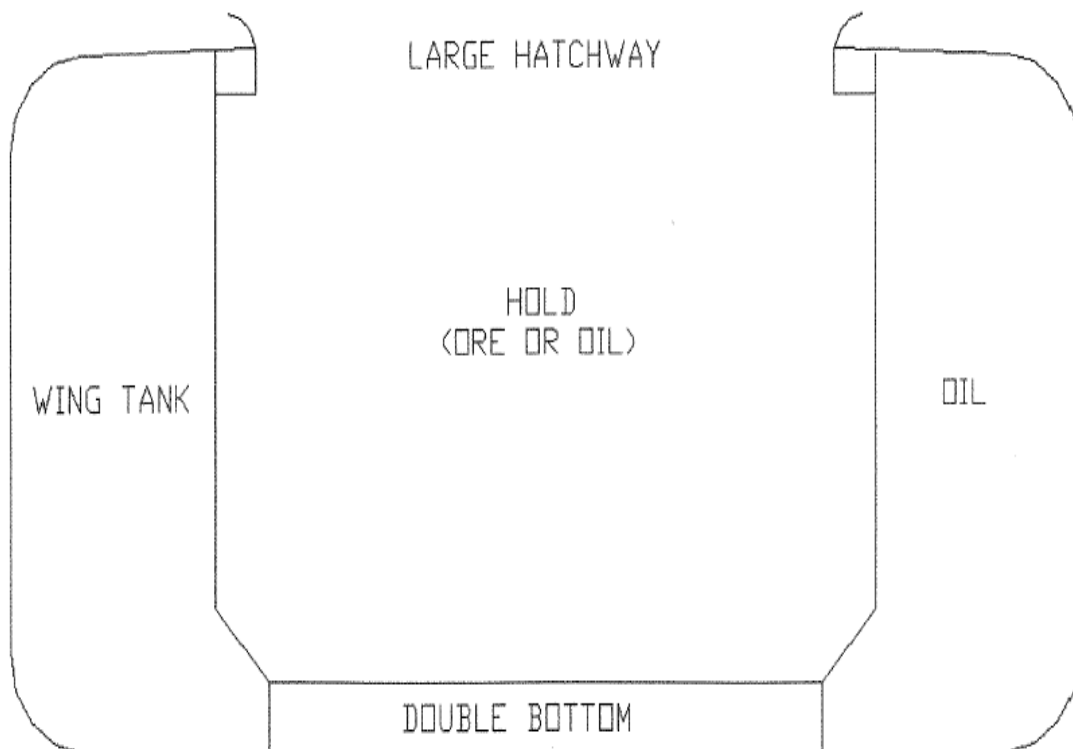

Figure 1 (C) General layout of coulomb Egg tanker



**Figure 1 (D) Oil/bulk/ore (OBO) ship: cross section**



**Figure 1 (E) Oil/ore (O/O) ship: cross section**

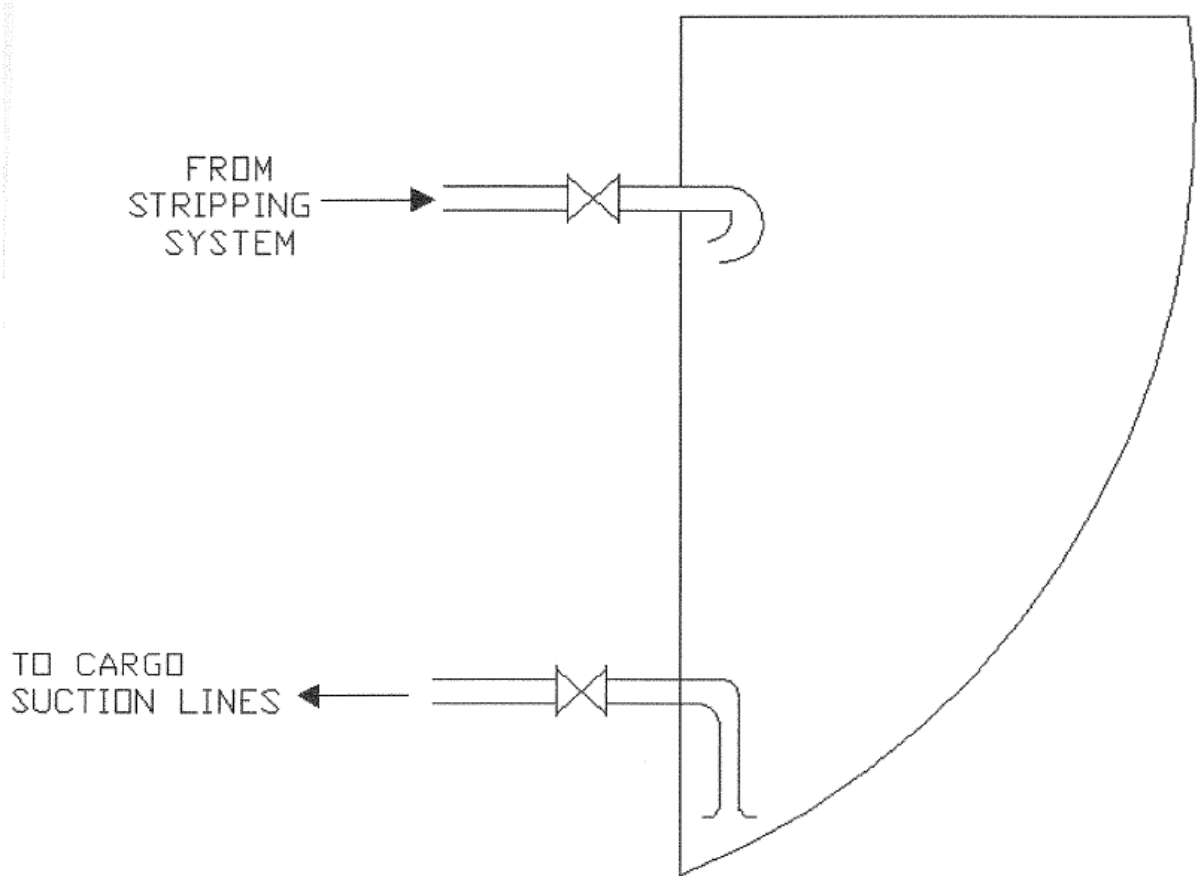

**Figure 1 (F) Slop – tank arrangement**

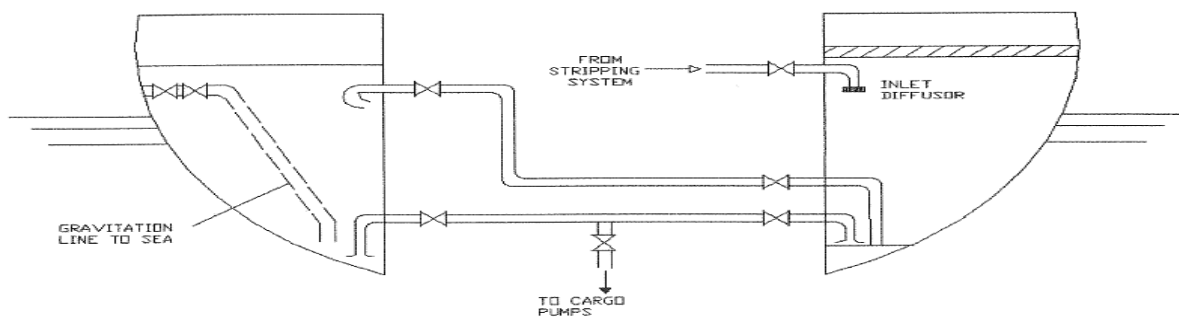

**Figure 1 (G) Efficient slop-tank arrangement**

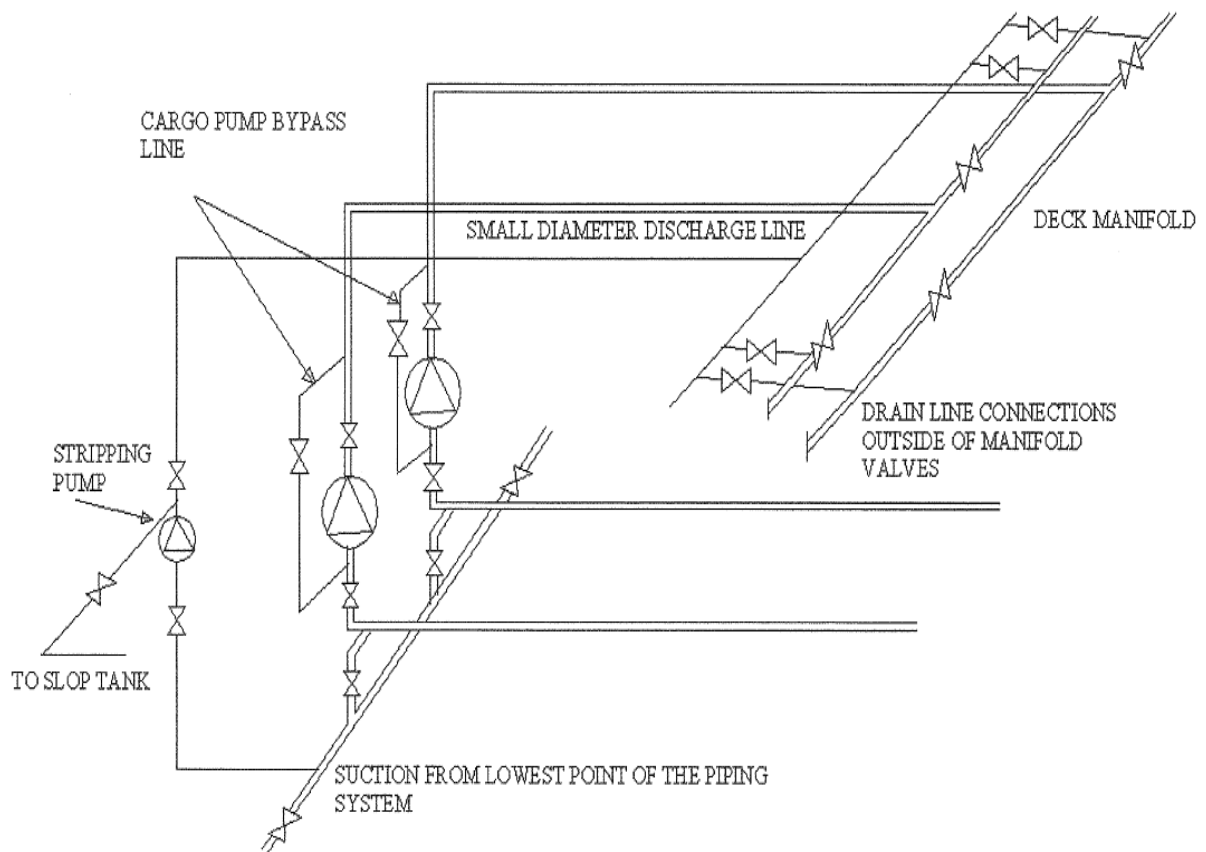

**Figure 1 (H) Pump and line drainage arrangement and "small – diameter" drainage discharge line**

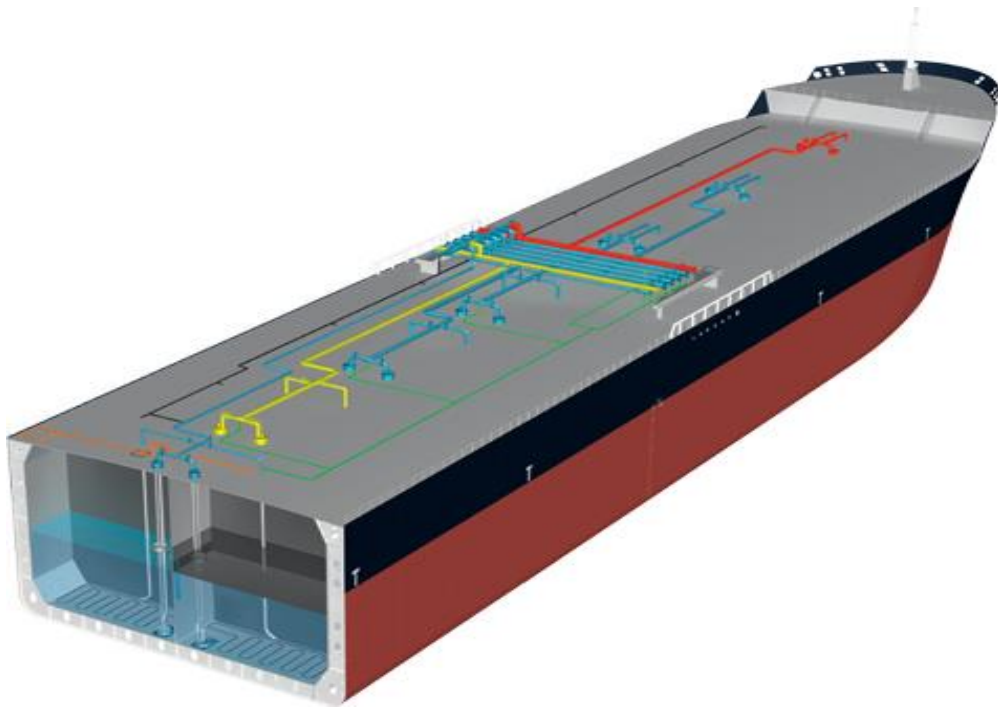

**Figure 1 (I) Deck Pipelines**

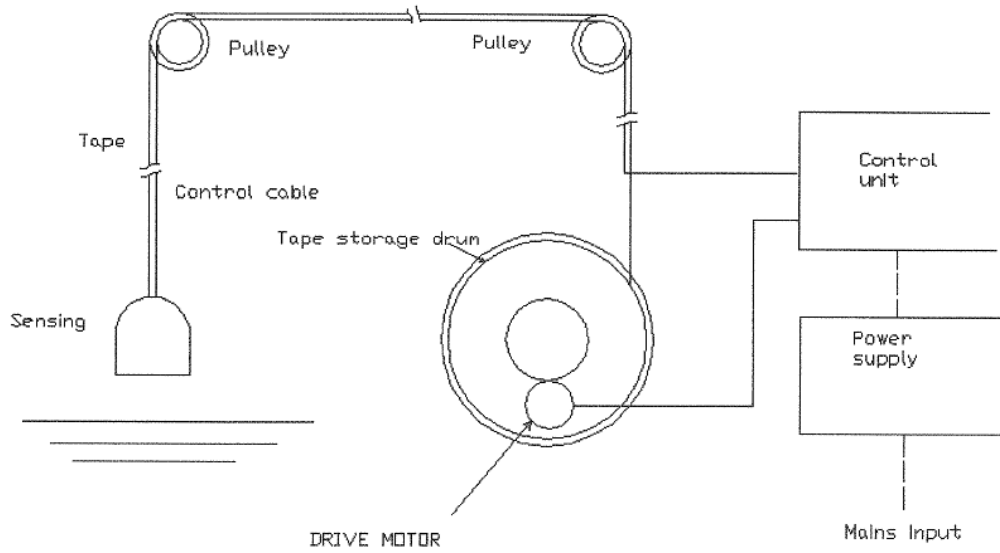

**Figure 1 (J) Electrically powered servo-operated gauge**

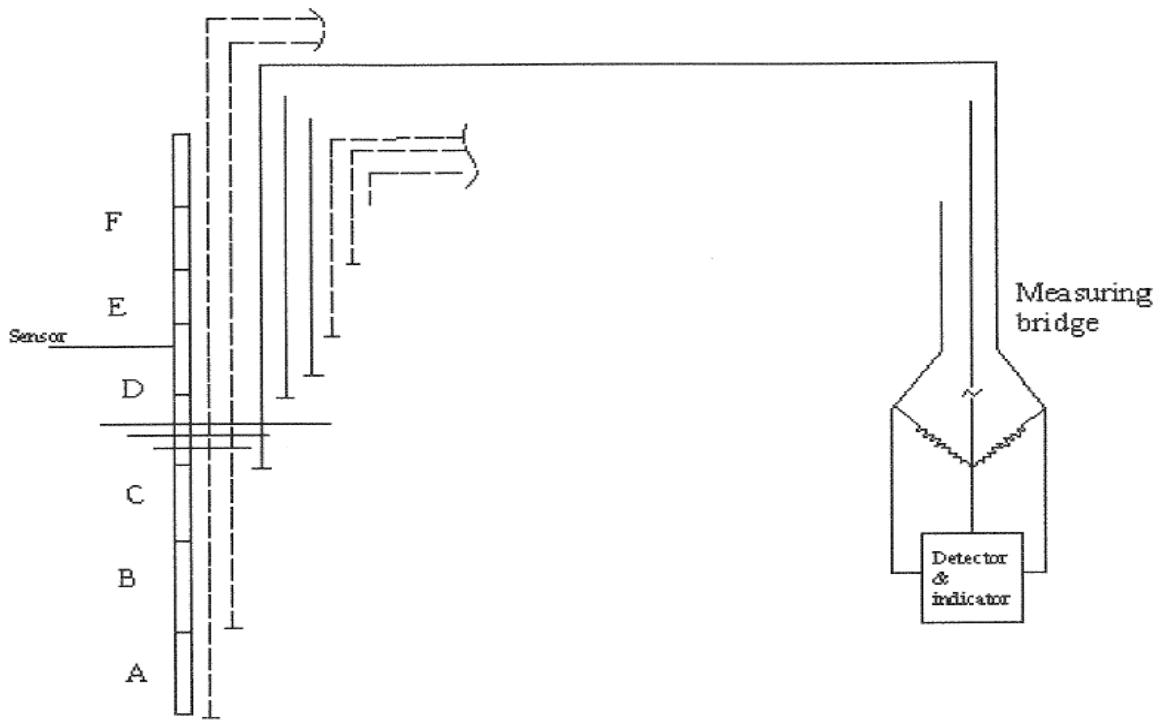

Figure 1 (K) Electrical capacitance gauge – comparative type

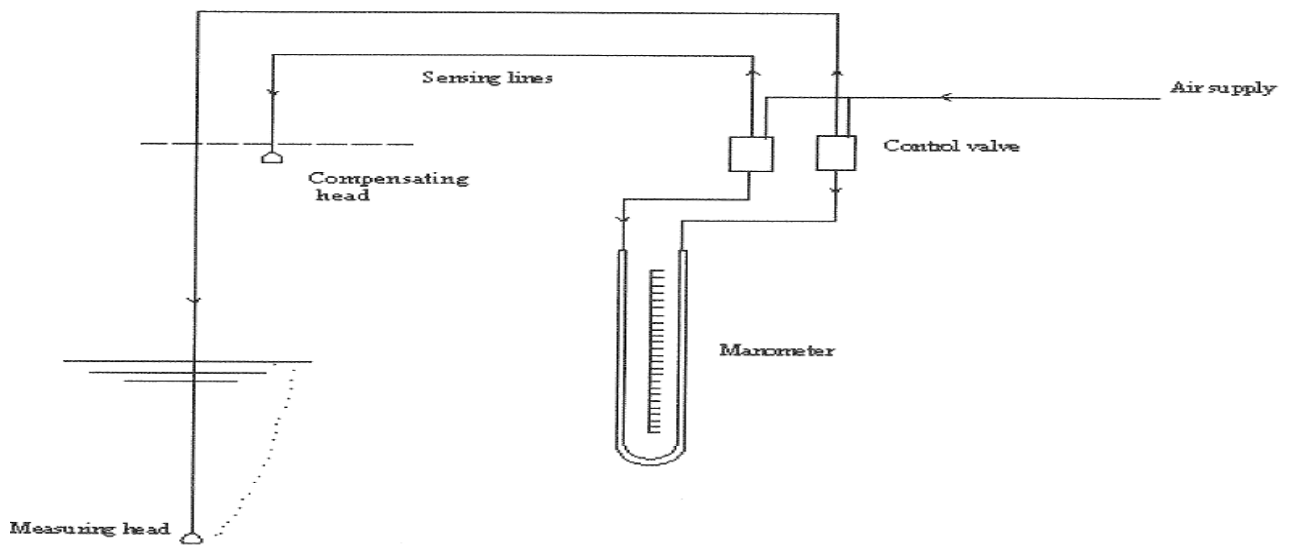
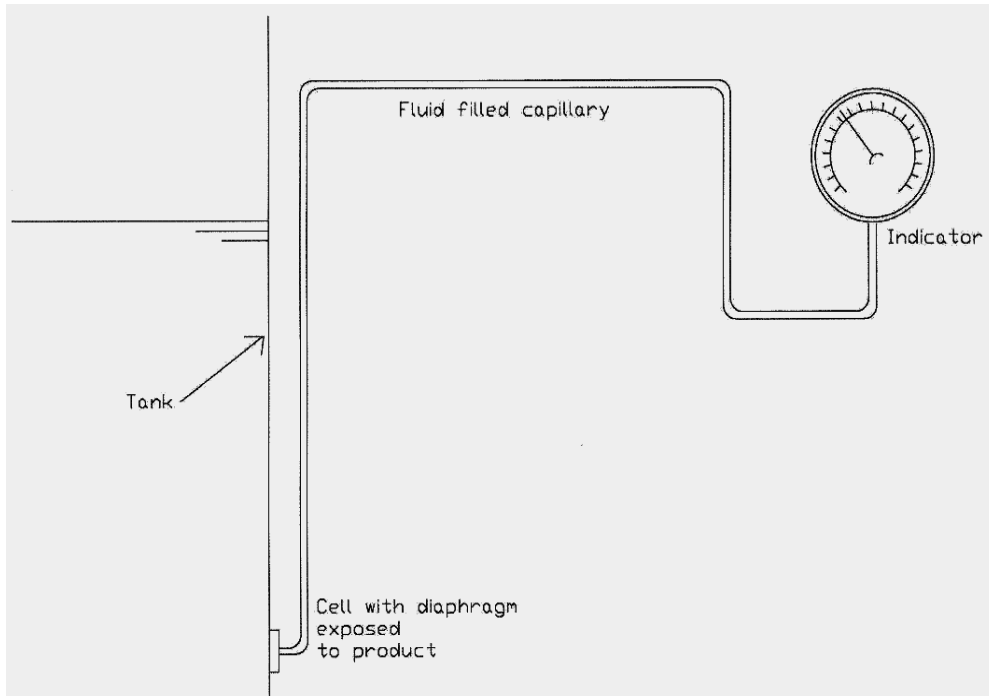
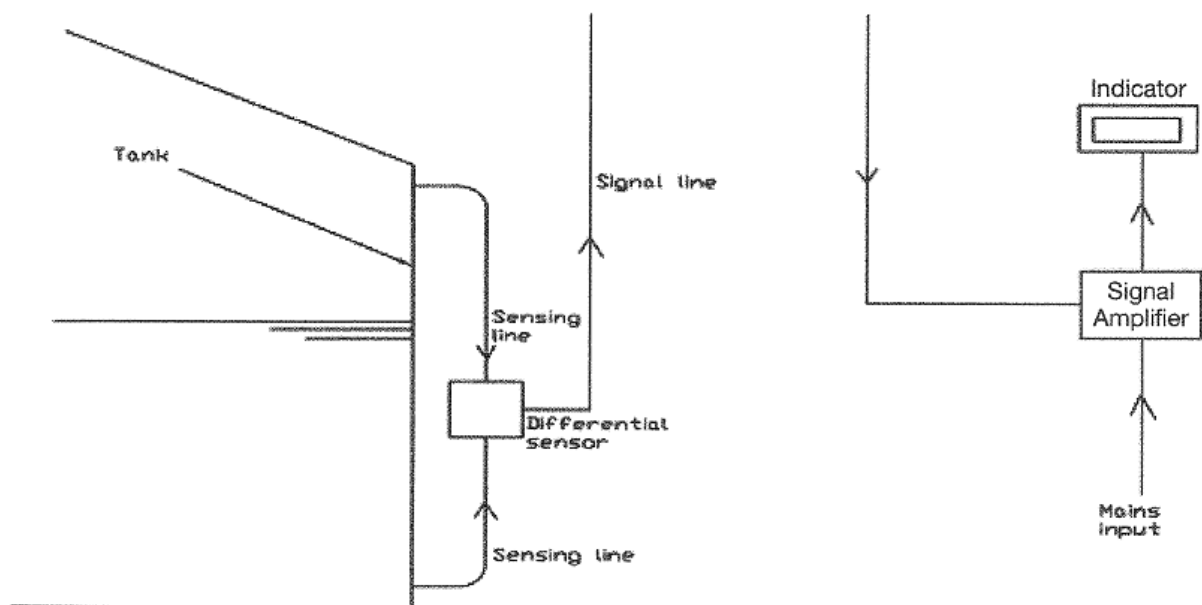

Figure 1 (L) Bubbler gauge

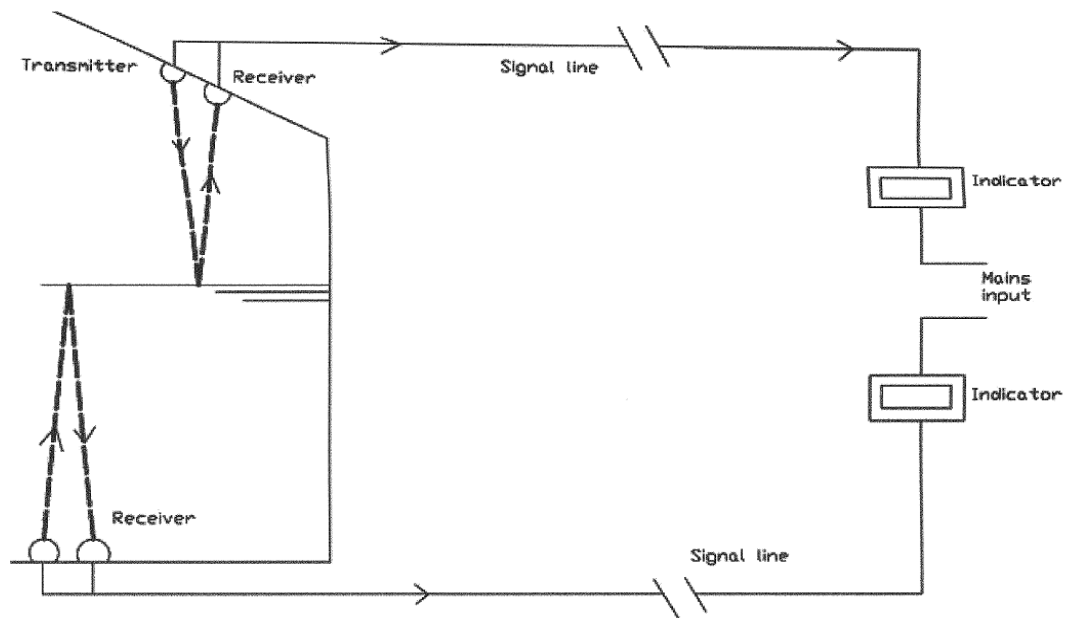



**Figure 1 (M) Pneumatic or hydraulic gauges using closed cell**



**Figure 1 (N) Differential – pressure gauge**



**Figure 1 (O) Ultrasonic level gauge**

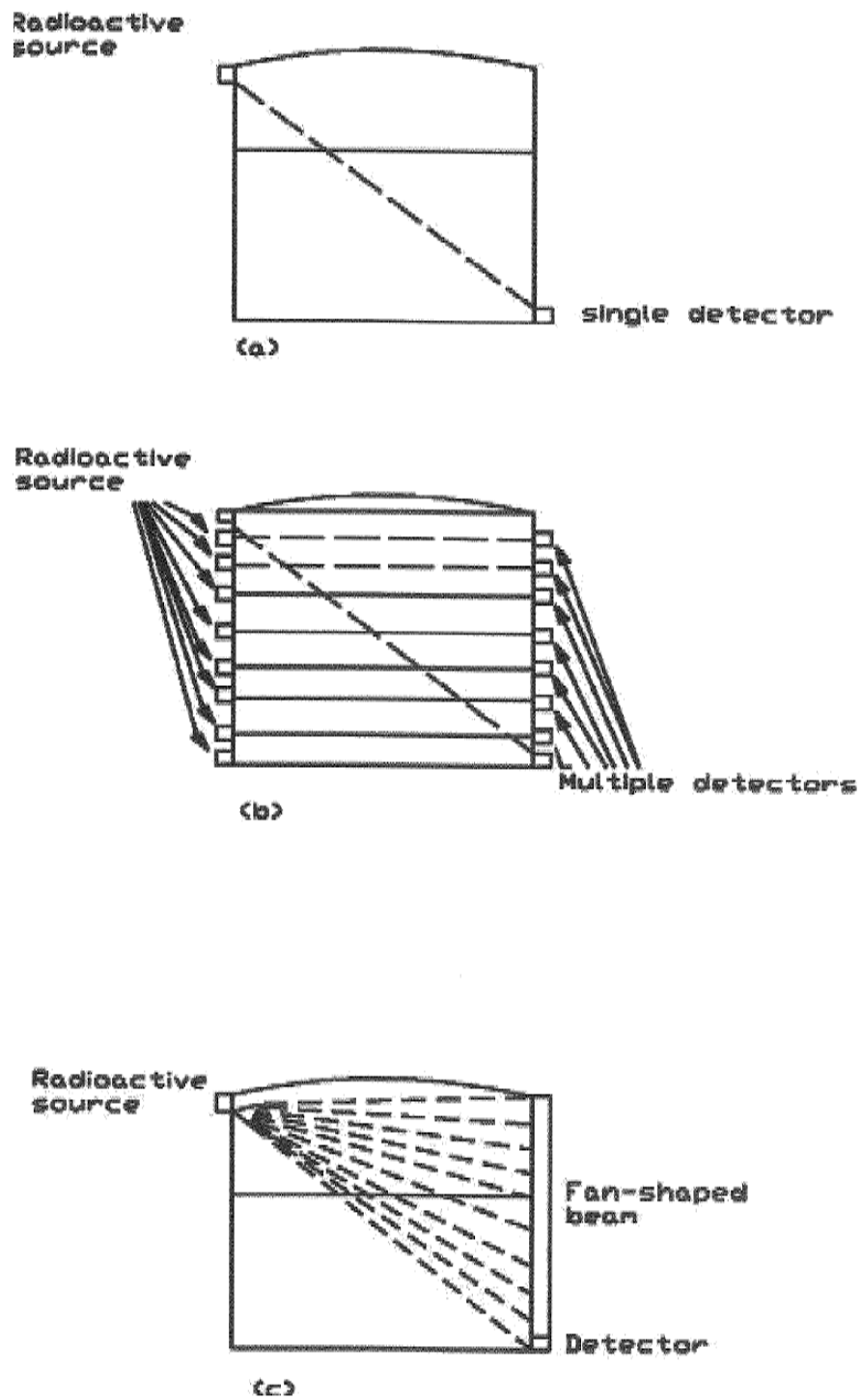
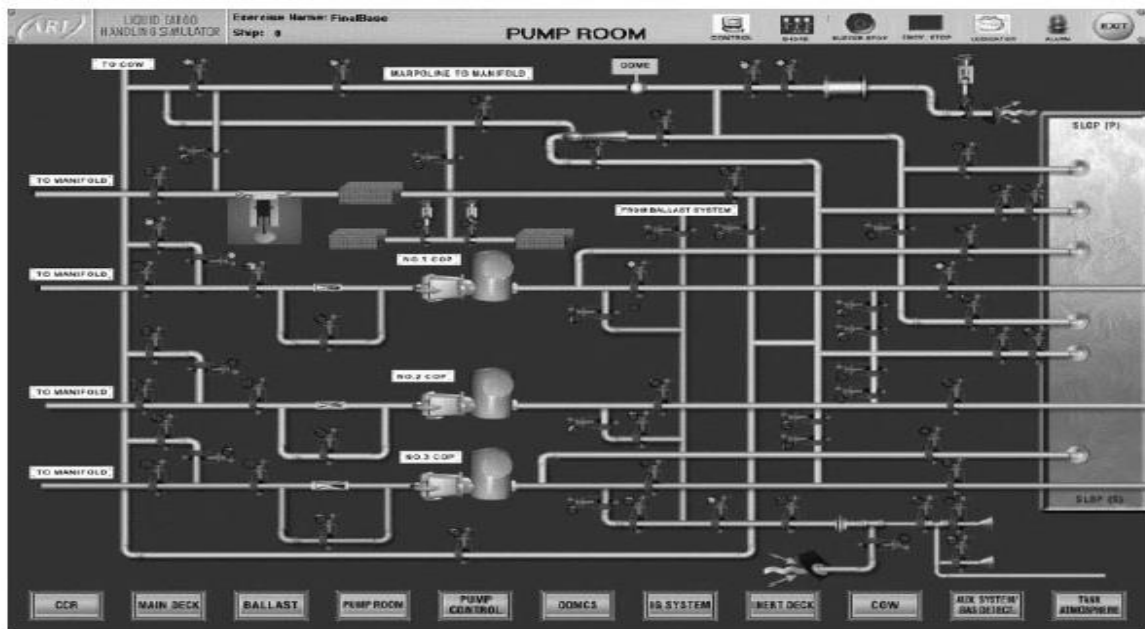

Figure 1 (P) Radioactive level – gauging methods

### Pump Room screen



This panel provides a complete view of the pump room and includes that part of the cargo system which is located here. It includes:

Figure 1 (Q) Oil tanker pump – room layout

### INERT GAS SYSTEM

#### IG SYSTEM PANEL SCREEN

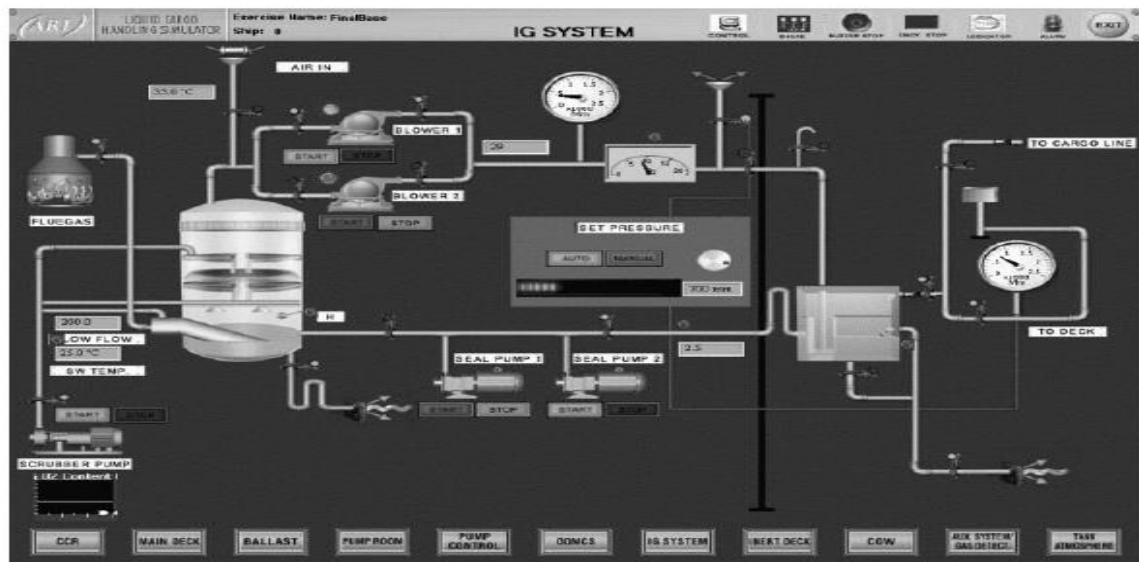
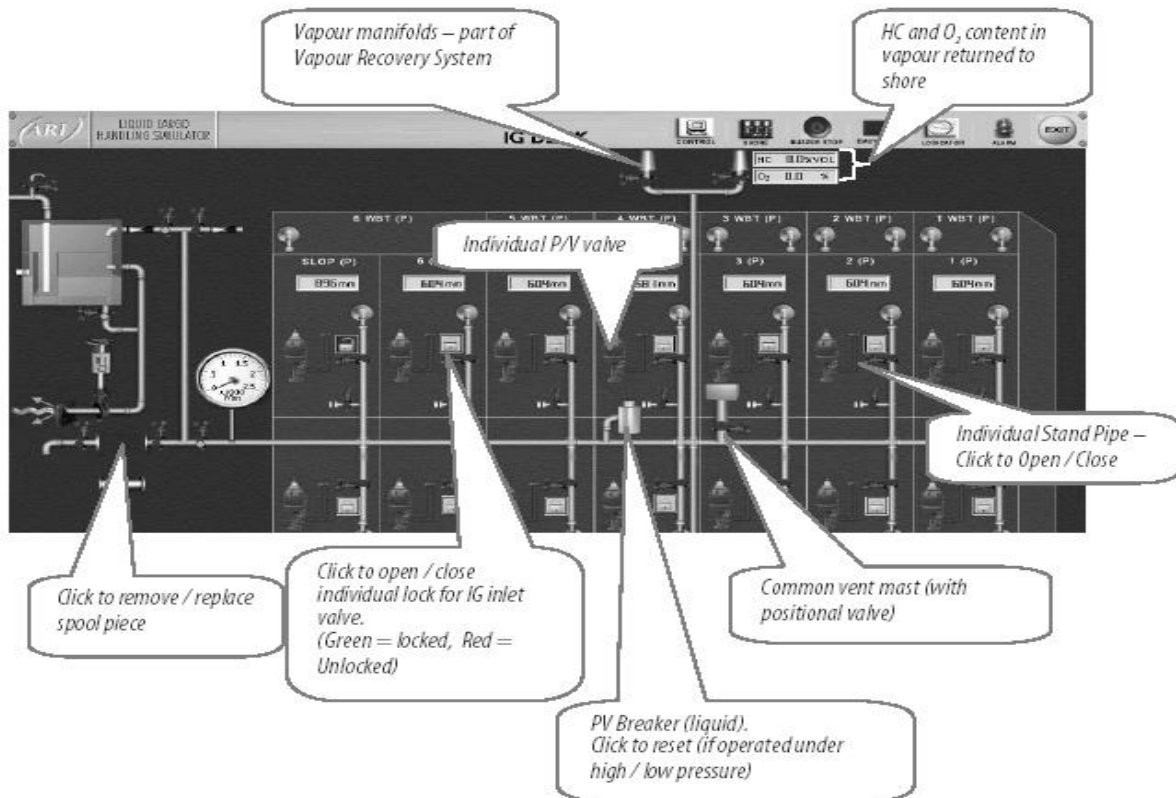

Figure 1 (R) Inert gas panel

**IG DISTRIBUTION**



**Figure 1 (S) Layout of inert Gas panel (For Deck)**

**ODMCS PANEL**



**Figure 1 (T) Oil date monitoring and control system (ODMCS) panel layout**

## TANK WASHING SYSTEM COW PANEL



Figure 1 (U) Crude oil Washing Layout

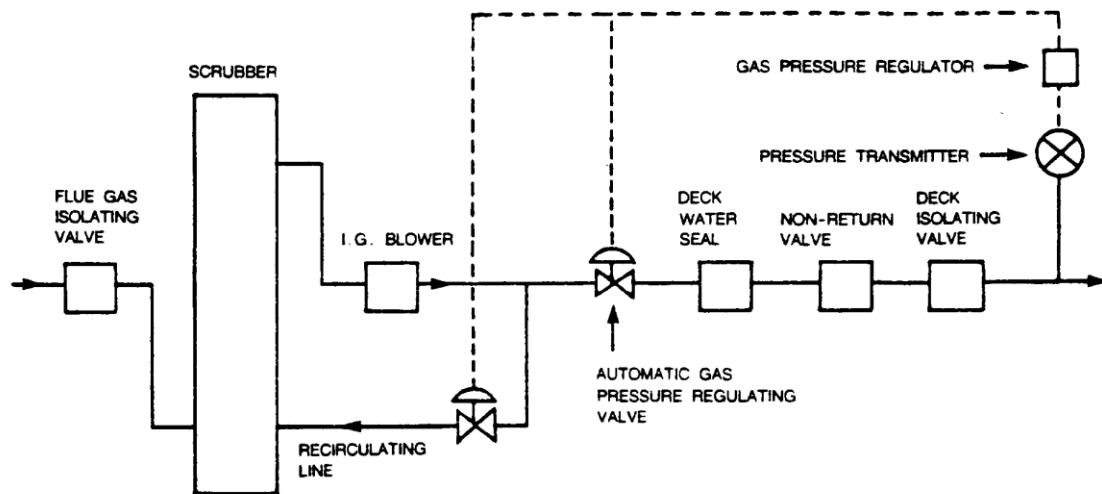

Figure1 (V) Regulating system of IGS.

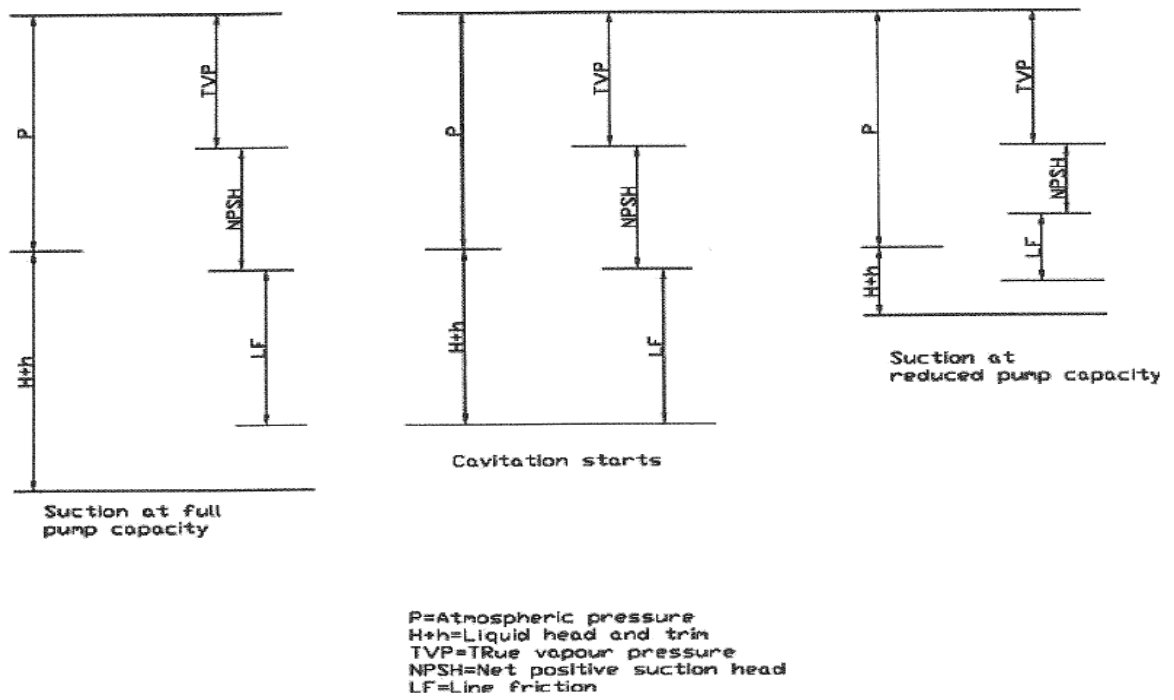

Figure 2 (A) Factors influencing suction

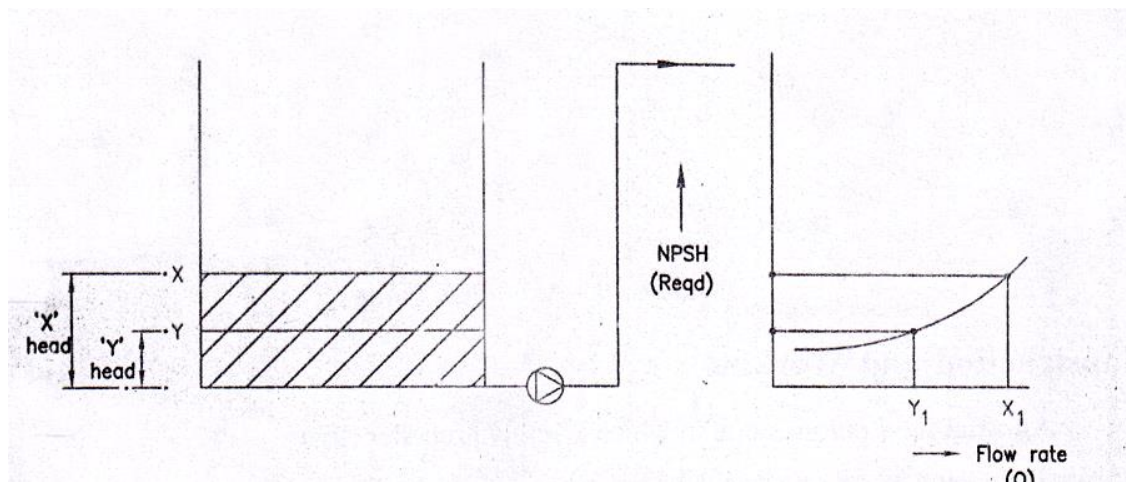
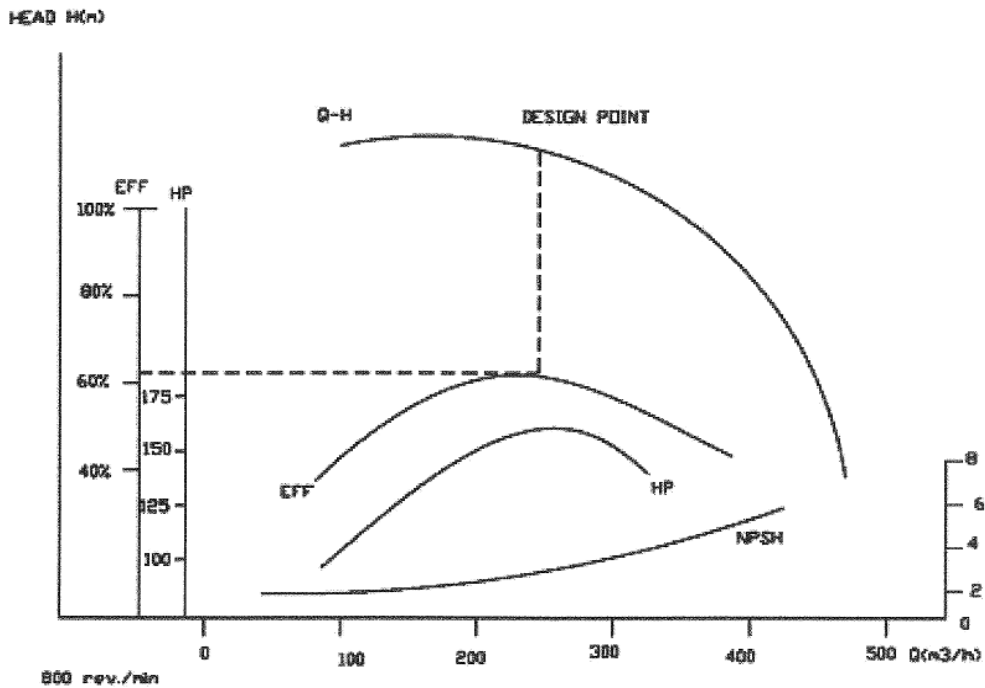

Figure 2 (A) How a Full Tank Increases suction influencing suction



Q = Discharge rate  
 EFF = Pump efficiency  
 HP = Power consumption  
 (R.D of Liquid = 1.0)  
 NPSH = Net positive suction head

Figure 2 (B) Pump characteristics

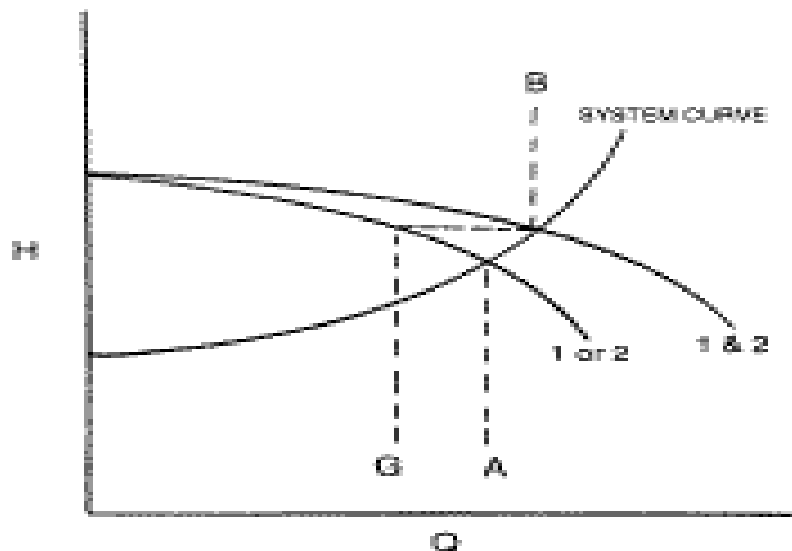
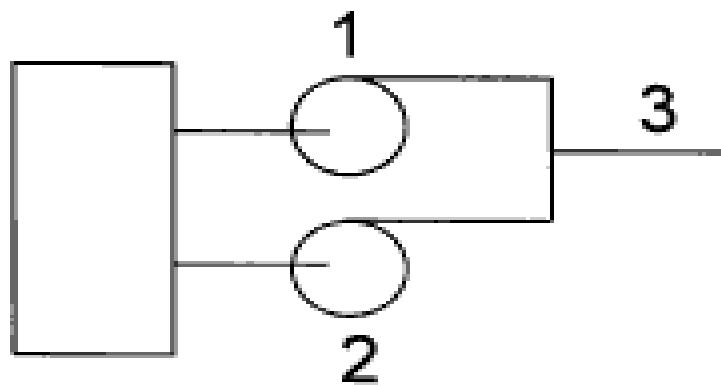

Figure 2 (C) The influence of shore curves on parallel pumps





**Figure 2 (D ) General Arrangements of the FRAMO Pumping system**



**Figure 2(E) Shows Pumps connected in Parallel**

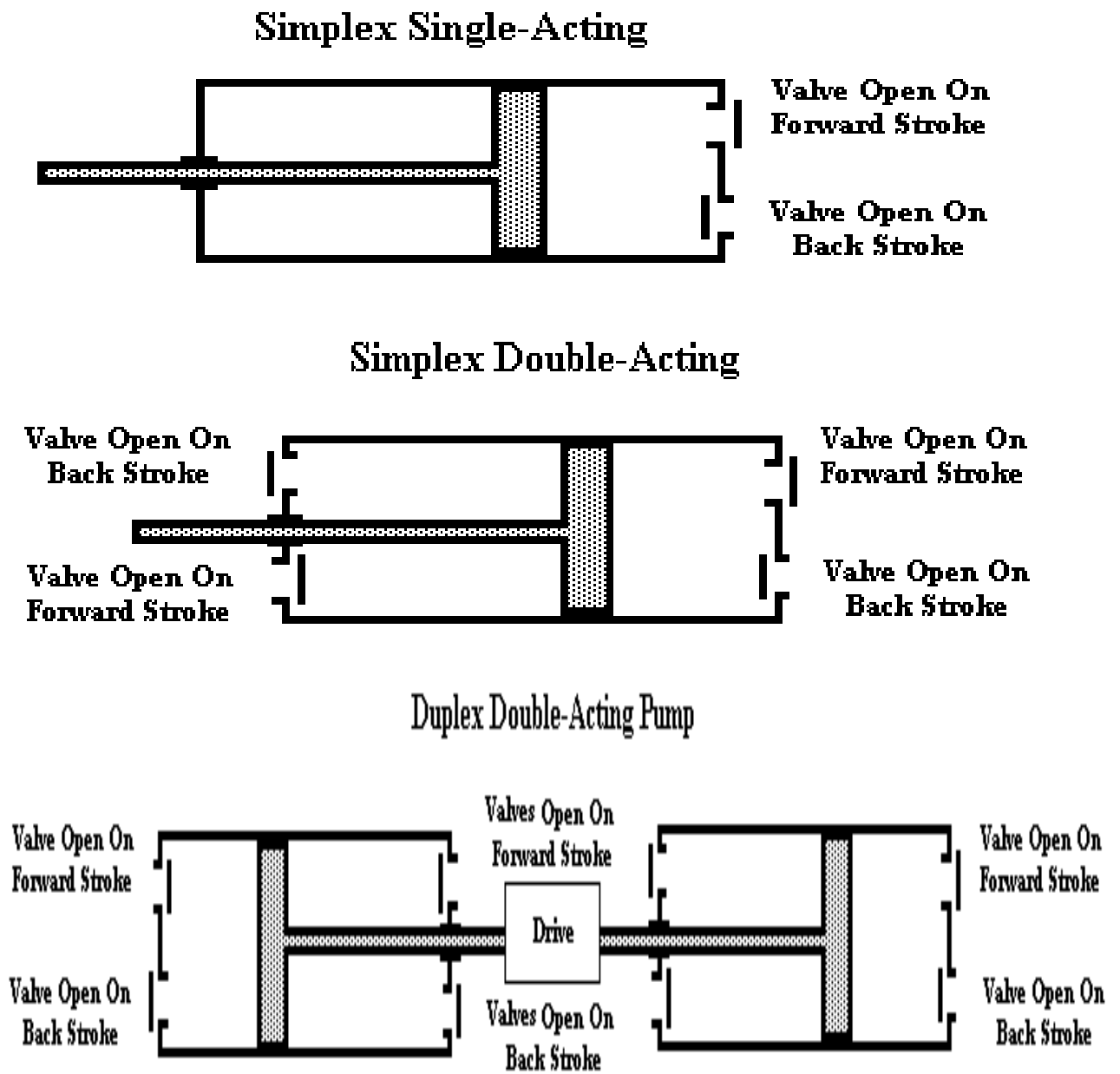

Figure 2 (F) Reciprocating Pumps Operations

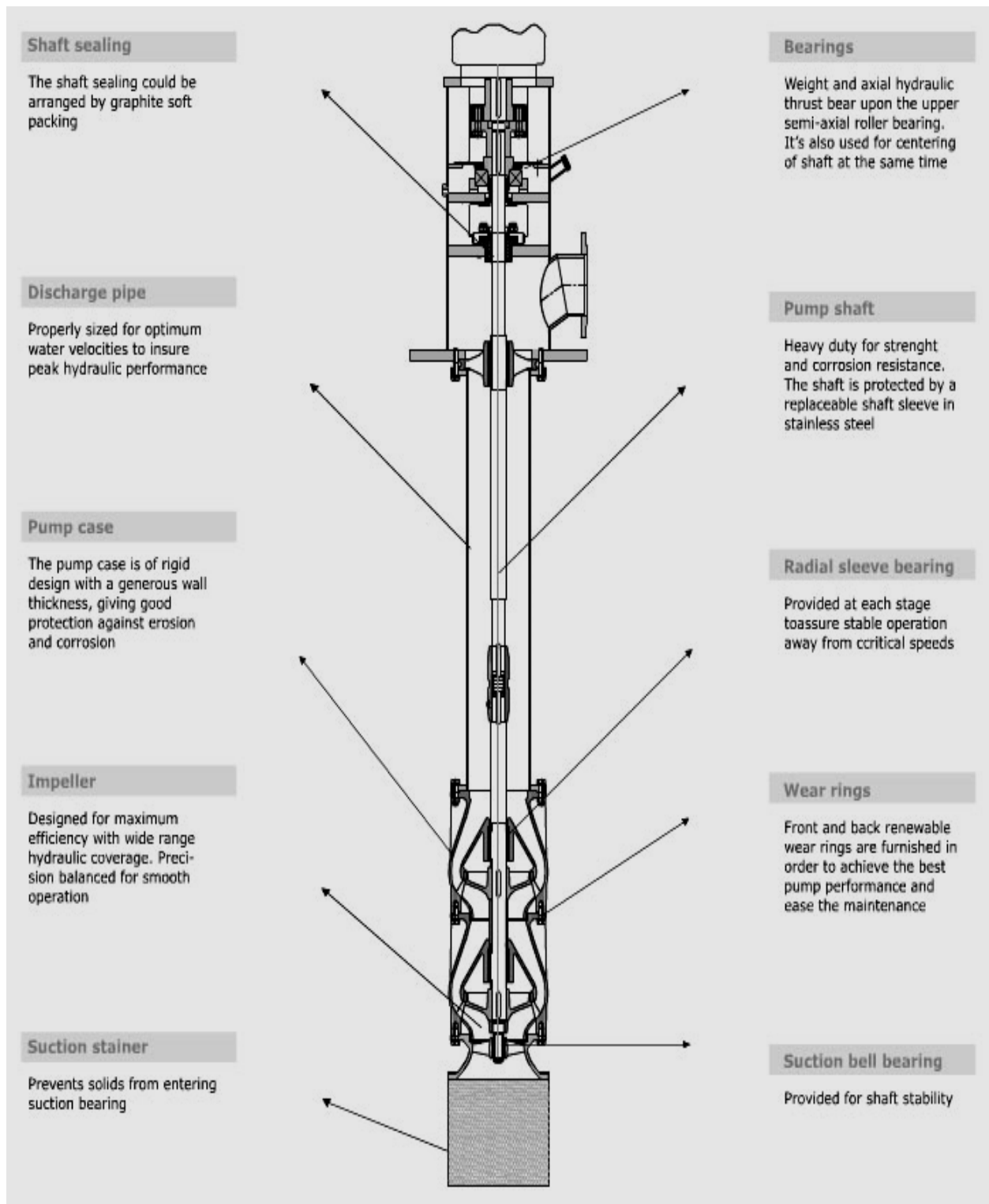
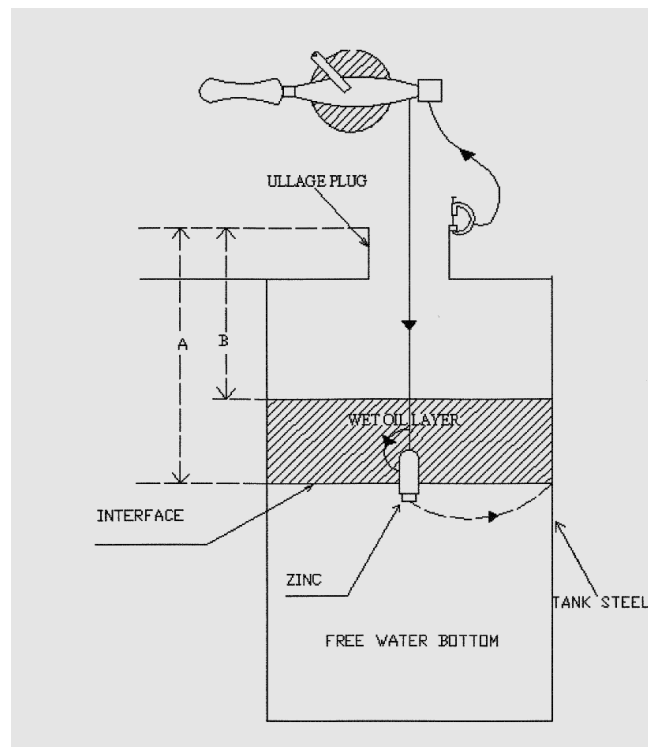

Figure 2 (G) A Deep well pump of a product/chemical tanker



**Figure 5 (A) Oil/water interface detector**



**Figure 5 (B) Ship -Shore Loading arm to Manifold Connection**

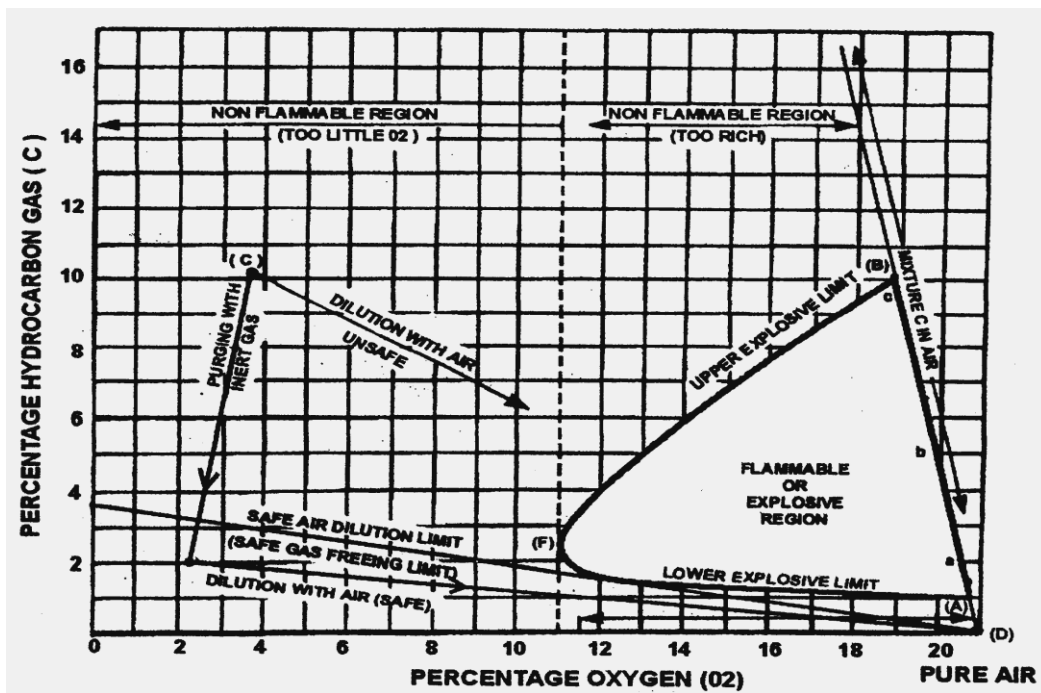

Figure 5 (B) Shows how the use of Inert gas enhances safety in Tanker operations



Figure 7 (A) Gas monitoring Equipment

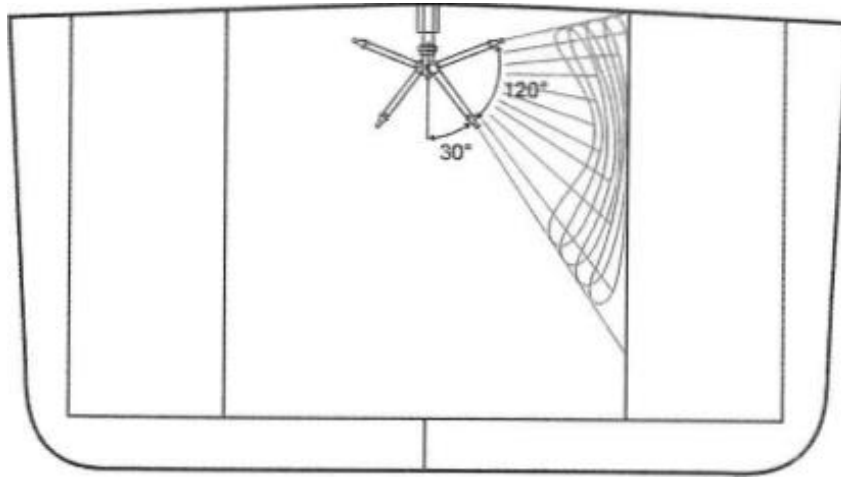

Figure 7 (B) COW machine angle showing Top wash

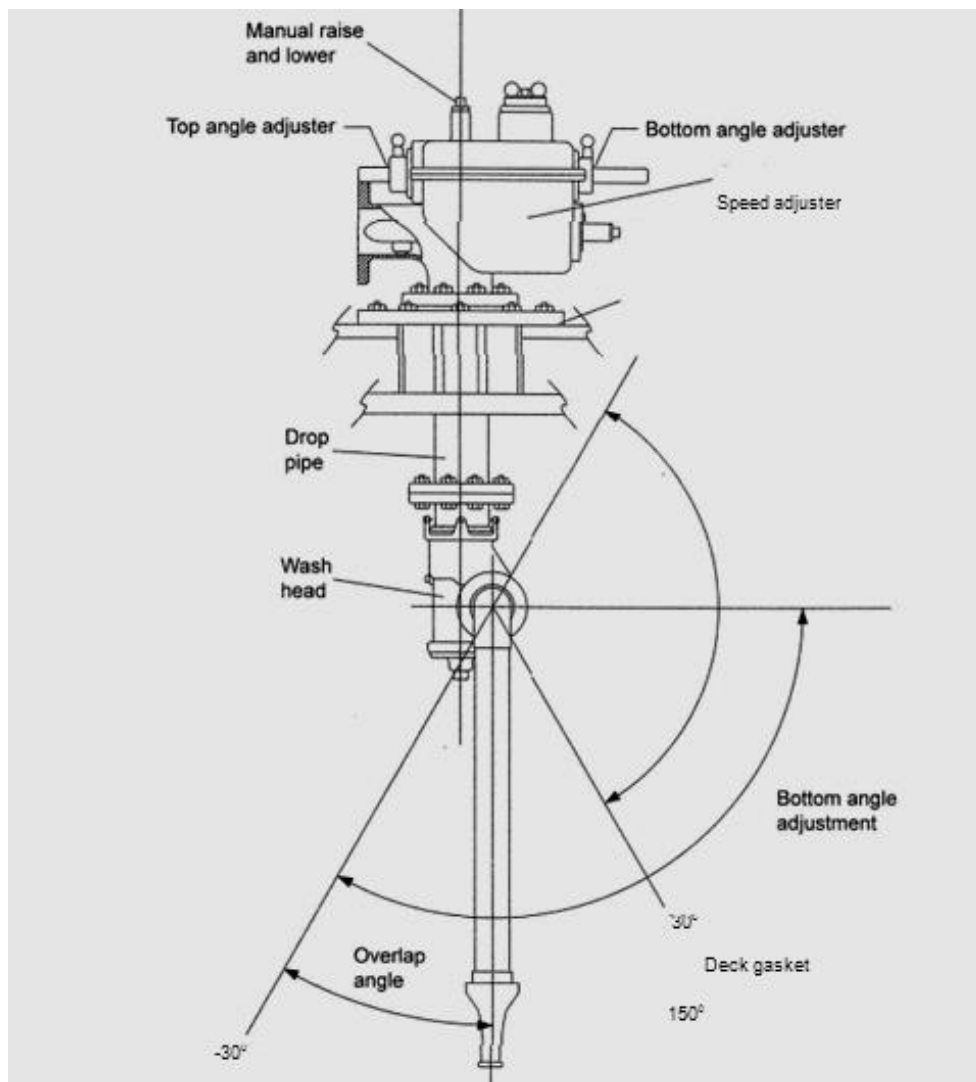

Figure 7 (C) COW machine angle showing bottom angle adjustment

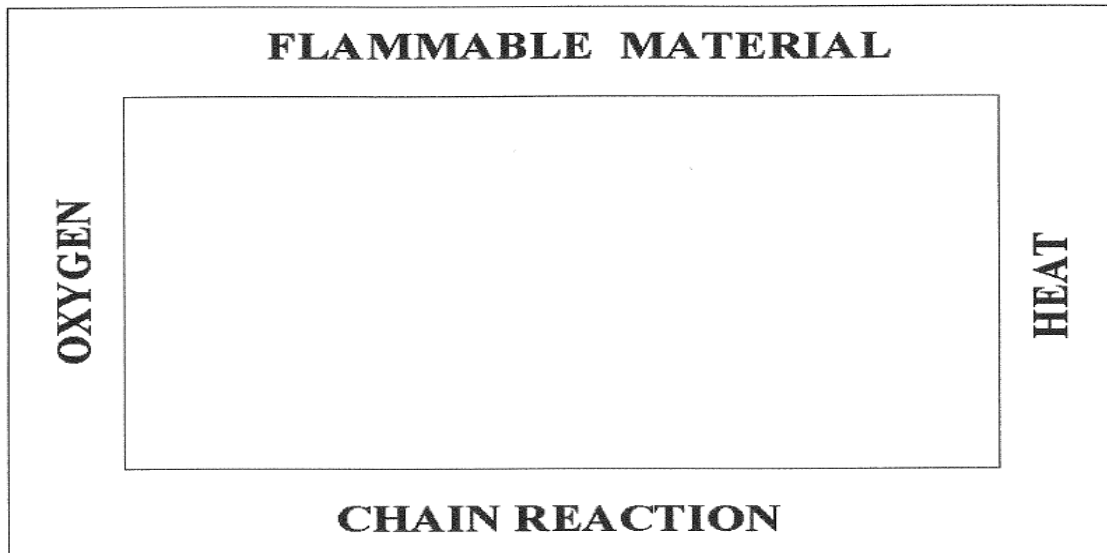

Figure 14 (A) fire tetrahedron

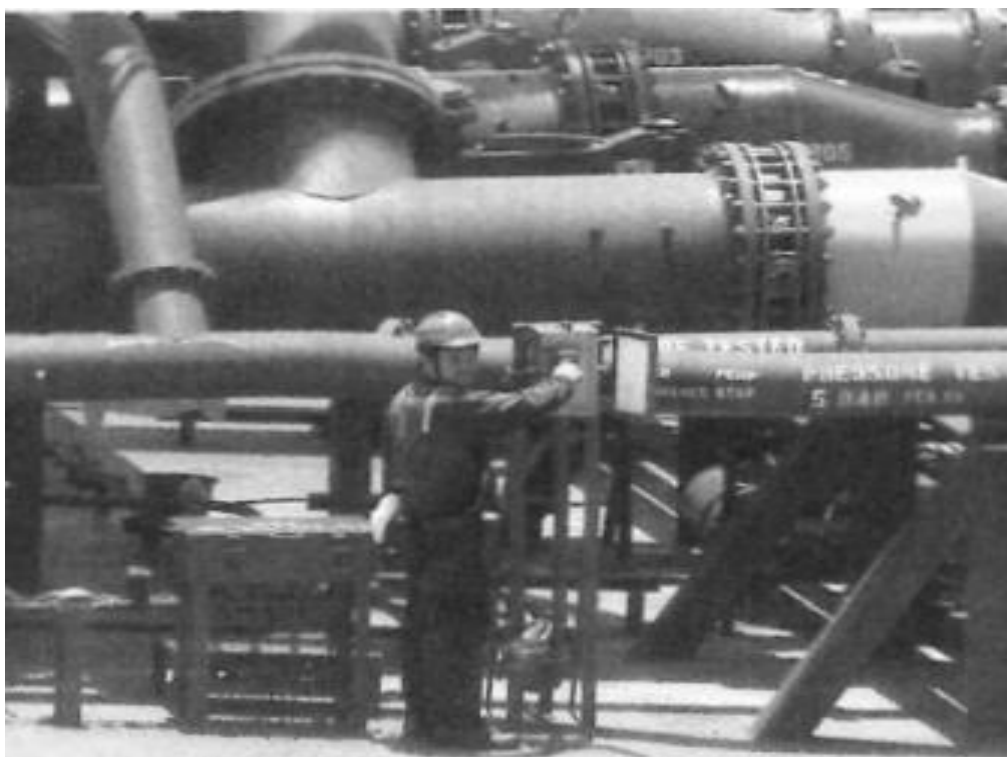

Figure 14 (B) ESD being operated.

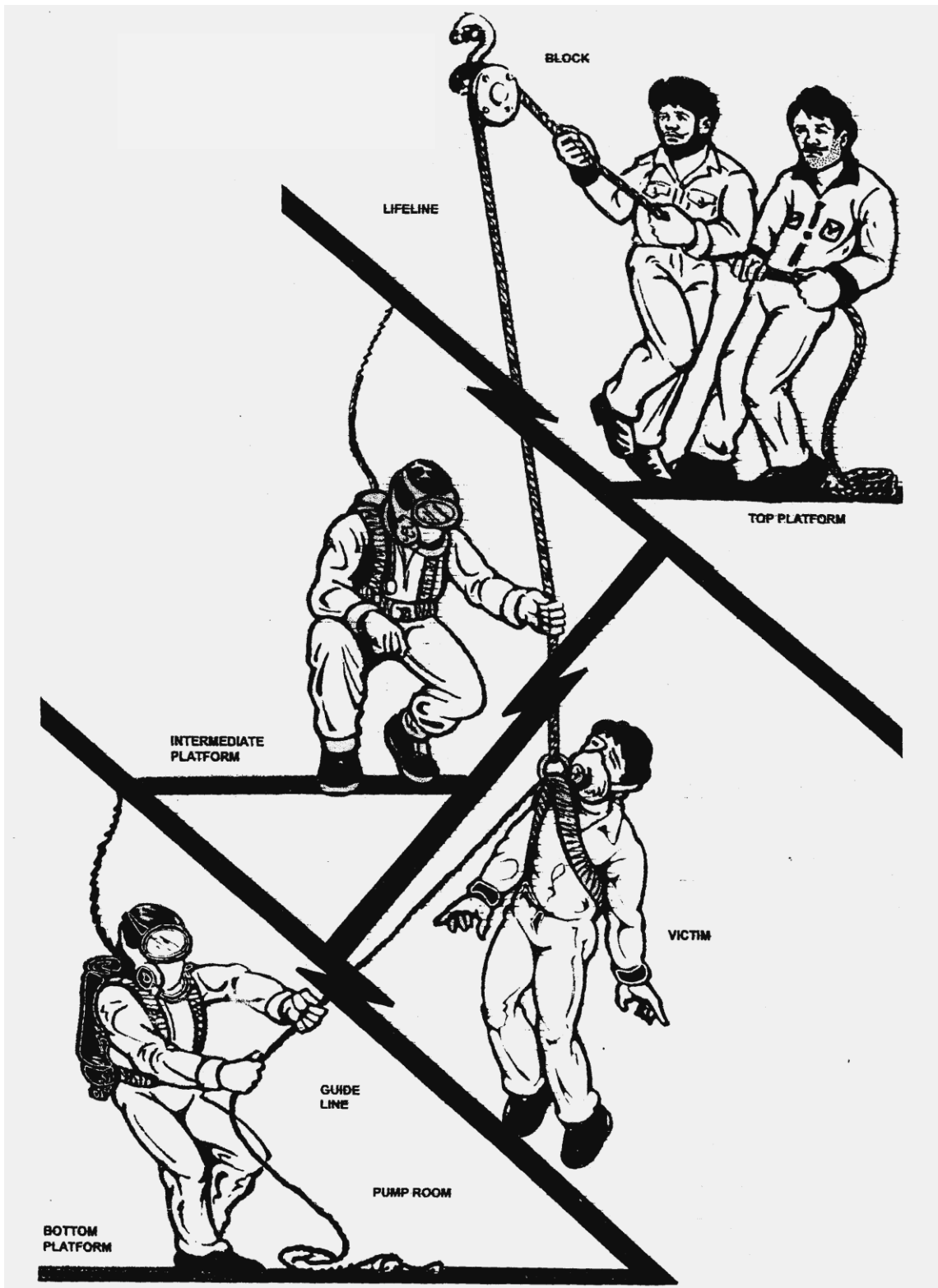
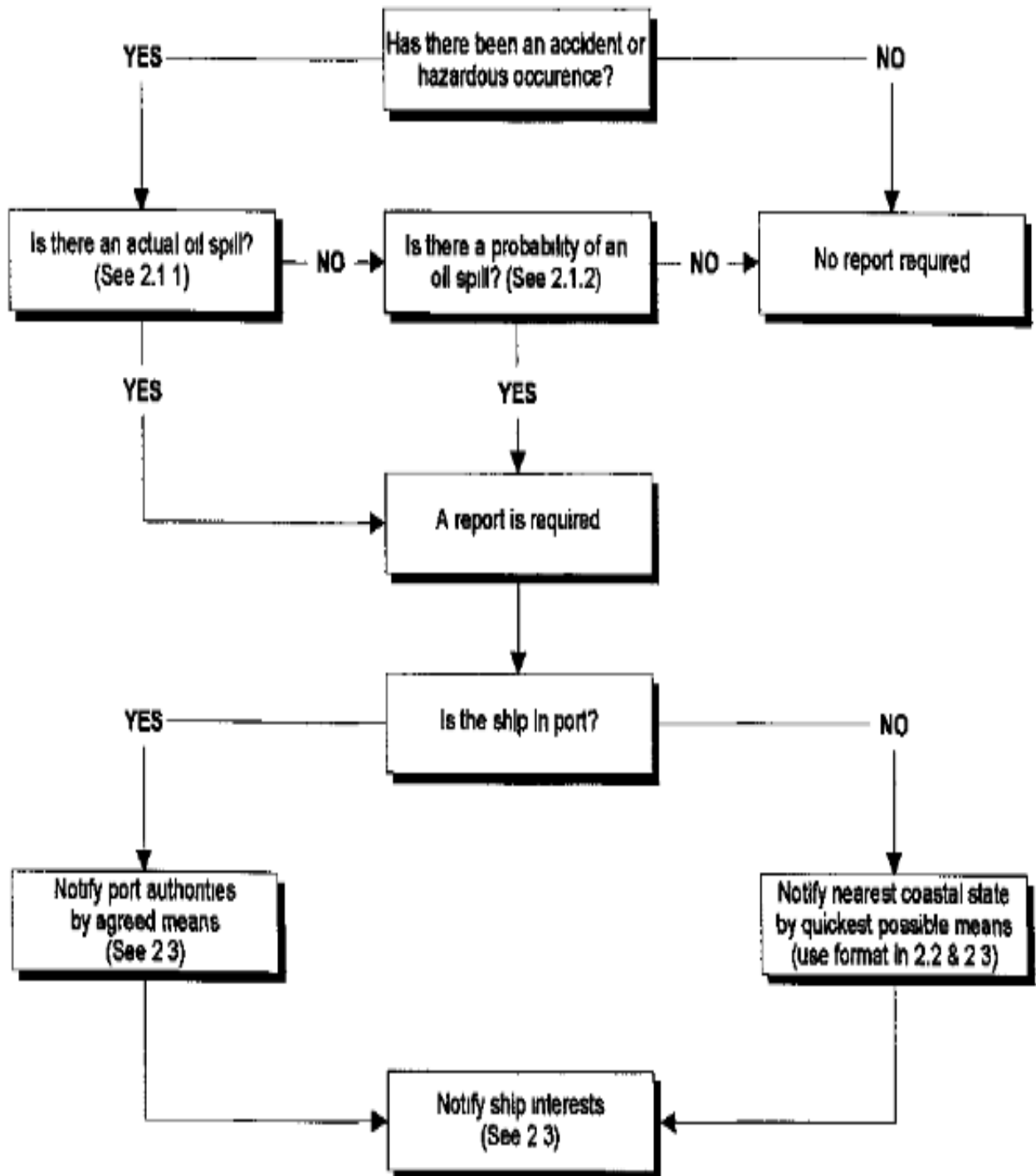



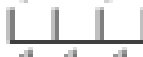







Figure 14 (C) Pump room rescue.





**Fig. 15.6A Spill reporting requirements**

<b>01</b> Date and time of event (UTC) 	
<b>02</b> (Position, latitude, longitude) 	<b>03</b> (Bearing, distance from landmark) 
<b>04</b> (Distance) 	<b>05</b> (Speed) 
<b>06</b> (Intended track)	
<b>07</b> (Radio station(s) operated)	
<b>08</b> (Date and time of next report, UTC) 	
<b>09</b> (Type and quality of cargo / load on board)	
<b>10</b> (Brief details of damage / deterioration / damage)	
<b>11</b> (Brief details of pollution, incl. estimate of quantity lost)	
<b>12</b> (Brief details of weather and sea conditions) Wind direction  Wind force  Sea direction  Sea height 	
<b>13</b> (Contact details of ship's owner / operator / agent) Manager Operator Agent	
Page 2 of 2	
<b>14</b> (Ship size and type) Draught, Length, Breadth, Type.	
<b>15</b> (Additional information) Brief details incident, Needs for material assistance, Actions being taken, Number of crew / details of injuries, Details of P&I club	
Local correspondence:	

**Fig 15.6 B Spill reporting format**

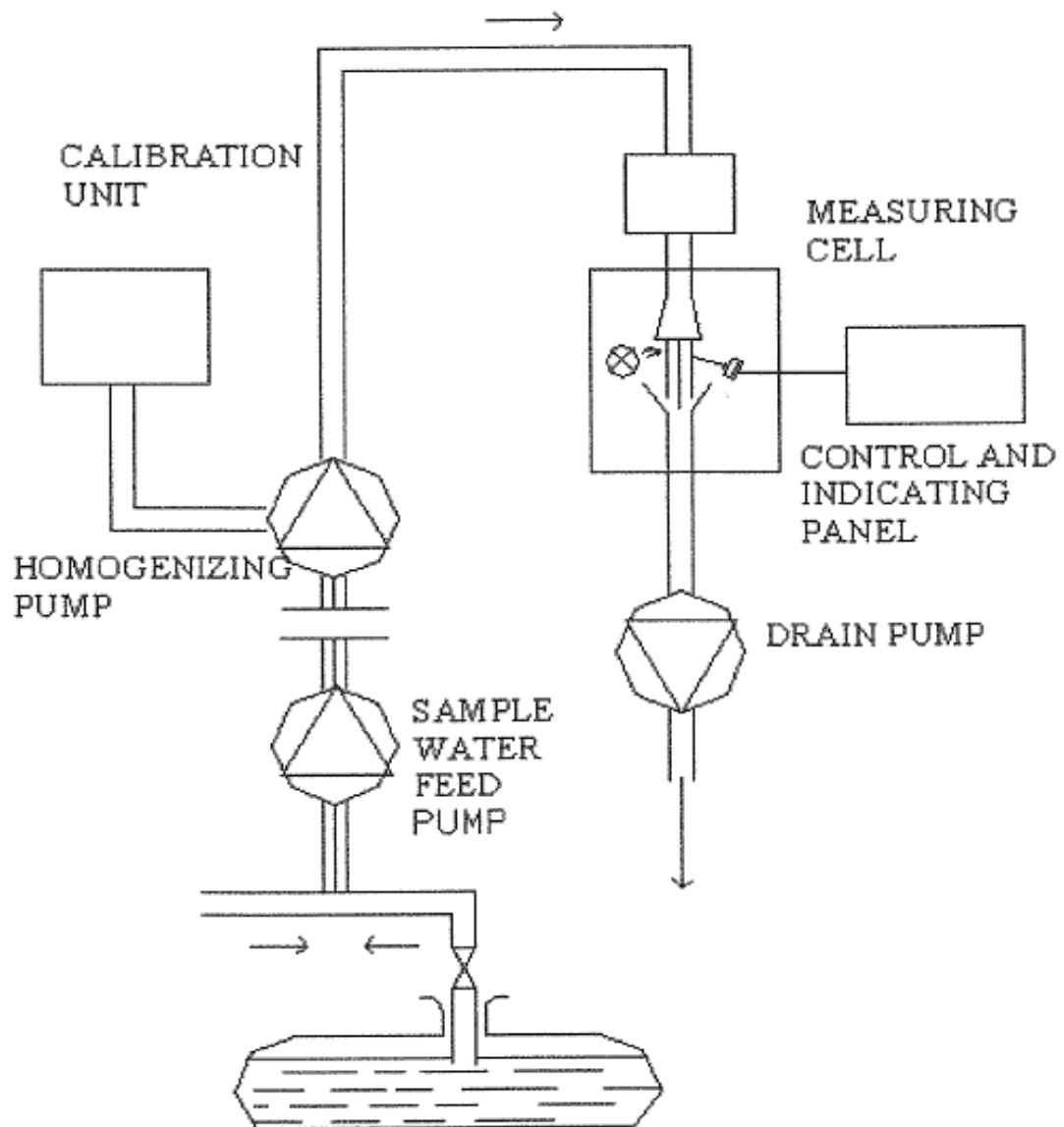

Figure 18 (A) Oil content meter working with fluorescence

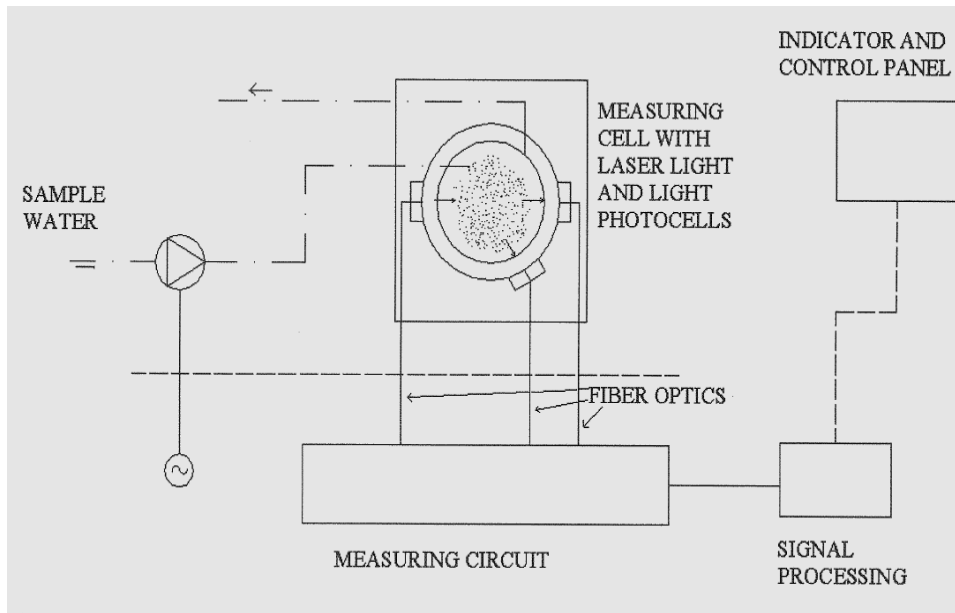

Figure 18 (B) Oil content meter working on light – scattering principle

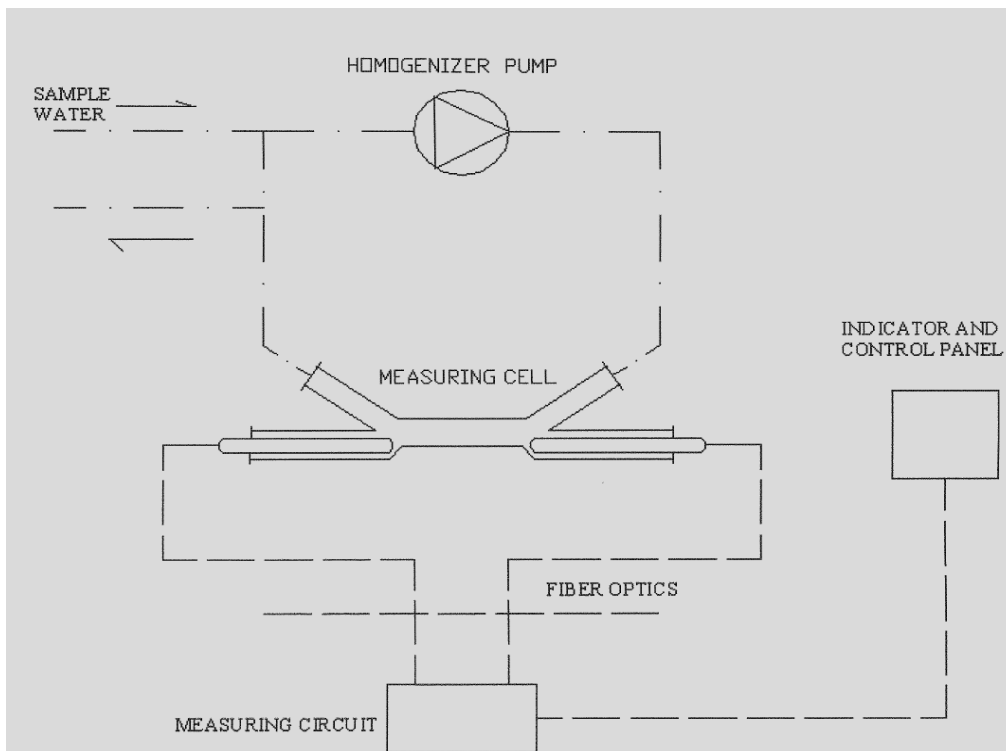
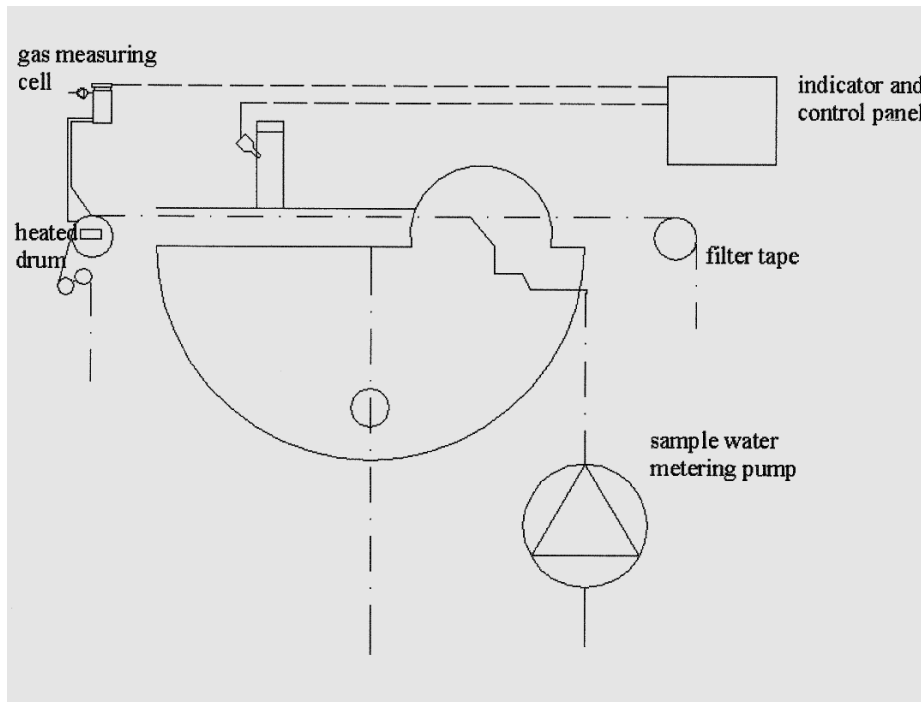
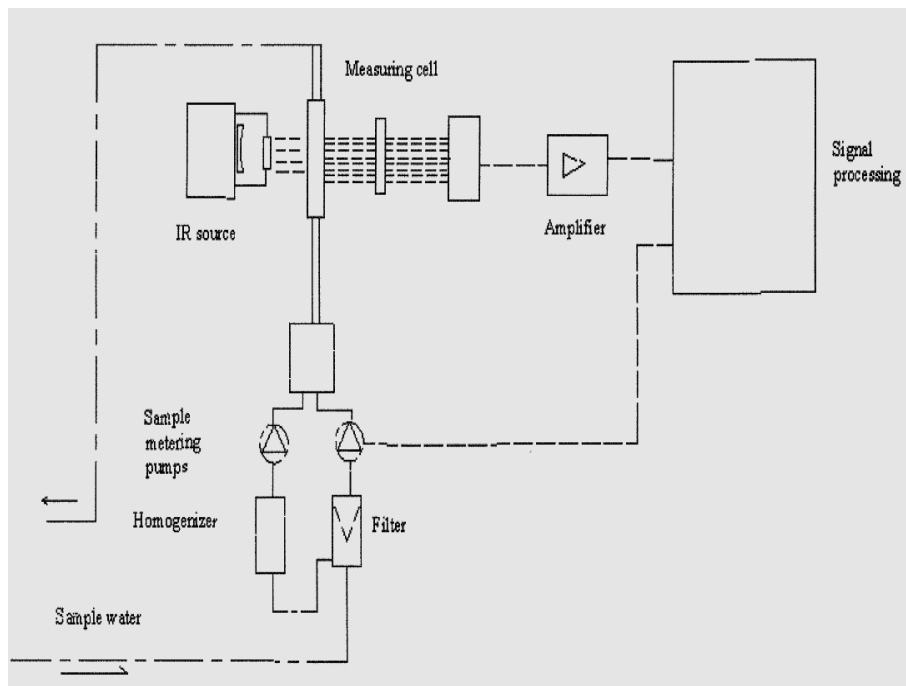

Figure 18 (C) Oil content meter working on turbidity principle



**Figure 18 (D) Oil content meter working with discoloration and gas measurements**



**Figure 18 (E) Oil content meter working with direct infra – red absorption**

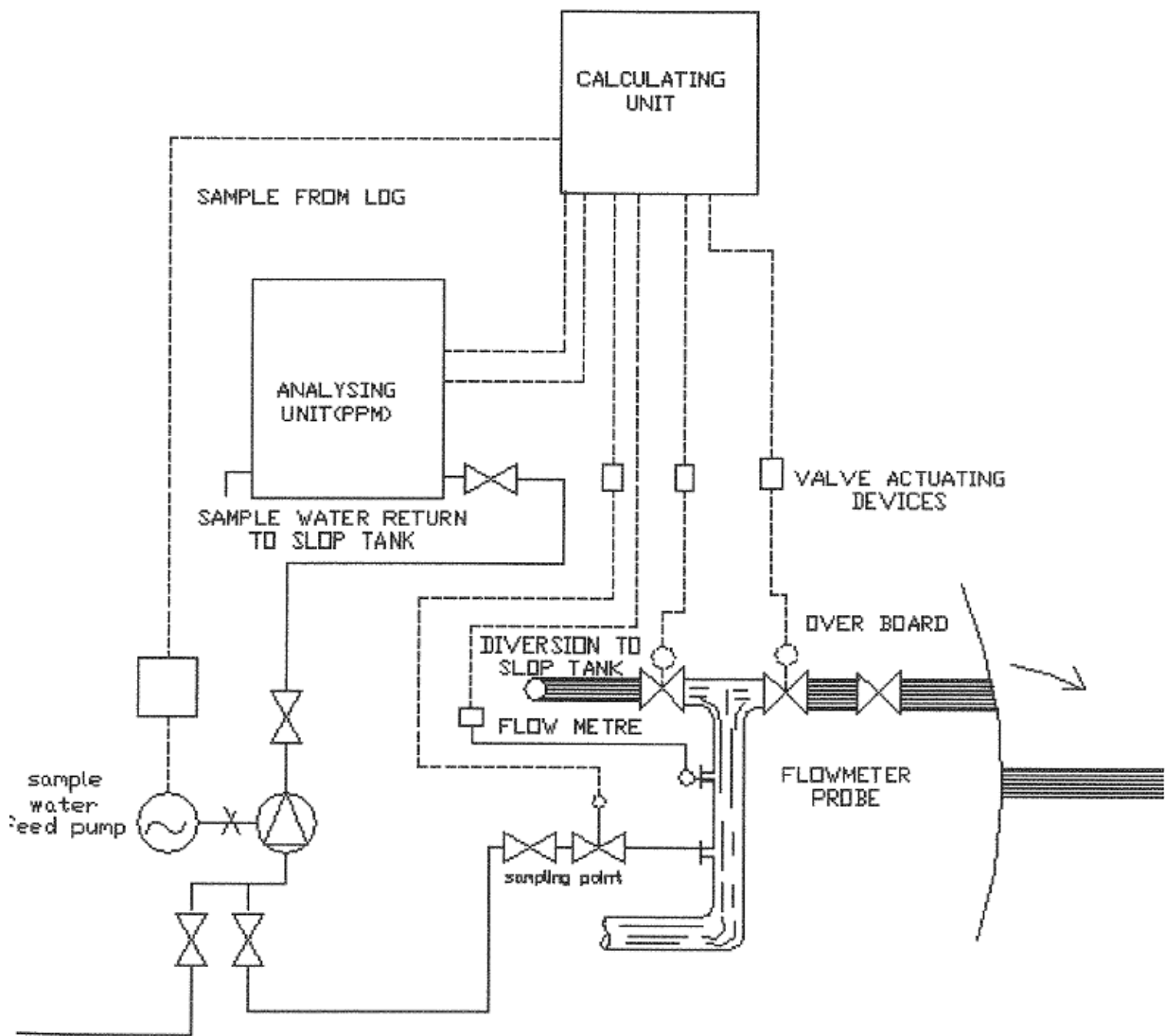

Figure 18 (F) Arrangement of oil content monitoring and control system

## **APPENDIX 2: EXERCISES**

The exercises below are to be carried out on a simulator or table top. For tabletop exercises the candidates should be provided with PC loaded with a tanker's loadicator software and hard copies of ship's capacity, pumping, ballasting, ventilation (inerting), tank cleaning plans and calibration tables of ballast and cargo tanks.

### **EXERCISE NO. 1**

#### **Exercise No. 1: Cargo Handling Simulator Layout**

##### **Objectives:**

Understanding of the sub-systems and their overall interactivity in the cargo handling simulator and the operations involved. Becoming familiar with terminology used in oil cargo transport and operations.

##### **Prerequisites:**

The theoretical aspects of the various kinds of liquid cargo transport should be known to the trainees. Basic tanker operations knowledge will have been studied prior to simulator exercises. Basic stability, strength and stress theory will have to be known by the trainees.

**Simulator Condition:** Not applicable

##### **Briefing:**

Explanation of the ship type modeled.

Explanation of the various sub-systems and how they connect in real life

Explanation of the Loadicator functions, trim, draught, and heel indicators in the simulator.

Check if all systems understood and interconnection of systems in simulator.

Discuss if relationships with previous theory are properly understood.

**For table top exercise candidates should be familiarized with a ship's loadicator programme on a PC and the ship's capacity, pumping, tank cleaning, ballasting, ventilation (inerting) plans and the cargo system.**

## **EXERCISE NO. 2: INERTING CARGO TANKS**

### **Objectives:**

Understanding the principles, operations and safety precautions involved with inerting of cargo and slop tanks.

### **Prerequisites:**

Introductory exercises will have been completed such as no. 1.  
Theory of UEL, LEL and explosive mixtures will have been covered as well as explosion triangles.

### **Simulator Condition:**

Cargo tanks empty, filled with air.  
Normal ballast condition.

### **Briefing:**

Composition of the tank atmosphere to be checked and students explained levels of safe inerting.

If simulator is not available candidates explained level of safe inerting and procedure of checking tank atmosphere.



## **EXERCISE NO. 3: LOADING FULL CARGO**

### **Objectives:**

By loading a full cargo into the vessel, appreciating efficient cargo planning, stability and stress criteria and maximum allowable draft and trim.

### **Prerequisites:**

The trainees will have performed familiarization exercises on the simulator and they will have knowledge of loading zones, stability, shear forces and bending moments.

### **Simulator Condition:**

Cargo tanks empty, tanks inerted. Normal ballast condition.  
Shore connection for 1 grade and 1 temperature of cargo in all tanks.

### **Briefing:**

Trainees should be told that all tanks are empty and segregated ballast tanks full for normal ballast condition.

Tanks have to be filled to 98%

Shear forces and bending moments to be kept within limits; preliminary check can be done by off-line Loadicator.

When loading, tank gas to be vented to shore (or vent riser on vessel or from individual high velocity pv valves)

Trainees can perform preliminary stress check with the Loadicator.

Connection to shore manifold to be made and tank filling to commence simultaneously or in order according to stress limitations.

When loading tanks, levels to be monitored as well as tank atmosphere and shear forces and bending moments.

Ballast to be pumped out in accordance with the loading sequence.

**For table top exercise candidates to make a loading plan showing different stages of loading/deballasting using bar charts.**

**Candidates to use the pumping and ventilation plan to indicate proper lining up.**

**Loadicator to be used.**

## **EXERCISE NO. 4: PURGE AND VENTILATE CARGO TANKS FOR ENTRY**

### **Objectives:**

Preparing cargo tanks for entry after containing hydrocarbon cargo.  
Knowledge of how to purge cargo tanks with inert gas to safe level before starting to ventilate with air.

### **Prerequisites:**

Familiarization exercise no. 1  
Inerting exercise no. 2  
Theory of explosion limits – LEL and UEL  
Threshold limit values (TLV)

### **Simulator Condition:**

Vessel ballasted to normal seagoing condition.  
All cargo tanks empty.  
Tank atmosphere – Empty and under HC vapour.

### **Briefing:**

The different status of tanks to be explained to trainees.  
HC and O<sub>2</sub> differences to be pointed out.  
Use of IG system, P/V valves and venting system.  
Objective to maintain proper tank atmosphere composition during whole operation.

For table top exercise, candidates to use the ventilation (Inerting) plan to indicate lining up. Time taken for purging and gas freeing to be calculated stating method used (displacement or dilution).

## **EXERCISE NO. 5: DISCHARGING, CRUDE OIL WASHING (COW) AND BALLASTING**

### **Objectives:**

By means of this exercise the relationship between the various sub-systems is supposed to be demonstrated and the overall understanding of simultaneously discharging, ballasting and COW to be demonstrated and realized.

### **Prerequisites:**

Familiarization exercises, Discharging exercise, Washing/ tank cleaning exercise, Ballasting exercise

IG usage exercise, Theoretical knowledge of shear force, stress, trim, heel is required.

Pollution prevention rules and procedures have been discussed.

### **Simulator Condition:**

Cargo tanks loaded with crude oil.

Slop tanks 50% full.

Tanks inerted, IG system standby.

No ballast

### **Briefing:**

The trainees should be convinced of the complexity of the exercise, which should be built up step by step.

Discharging and inerting to be started first.

Stress, trim and heel to be monitored.

Unloading, Cow'ing and ballasting according to pre-prepared plan.

Time needed to complete operations will be a measure of efficient conduct of operations.

**For table top exercise candidates to make a unloading plan showing different stages of unloading/deballasting and COW using bar charts.**

**Candidates to use the pumping, ventilation and tank cleaning plan to indicate proper lining up.**

**Method used for COW to be noted in the plan.**

**Loadicator to be used.**

## **EXERCISE NO. 6: CLEANING/WASHING CARGO TANKS**

### **Objectives:**

The trainees will be able to perform tank cleaning operations.

The trainees will appreciate the use of inert gas during the washing operations.

The trainees will be able to properly process any washing water and slops in order to prevent marine pollution.

Trainee demonstrates how to safely check the tank atmosphere to be cleaned prior to cleaning and understands why it is important.

### **Prerequisites:**

Familiarization exercises

Cargo discharging exercise

IG usage exercise

Theory of tank washing: principles, equipment, dangers, limitations, slop processing.

### **Simulator Condition:**

Cargo tanks empty and inerted.

Vessel ballasted to normal seagoing condition.

### **Briefing:**

Trainees to be explained which tanks to be washed and in which sequence.

Differences between water washing and crude oil washing to be explained.

Washing cycle system (open and closed cycle) to be explained.

**For table top exercise candidates to make a tank cleaning plan showing different stages of tank cleaning using bar charts.**

**Candidates to use the pumping, ventilation and tank cleaning plan to indicate proper lining up.**

## **EXERCISE NO.7: SETTLING AND DECANTING OF SLOP TANKS**

### **Objectives:**

Proper use of tank slop arrangement.  
Understanding of separation and settling of liquid mixtures having different densities.

### **Prerequisites:**

tank cleaning exercises  
Loading exercise  
Ballasting exercise  
Theory of tank loading alternatives  
Theory of oil/water separation.

### **Simulator Condition:**

Cargo tanks empty and inerted.  
Vessel ballasted to normal seagoing condition.  
Slop tanks full with oil/water mixture

### **Briefing:**

Trainees to be explained system of double slop tanks – primary and secondary.  
First settling to take place in primary tank, water then decanting to secondary tank and here further settling.  
Separated water then via ODME overboard if vessel underway (outside special areas).

**For table top exercise candidates to make a plan of the decanting process starting from completion of tank cleaning and ending with retention of only minimum slop for loading on top.**  
**Candidates to use the pumping and ventilation plan to indicate proper lining up.**  
**Loadicator to be used.**

## APPENDIX 3: CASE STUDIES

### Introduction

In this appendix, a few case studies on oil tanker accidents have been presented. The objective is to sensitize the students regarding the huge fallout of accidents on board a tanker, in terms of loss of life, property and coastal amenities, and subsequent expenditure of valuable resources in terms of economic cost of a cleanup.

Working on board a tanker is very serious business that requires a high degree of professionalism. Majority of incidents that take place on tankers, which in most cases result in a spill, can be avoided by following the basic rules of safety and ensuring that corners are not cut. It does not, after all pay to behave like a proverbial cowboy and taking unnecessary chances! By doing so, the shipboard personnel, especially the senior management on board would behave in an irresponsible manner. The point of continuous training is to make the student aware of the meaning of responsibility. When the essence of being responsible for one's operations comes from within, rather than being forced upon, it is the first step of safety culture on board.

Each case history is organized as follows:

- A list of headers that summarizes the spill name, location, product, and size of spill
- A brief incident summary including weather conditions and events leading up to the spill
- A description of the behavior of the oil including movement, evaporation, mousse formation, and dispersion
- A discussion of countermeasures and mitigation
- A description of other special interest issues such as communication problems, unusual hazards encountered, and large losses of organisms, as applicable.

The post spill scenario has been delved into in some detail, as compared to the incident summary, in order to make the seafarer aware as to how a small error in judgment on his/her part (be it in terms of navigation or cargo operation) can create a difficult situation for many others ashore.

## **CASE STUDY - 1**

### **EXPLOSION IN DOCKYARD**

#### **The Incident**

A small tanker went into a repair yard to have her starboard bow repaired. The vessel habitually carried premium motor spirit in all her cargo tanks and prior to arriving at yard had cleaned and gas freed the tanks by filling them to overflowing with seawater. Before hot work commenced the owners brought in a surveyor to test for explosive atmosphere and issue a gas free certificate. The certificate declared the vessel fit for hot work and indicated that all cargo tanks had been tested and found gas free. As shipyard workers started to cut away the damaged section, an explosion occurred in the forepeak tank, severely damaging the vessel and badly injuring two workers.

#### **Observations**

The explosion almost certainly occurred as a result of an accumulation of explosive vapours in the fore peak tank. The reason for the accumulation was never discovered. The cofferdam separating the forepeak tank from the cargo tanks was found to be clean, dry and free of cargo vapours. The incident highlights the desirability of testing the atmosphere in all enclosed spaces on tankers prior to commencing hot work.

In this case there was no formal contract between the vessel's owners and the repair yard. The question of responsibility for ensuring that the vessel was fit for hot work to be carried out was not clear.

#### **Root cause**

Insufficient safety procedures

#### **Financial cost**

The entire fore part of the vessel had to be replaced at the cost of USD 200,000/-. Claims by the injured workers were met by the shipyard's insurers. In addition to this surveyor's fees exceeding USD 4000/- were incurred.

**Source:** [www.shipownersclub.com](http://www.shipownersclub.com)

## **CASE STUDY - 2**

### **DEVIATION FROM AGREED DISCHARGE PLAN LEADS TO COCKTAIL**

#### **The Incident**

The vessel involved in this case is a coastal tanker carrying a full cargo of four grades of lubricating oil. The vessel arrived at the discharge berth where she was due to discharge into both shore tanks and barges moored alongside. After the ship was ullages and samples taken, a written discharge plan was agreed between the ship and terminal. The plan was signed by the ship's officers but retained by the terminal with no copy left on board. The details of the plan were recorded in the duty officer's notebook. It had been agreed that initially two parcels, 500 SN and 100 SN, would be discharged to the shore followed by 200 SN and 150 SN.

The 500 SN and 100 SN manifolds were prepared for the cargo hoses. After the 500 SN hose had been connected the jetty operator asked whether the second manifold was for 150 SN. The duty officer advised that it was the 100 SN manifold. The jetty operator told the duty officer that he wanted the 150 SN and not the 100 SN. The duty officer reminded the jetty operator that it had been agreed in writing that the 100 SN would be discharged before the 150 SN. Despite this the jetty operator continued to insist that he wanted 150 SN and as a result the manifolds were changed over and the hose connected to 150 SN manifold. Thereafter, the shore asked the vessel to stop despite the fact that there was approximately 70 metric tons left on board. On investigation it turned out that despite what the jetty operator had said, the terminal had been adhering to the original discharge plan with the result that 180 tons of 150 SN had been pumped into the wrong tank, contaminating the 220 tons of 100 SN it contained.

#### **Observations**

The vessel had followed the correct procedure up until the time the second cargo hose was connected. At that point the duty officer agreed to deviate from the written plan without proper authorization. If the officer on watch had insisted that a new cargo discharge plan had been drawn up or the original plan amended in writing, the confusion within the terminal would have become apparent and the contamination would have been avoided.

#### **Root cause**

Non-compliance with procedures

#### **Financial costs**

The shipowners and terminal operators negotiated a commercial settlement with the owners of the oil. The cost of investigating this incident and obtaining the legal advice on which negotiations were based amounted to USD 17000/-



## CASE STUDY - 3

### STATIC ELECTRICITY

**Case A.** The forward cargo tank of the MT XXX exploded while a surveyor measured cargo temperature prior to unloading, resulting in one death. The investigation team concluded that a steam leak in the tank caused static charge to be generated, that the charge accumulated on an ungrounded temperature probe and discharged as the probe was withdrawn from the tank, and that the resulting sparks ignited explosive vapours from the residue of the tank's previous cargo.

Investigator's recommendations addressed the foregoing items and other contributory factors:

- MT XXX's cargo tanks should have been inerted, the regulations states clearly that the inert gas system (IGS) should be used with all cargoes for Tankers > 20000 DWT. unless tanks are gas free.
- The main source of the explosive vapours was contamination of the cargo (No. 6 fuel oil) by previous condensate cargo, while release of light hydrocarbons by the No. 6 fuel oil may have been contributory.
- Masters of vessels carrying cargoes should certify that explosive vapours are not present prior to sampling or measuring cargoes with a combustible gas indicator device.
- The static charge was generated by a steam leak in the cargo heating pipes and accumulated on an ungrounded temperature probe. Better maintenance might have prevented the casualty.· The probe lacked a precautionary nameplate stating the, need for grounding the instrument during use.

**Case B.** The MT YYY, sailing in ballast, exploded and sank in the Gulf of Mexico with the loss of four lives. The Investigation concluded that the most probable cause of the explosion was the use of a steam driven gas freeing blower fitted with a long plastic sleeve in a non-gas free tank.

The ship had been carrying No. 2 fuel oil and gasoline. The tank in question had been washed, but not gas freed; an explosive mixture in the tank was possible. The probable cause of ignition was an incentive spark between the tank structure and charged steam condensate falling from the plastic sleeve through which the air was being driven.

The crew was unaware of the clear warning against the introduction of steam into potentially explosive atmospheres. The use of non-conductive material contributed to the accumulation of static charge.

From the foregoing mentioned 2 examples, it is clear that the problem of electrostatic discharge still exists in the oil shipping industry. All cases reviewed have in common the fact that primary or contributory causes occurred despite well documented precautions. Operators and other involved personnel, through errors of commission and omission, help foster the hazardous conditions required for electrostatic ignition accidents.

The applicable safety documents may vary in their approach to given safety issues, but enough information is certainly available to assure safe routine cargo tank operations. One goal of this project must be to ascertain whether an additional publication will have a positive impact in the industry.

### **The Four Conditions Required for Explosive Ignition**

The description of the required conditions for electrostatic hazard is:

The development of (static) electrical charges may not be in itself a potential fire or explosion hazard.

There must be a discharge or a sudden recombination of separated positive and negative charges. In order for static to be a source of ignition, four conditions must be fulfilled:

- (a) There must first of all be an effective means of static generation,
- (b) There must be a means of accumulating the separate charges and maintaining a suitable difference of electrical potential,
- (c) There must be a spark discharge of adequate energy, and
- (d) The spark must occur in an ignitable mixture.

### **Stages leading to a Hazardous Condition**

#### **Static generation**

Two differing substances in contact with each other will often become charged as one surrenders electrons to the other. Although the net charge remains constant, an electrical double layer is formed along the adjoining surfaces. The separation of the two substances often causes them to remain disparately charged, an effect which is exaggerated by increased speed of separation and increased mechanical work (friction)

Piping of oil products Charge generation and separation occur when liquids move in contact with other materials, as in operations involving piping, filtering, mixing or agitating. Mechanisms which exacerbate static separation in cargo loading operations are the following:

· Turbulence and splashing of the fluid at the beginning of tank loading operations when the pipe opening is not yet covered with cargo, especially since it is most likely at this time for water to mix with incoming oil.

- Any mixing or filtering of the cargo, particularly micropore or clay filtering.
- Impurities such as water, metals, rust, or other product in the cargo.
- Disturbance of water "bottom".
- Pumping of entrained air or other gases bubbling in the tank.

The cargo is also disturbed during unloading operations, as the fluid moves past hull structure, piping, etc., particularly during stripping when tank levels are at their lowest. Discharge of slops and contaminated ballast also generates high amounts of static charge.

**Displacing of lines** using air and water is a static charge generator.

**Water mist and steam Mists** formed during water washing or from the introduction of steam can become electrostatically charged. The charge associated with water washing may be much higher if cleaning chemicals are used.

**Steaming:** produces mist clouds much more highly charged than water washing, much more quickly, and can also cause the release of gases due to the heat and disturbance of the process.

Potentials are higher in large tanks than small ones, a fact born out by several serious accidents in the early VLCCs.

**Loading overall** (from the top of the tank): can deliver charged liquid into a tank which breaks up into small droplets and splashes into the tank. This can produce a charged mist and an increased hydrocarbon gas concentration.

**Air release in bottom of tanks:** Air or inert gas blown into the bottom of a tank can generate a strong electrostatic charge by bubbling action and agitation of the fluid.

**Crude oil washing (COW):** Mixtures of crude oil and water can produce an electrically charged mist if used for COW operations.

**Sloshing** Oil/bulk ore carriers (OBO): Single cargo holds extending the full breadth of the ship are subject to severe sloshing effects if not pressed full, leading to the possible formation of electrostatically charged mists. The sloshing can also produce free flying slugs of water in ballasted tanks, a spark producer under the right conditions and a hazard if flammable gases are present.

### **Accumulation of charge and potential**

#### **Static accumulator and non-accumulator oils**

The conductivity of a liquid determines whether or not it retains the generated static charge. A non-accumulator oil, defined by an electrical conductivity of greater than 50 (pS/m) will relax quickly because it transmits the charge to the steel hull, which is grounded in the water. Accumulator oils are defined as having a conductivity of less than 50 pS/m these oils relax (dissipate charge) slowly.

When accumulator oil is loaded, charges of similar sign repel from each other toward the liquid's outer surfaces, including that in contact with air. The latter is called the "surface charge" and is usually of most concern.

In general, black oils do not accumulate static charge and clean oils (distillates) do. It classifies several oils as follows:

#### **Non-accumulator oils**

- Crude oils
- Residual fuel oils\*
- Black diesel oils
- Asphalts

#### **Accumulator oils**

- Natural gasolines
- Kerosenes
- White spirits
- Motor and aviation gasolines
- Jet fuels
- Naphtha
- Heating oils
- Clean diesel oils
- Lubricating oils

## **Static discharge**

The cause and prevention of static discharge has drawn the most attention in the efforts to address this problem. Incendive sparks are those which release adequate energy to ignite flammable vapours. Spark energy may be reduced by physical factors such as electrode resistance, spark gap distance, and large gap areas. Discharges are sometimes in the form of a "corona", an ionization of gas which is not incendive but may precede an incendive spark.

Known causes of incendive sparks are identified below.

- Insulated conductors Unbonded, conductive objects in a cargo tank can accumulate available static charge and generate incendive sparks when discharging to another conductor, such as hull structure. They may be either trash or equipment unknowingly left in the tank or equipment introduced to do work in the tank
- Cargo measuring devices (ullage tapes, thermometers, gas sensors, etc.) present a particular hazard since they are often used during and immediately after cargo loading when some risk factors are at their highest. Use of these devices within a sounding tube is acceptable; electrical potential there is low because of its small volume and the shielding it affords from the rest of the tank.
- Falling water slugs The VLCC explosions in 1969 were blamed on washing water slugs accumulating charge as they fell through charged mists generated by the washing operation and discharging as they approached hull structure. Tank atmosphere control during water washing was recommended.

Other investigations established that slugs from smaller portable cleaning guns do not cause incendive sparks. The use of these machines in uncontrolled atmospheres is allowed.

**Flammable vapour** Oils give off hydrocarbon vapours whose flammable properties are described, in part, by the lower and upper flammable limits (LFL and UFL). LFL and UFL are the lowest and highest concentrations of the vapor in air that will ignite in the presence of an ignition source, otherwise known as the flammable range. Concentrations below LFL are too lean to burn and those above UFL too rich. Tank atmosphere control measures aim either to make the air/vapor mixture too lean or too rich.

Tank atmosphere is a constant concern regardless of the loading condition. Several factors can give rise to hazardous conditions, particularly as regards electrostatic discharge.

- Steam cleaning of tanks is necessary between some product loads and can release hydrocarbon gas in tanks thought to be gas free (5). This is due to the heat introduced by the process and the disturbance of sludge, clingage, rust particles, etc. on the surfaces of the tank. The released vapours are dangerous with the electrostatic charge caused by the steam and the contaminants in the wash by-product.

- Switch loading: The practice of using a cargo tank for different products in consecutive loads is called switch loading. Conditions for ignition may arise when a low-vapour- pressure static accumulator is loaded into a tank which previously held a volatile, high pressure cargo, even if no standing liquid from the previous load is present. Volatile gases may also be introduced if product piping lines were inadequately flushed between loads or if bypass piping arrangements allow inadvertent mixing.
- Temperature fluctuations: Hot/cold temperature extremes can result in locally hazardous conditions, e.g., when some cargo is heated by piping exposed to the sun. In such a case, much lower Reid vapour pressures result, with a possible increased risk of vapours within flammable limits.

**Loading Precautions The following are essential only when loading static accumulator oils (conductivity < 50 pS/m):**

1. Restrict initial loading rates, when splashing and surface turbulence occur, to flow rates less than 1 meter/second (volume flow rate conversions available). Adequate inlet coverage's are: side or horizontal entrance- 0.6 meter; downward pointing inlet- twice the inlet diameter.
2. Loading rate conversions tables are stated in the International Safety Guide for Tankers and Terminals (ISGOTT).
3. Restrict initial unloading rates to shore installations also, as long as inlets in the shore tank are not covered with liquid. The inlet fill pipe should discharge near the bottom of the tank.
4. Keep water and other impurities out of the incoming cargo stream as much as possible. Extra care with loading and unloading rates when presence of impurities (e.g., water, sulphur, metals) is suspected is essential.
5. Avoid pumping entrained gases with cargo.
6. Inerting a ship's tank eliminates loading rate restrictions due to static electricity.
7. Reduced pumping speeds are used for discharge of slops and other "mixed-phase flow" (some ballast) to shore tanks.

**Displacing of lines Clearing of cargo piping prevents cargo contamination (a suspected cause and its precautions):**

1. Asphalts and heavy fuels only may be cleared with air or inert gas.
2. Heavy fuels and crude oils may be cleared with water, which must thereafter be debottomed.
3. When necessary to use inert gas to displace clean products, a minimum amount must be used, particularly for aviation fuels.
4. Clean product lines should never be blown with air.
5. To clear water from a product line, pump twice the line fill volume of product at 3 ft/sec (fast enough to prevent water persisting at low points and at the correct speed to minimize static generation).

**Protection against mist and steam**

Steam must not be injected into the tank, particularly in an undefined atmosphere. Steam cleaning should be avoided unless absolutely required because of cargoes in tank.

Precaution for crude oil washing (COW): The use of "dry"-crude oil for COW is important in order to avoid electrically, charged mists sometimes produced by a crude oil and water mixture. Before washing begins, any tank which is to be used as a source of crude washing fluid should be partly "debottomed" to remove settled water. The discharge of a layer at least one meter thick (from the bottom) is necessary for this purpose.

Precaution for overall loading: Non-volatile petroleum at a temperature less than its flashpoint minus 10°C may be loaded overall if the tank is gas free and there is no contamination by volatile petroleum. Volatile petroleum or non-volatile petroleum which exceeds the aforementioned temperature must never be loaded in this manner.

### **Prevention of charge accumulation**

The following safety precautions have been developed to prevent the accumulation of static charge.

**Antistatic additives:** These additives raise the conductivity of a static accumulator; one specification calls for a minimum of 100 pS/m.

Treatment is required for these fuels minimum conductivity of 50 pS/m for static accumulating fuels, especially aviation fuels.

Safety precautions for the handling of static accumulating oils have been waived for those treated with antistatic additives.

### **Relaxation of static accumulators**

The charge which accumulates in a poorly conducting liquid will slowly dissipate after loading is completed and the cargo is still. Relaxation time of 30 minutes is recommended after loading of static accumulating oils before introduction of cargo sensors into the tank.

Tank washing: Prevention of static accumulation is critical during all tank washing operations because of the vigorous agitation of liquids involved. Detailed precautions for all tank atmosphere conditions are given in ISGOTT.

Water wash mixing of immiscible liquids is inevitable during water wash and is a source of static electricity. The following precautions apply, particularly in undefined or too lean atmospheres:

1. The tank should be kept drained during washing and washing stopped in case of water build up.
2. Recirculated wash water should not be used for tank cleaning.
3. Chemical additives in wash water must not be used in an undefined atmosphere.
4. The last cargo carried must be determined by examination of the Material Safety Data Sheet (MSDS).

### **Bonding and grounding**

The most important measure to prevent electrostatic hazard is to bond all metal objects together, eliminating risk of discharge between objects, and to assure that all components in the cargo handling system are at the same, electrical potential. Grounding to earth is not necessarily desirable for all forms of transport; airplanes and tank trucks are insulated from ground by their tires and may be at a vastly

different potential. In the case of tank vessels, grounding (or earthing) is effectively accomplished by bonding to the hull, which is naturally earthed through the water. Equipment should be designed to facilitate bonding and, in particular, to avoid the insulation of any conducting metal.

Bonding of cargo transfer piping Hoses used in terminal transfer operations must be continuously bonded, and grounded to the hull.

It is important to note that cargo transfer piping must be insulated from the land-side terminal since electrical potential may differ from that of the vessel due to stray current or cathodic protection of the pier. Insulating flanges, joints, or sleeves are sometimes used to divide the cargo hoses into electrically isolated halves - onboard and shore side. Each half is bonded and grounded to its respective base potential.

Dipping and ullaging When loading static accumulator oils, metallic dipping, ullaging, or sampling equipment must not be introduced or remain in the tank during loading, and for 30 minutes after completion of loading, to allow for relaxation of accumulated static charge. Bonded equipment which is grounded to hull structure may be used after the 30 minute stand down. Ropes used must be made of natural, not synthetic, fibre.

The foregoing precautions also apply during water washing of tanks in uncontrolled atmospheres and for five hours thereafter, which period may be reduced to one hour if the tank is continuously vented after washing.

Permanently fitted float level gauges do not present a hazard if they are properly grounded and the guide wires are intact.

### **Loose objects**

Every effort must also be made to ensure removing all loose objects from a tank and to prevent loose metal or objects from falling into a tank. , others

### **Free fall of liquid**

It is essential to avoid the free fall of water or slops in the cargo tank or a tank used for receiving slops.

### **Gas freeing**

Portable fans or blowers should only be used if they are hydraulically, pneumatically, or steam driven. Their construction materials should be such that no hazard of incendiary sparking arises if the impeller touches the casing.

Portable fans should be bonded to the deck. Air suction and discharge hoses should be bonded for electrical continuity to the hull.

### **Inert gas precaution**

If the inert gas plant breaks down during discharge, operations should be suspended. If air enters the tank, no dipping, ullaging, or sampling equipment should be introduced into the tank for at least 30 minutes, after which securely earthed equipment may be used; this restriction should be applied for five hours.

Carbon dioxide Carbon dioxide should not be injected into tanks which may contain flammable gas mixtures.

### **Conclusions and Recommendations**

1. A large body of safety guidance against the static electricity hazard is available to industry, but has not eradicated the problem, as indicated by a number of serious accidents.

2. Knowledge of static discharge safety by operators, seafarer's, tank cleaning personnel, and others is often deficient, as errors leading to recent accidents show.
3. Safety guidelines among existing safety publications are, for the most part, consistent but must be well understood and a part of Oil Tanker Training.

## **Part E: Evaluation**

The effectiveness of any evaluation depends to a great extent on the precision of the description of what is to be evaluated. The detailed teaching syllabus is thus designed, to assist the Instructors, with descriptive verbs, mostly taken from the widely used Bloom's taxonomy.

Evaluation/Assessment is a way of finding out if learning has taken place. It enables the assessor (Instructor), to ascertain if the learner has gained the required skills and knowledge needed at a given point towards a course or qualification.

### **The purpose of evaluation/assessment is to:**

- To assist student learning.
- To identify students' strengths and weaknesses.
- To assess the effectiveness of a particular instructional strategy.
- To assess and improve the effectiveness of curriculum programmes.
- To assess and improve teaching effectiveness.

The different types of evaluation/assessment can be classified as:

### **Initial/Diagnostic assessment**

This should take place before the trainee commences a course/qualification to ensure they are on the right path. Diagnostic assessment is an evaluation of a trainee's skills, knowledge, strength and areas for development. This can be carried out during an individual or group setting by the use of relevant tests.

### **Formative assessment**

Is an integral part of the teaching/learning process and is hence is a "Continuous" assessment. It provides information on trainee's progress and may also be used to encourage and motivate them.

### **Purpose of formative assessment**

- To provide feedback to students.
- To motivate students.
- To diagnose students' strengths and weaknesses.
- To help students to develop self-awareness.

### **Summative assessment**

It is designed to measure trainee's achievement against defined objectives and targets. It may take the form of an exam or an assignment. In Advanced Level



Courses, individual summative assessments are assigned and can be interspersed as appropriate throughout the course. As an integral part of the process, ALL have to be INDIVIDUALLY passed. Other exams, including a "Final Exam" may be added at the discretion of the instructor, but they cannot replace or offset any required assessment not passed by the Trainee.

#### **Purpose of summative assessment**

- To pass or fail a trainee
- To grade a trainee

#### **Evaluation for Quality assurance**

Evaluation can also be required for quality assurance purposes.

#### **Purpose of assessment with respect to quality assurance**

- To provide feedback to Instructors on trainee's learning.
- To evaluate a module's strengths and weaknesses.
- To improve teaching.

#### **Assessment Planning**

Assessment planning should be specific, measurable, achievable, realistic and time-bound (SMART).

Some methods of assessment that could be used depending upon the course/qualification are as follows and should all be adapted to suit individual needs.

- Observation (In Oral examination, Simulation exercises, Practical demonstration);
- Questions (written or oral);
- Tests;
- Assignments, activities, projects, tasks and/or case studies
- Simulations (also refer to section A-I/12 of the STCW code 2010);
- CBT;

#### **Validity**

The evaluation methods must be based on clearly defined objectives, and it must truly represent what is meant to be assessed, for example only the relevant criteria and the syllabus or course guide. There must be a reasonable balance between the subject topics involved and also in the testing of trainees' KNOWLEDGE, UNDERSTANDING AND PROFICIENCY of the concepts.

#### **Reliability**

Assessment should also be reliable (if the assessment was done again with a similar group/learner, would you receive similar results). We may have to deliver the same subject to different group of learners at different times. If other assessors are also assessing the same course/qualification as us, we need to ensure we are all making the same decisions.

To be reliable an evaluation procedure should produce reasonably consistent results no matter which set of papers or version of the test is used.

If the Instructors are going to assess their own trainees, they need to know what they are to assess and then decide how to do this. The *what* will come from the standards/learning outcomes of the course/qualification they are delivering. The *how* may already be decided for them if it is an assignments, tests or examinations.

The instructors need to consider the best way to assess the skills, knowledge and attitudes of our learners, whether this will be formative and/or summative and how the assessment will be valid and reliable.

All work assessed should be valid, authentic, current, sufficient and reliable; this is often known as VACSR – "valid assessments create standard results".

- Valid – the work is relevant to the standards/criteria being assessed;
- Authentic – the work has been produced solely by the learner;
- Current – the work is still relevant at the time of assessment;
- Sufficient – the work covers all the standards/criteria;
- Reliable – the work is consistent across all learners, over time and at the required level.

It is important to note that no single methods can satisfactorily measure knowledge and skill over the entire spectrum of matters to be tested for the assessment of competence.

Care should therefore be taken to select the method most appropriate to the particular aspect of competence to be tested, bearing in mind the need to frame questions which relate as realistically as possible to the requirements of the officer's job at sea.

### **STCW Code as amended in 2010**

The training and assessment of seafarers, as required under the Convention, are administered, supervised and monitored in accordance with the provisions of section A-I/6 of the STCW Code.

Column 3 - Methods for demonstrating competence and Column 4 - Criteria for evaluating competence in Table A-V/1-1-2 (**Specification of minimum standard of competence in advanced training for oil tanker cargo operations**) of STCW Code 2010 sets out the methods and criteria for evaluation.

Instructors should refer to this table when designing the assessment.

Instructors should also refer to the guidance as given in Part B-II/1 of STCW code, as given below;

### **Evaluation of competence**

*The arrangements for evaluating competence should be designed to take account of different methods of assessment which can provide different types of evidence about candidates' competence, e.g.:*

1. *direct observation of work activities (including seagoing service);*
2. *skills/proficiency/competency tests;*
3. *projects and assignments;*
4. *evidence from previous experience; and*
5. *written, oral and computer-based questioning techniques.*

*18. One or more of the first four methods listed should almost invariably be used to provide evidence of ability, in addition to appropriate questioning techniques to provide evidence of supporting knowledge and understanding.*

Assessment is also covered in detail in another IMO Model Course, however to assist and aid the Instructors, some extracts from the Model course is used to explain in depth.

### **Multiple choice questions**

Marking or scoring is easier if multiple-choice test items are used, but in some cases difficulties may arise in creating plausible distracters.

Detailed sampling allows immediate identification of errors of principle and those of a clerical nature. It must be emphasized that this holds true, in general, only if the test item is based on a single step in the overall calculation. Multiple-choice items involving more than one step may, in some cases, have to be resorted to in order to allow the creation of a sufficient number of plausible distracters, but care must be exercised to ensure that distracters are not plausible for more than one reason if the nature of the error made (and hence the distracter chosen) is to affect the scoring of the test item.

### **Compiling tests**

Whilst each examining authority establishes its own rules, the length of time which can be devoted to assessing the competence of candidates for certificates of competency is limited by practical, economic and sociological restraints. Therefore a prime objective of those responsible for the organization and administration of the examination system is to find the most efficient, effective and economical method of assessing the competency of candidates. An examination system should effectively test the breadth of a candidate's knowledge of the subject areas pertinent to the tasks he is expected to undertake. It is not possible to examine candidates fully in all areas, so in effect the examination samples a candidate's knowledge by covering as wide a scope as is possible within the time constraints and testing his depth of knowledge in selected areas.

The examination as a whole should assess each candidate's comprehension of principles, concepts and methodology; his ability to apply principles, concepts and methodology; his ability to organize facts, ideas and arguments and his abilities and skills in carrying out those tasks he will be called upon to perform in the duties he is to be certificated to undertake.

All evaluation and testing techniques have their advantages and disadvantages. An examining authority should carefully analyse precisely what it should be testing and

can test. A careful selection of test and evaluation methods should then be made to ensure that the best of the variety of techniques available today is used. Each test shall be that best suited to the learning outcome or ability to be tested.

### **Quality of test items**

No matter which type of test is used, it is essential that all questions or test items used should be as brief as possible, since the time taken to read the questions themselves lengthens the examination. Questions must also be clear and complete. To ensure this, it is necessary that they be reviewed by a person other than the originator. No extraneous information should be incorporated into questions; such inclusions can waste the time of the knowledgeable candidates and tend to be regarded as 'trick questions'. In all cases, the questions should be checked to ensure that they measure an objective which is essential to, the job concerned.

### **Advantages and disadvantages of oral and practical tests**

It is generally considered advisable that candidates for certificates of competency should be examined orally. Some aspects of competency can only be properly judged by having the candidate demonstrate his ability to perform specific tasks in a safe and efficient manner. The safety of the ship and the protection of the marine environment are heavily dependent on the human element. The ability of candidates to react in an organized, systematic and prudent way can be more easily and reliably judged through an oral/practical test incorporating the use of models or simulators than by any other form of test.

One disadvantage of oral/practical tests is that they can be time-consuming. Each test may take up about 1 to 2 hours if it is to comprehensively cover the topics concerned.

Equipment must also be available in accordance with the abilities that are to be tested. Some items of equipment can economically be dedicated solely for use in examinations.

In general, written exams are excellent forms to evaluate trainees' KNOWLEDGE, UNDERSTANDING AND PROFICIENCY of the concepts. However, if the goal is to evaluate a broad spectrum of material using only a sample of questions, care must be taken to protect the security of the exam from the trainees prior to the exam period. It is only natural for the trainees to focus on just the sample questions and not the broad spectrum of the material if the trainees have access to an exam prior to the exam period. It must also be noted that when training facilities use the same exams over multiple sessions of the same course, that it is nearly impossible to protect the security of the exam over an extended period of time; and therefore, training facilities/Instructors should adjust the questions and format of their exams at reasonable periods of time.

(Example Only\*\* Form of a Written Exam \*\* Example ONLY)

### TEST PAPER – 1 (ANSWERS)

TOTAL MARKS	:	100
PASSING MARKS	:	50%
DURATION	:	30 Min

(All questions carry 4 marks each)

**Note: Please do not write/mark anything on the question paper. Use the separate answer sheet provided for the evaluation.**

Q1.TICK THE BEST ANSWER FROM THE LIST PROVIDED.		Marks
1.	If the "Flash point" of an oil cargo is 58°C, it is said to be: a) Volatile    b) Non-volatile    c) Toxic    d) None of the above	
2.	Centrifugal pumps are started with the a) Suction valve shut    b) Discharge valve shut c) Drain valve open    d) None of the above	
3.	Black oils are generally: a) Static accumulators    b) Non accumulators c) Both    d) None of the above	
4.	Water extinguishes the fire by: a) Cooling    b) Smothering    c) Starving    d) Inhibiting	
5.	Inert Gas is a: a) Fire prevention medium    b) Fire Extinguishing Medium c) Both of the above    d) None of the above	
6.	If the ODME is not working an entry is required to be made in: a) Official log Book    b) Oil record Book c) Cargo log Book    d) IG log	
7.	The main purpose of the Deck water Seal is : a) Cool the I.G    b) remove impurities from I.G. c) Prevent backflow of gases    d) Maintains I.G pressure in the tanks.	
8.	VOC emissions can be reduced by shortening the duration of the washing or by using a _____ cycle crude oil washing programme. a) Closed    b) Open c) Either a or b    d) Doesn't matter	
9.	While doing COW the O2 Content in the tank being washed should not exceed: a) 8%    b) 11%    c) 10%    d) 21%	

10.	Before starting reciprocating pumps keep :			
	a) Suction valves shut		b) Discharge valves open	
	c) Pump/steam lines drained		d) (b) and (c)	
11.	A tank scope may be used to measure:			
	a) LEL	b) Percentage of LEL	c) % Vol of HC	d) % Vol of O <sub>2</sub>
12.	An Explosimeter should not be used in:			
	a) Inerted atmosphere		b) Non inerted atmosphere	
	c) Both of the above		d) None of the above	
13.	Which Annex of MARPOL deals with oil pollution :			
	a) Annex I	b) Annex II	c) Annex III	d) Annex IV
<b>Q2. WRITE THE FULL FORMS OF:</b>				<b>(4)</b>
a) SOPEP - Shipboard Oil Pollution Emergency Plan				
b) VRP - Vessel Response Plan				<b>(4)</b>
<b>Q3. Match the following pairs:</b>				<b>(40)</b>
A)	Anti Static Additive	X	Introducing IG in an Inerted tank to raise its pressure	<b>H</b>
B)	DCP	X	Time weighted average concentration	<b>E</b>
C)	Free fall	X	A permeable metal or ceramic mesh which cools a flame on its other side	<b>I</b>
D)	Pour point	X	Introduction of IG into a tank to reduce its HC content	<b>J</b>
E)	TLV	X	Unrestricted fall of liquid in a tank	<b>C</b>
F)	Viscosity	X	Substance added to a liquid to raise its electrical conductivity	<b>A</b>
G)	Flame arrestor	X	Lowest temperature at which oil will remain fluid	<b>D</b>
H)	Topping up	X	Repentance of a liquid to flow	<b>F</b>
I)	Flame screen	X	Flame inhibiting powder used in firefighting	<b>B</b>
J)	Purging	X	A portable fitted device of wire mesh used for preventing passage of sparks	<b>G</b>